

**eko
okna**



PRODUCT CATALOGUE



Product catalogue

We have made Eko-Okna S.A. a leading European manufacturer of window and door joinery. Since our beginnings, we have focused on the needs of all our customers, creating a product range that fully corresponds to the philosophy of the „one step shop“. With just a single delivery, you receive everything you need to complete your construction project. We offer windows, doors, sectional garage doors, sliding systems, shutters, external screens, facade blinds, insect screens and from the beginning of 2018 also fences. Everything is of the highest quality, because we only use materials from the best European suppliers.

We have four production halls, in which we manufacture all our products, each equipped with the most modern, fully automated production lines. The production process is supported by our qualified and experienced staff. Apart from the high quality of the product, we also offer support at every stage of the order process, including the delivery and unloading, with each of our trucks being equipped with a forklift truck.

The experience we have gained over the past 20 years allows us not only to respond to but also to anticipate the changes in the trends. We are extremely flexible, and our specialists focus on improving our products and our processes, meaning that we have the highest growth dynamics in Europe. We already export 85% of our products to 35 countries around the world. Our joinery is gaining recognition not only in Europe, but also in the United States and Australia.

108 000 m²
of production
space

350
trucks

35
export
markets

7 days
to fulfil typical
orders

CONTENTS



6



**A WIDE RANGE
OF PRODUCTS**

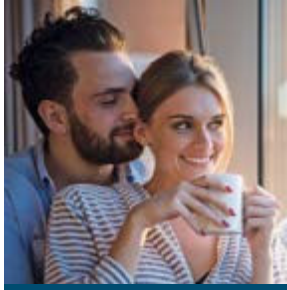

26



**GEALAN
SYSTEMS**



34



**SLIDING
SYSTEMS**

50



**HARDWARE
AROUND THE WINDOW**



58



**AVAILABLE COLOURS
OF THE PVC JOINERY**

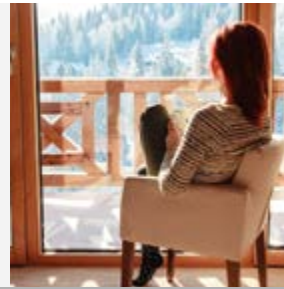

66



**PVC
ENTRANCE DOOR**

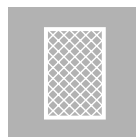

70



**EKOLINE
PANELS**

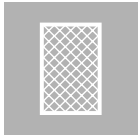

76



ACCESSORIES
AND ADDITIONS



92



ALUMINIUM
SYSTEMS



104



DESPIRO
DOORS

110



WOODEN WINDOWS
NATURO



116



PRODUCT LINE
ALL IN ONE DESIGN



124



SAFEHOME
FENCES



132



COOPERATION
WITH BENEFITS





A WIDE RANGE OF PRODUCTS

Today we offer many window and door systems, based on PVC, aluminium and wood. We also offer sliding systems, shutters, sectional garage doors and insect screens. Everything is of the highest quality, because we only use materials from the best European suppliers.



**eko
OKNA**

Ideal 70



10

minimum glazing
thickness (mm)

40

maximum glazing
thickness (mm)

2

gaskets

5

chambers (frame)

70

installation depth (mm)



The system is distinguished for its many advanced design features, enabling simple and economic manufacturing and installation. The IDEAL 70 a considerable degree advanced design will definitely prove its outstanding features, allowing the system to stride current trends and potential future requirements of UK Building Regulations.



A wide range of glazing options between 10 mm to 40 mm



Compatible with the entire Aluplast range of products



The finished window looks identical viewed from inside or outside



Fused gaskets allow faster and efficient installation, eliminating the problem of gasket shrinking



Allows fabrication both outward and inward opening Windows, all internally glazed



An extensive array of ancillary extension and connector profiles



Ideal 4000

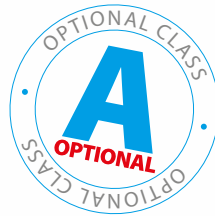

1.0

U_w for U_g=0.8
warm spacer bar*

1.4

U_f

2

gaskets

5

chambers (frame)

70

installation depth (mm)



This universal system works well with modern architecture, for single-family and multi-family homes, as well as during the renovation of older property.

* U_w for the reference window



Glazing packages up to 41 mm wide



Standard mechanism to prevent an incorrect handle position (side-hung casement windows)



Standard hardware equipped with two anti-burglary points per sash



Recommended for multi-family housing



Aluskin aluminium covers can be used



On a white or brown core



Ideal 4000 Casement



steel

Reinforcement system

40

maximum glazing
thickness

2

gaskets

5

chambers (frame)

70

installation depth (mm)

class profile B



The system has been designed with the view to meet all requirements defined both by clients and construction law regulations. A simple profile shape is its characteristic feature. The system gives great design possibilities.



Various window combinations are possible thanks to a large variety of available additional profiles, fasteners and extensions.



The system of protective glazing beads conforms to Secure by Design and PAS24 requirements.



Windows based on the Ideal 4000 Casement system ensure very good thermal insulation properties.



An ideal solution both for residential and public utility buildings.



External seals eliminate the effect typical for older sealing systems, and prevent any clearances or gaps in seal corners.



The system gives great design possibilities. Similarly to Ideal 70, it comes in 41 colour versions



Ideal 4000 NEW



class profile B

1.00

U_w for U_g=0.8
warm spacer bar*

1.3

U_f

2

gaskets

6

chambers (frame)

85

installation depth (mm)



The combination of our most popular solution with a six-chamber frame construction allows significantly improved thermal insulation of the window.

* U_w for the reference window



Glazing packages up to 41 mm wide



Standard mechanism to prevent an incorrect handle position (side-hung casement windows)



Standard hardware includes two anti-burglary bolts per sash



Recommended for multi-family housing



Available with a simple or semi-surface sash



On a white or brown core



Ideal 5000



0.87

Uw for Ug=0.6
warm spacer bar*

1.2

Uf

3

gaskets

5

chambers

70

installation depth (mm)

class profile B



Windows that combine modern design with very good technical parameters. A system featuring triple sealing. Also available in a version with a lower frame.

* Uw for the reference window



Glazing packages up to 41 mm wide



Standard mechanism to prevent selection an incorrect handle position (side-hung casement windows)



Standard hardware includes two anti-burglary bolts per sash



Aluskin aluminium covers can be used



Possibility of using the innovative V-Perfect technology



The hardware operates in a dry chamber that ensures longer service life



Ideal 7000 NEW



0.90

Uw for Ug=0.7
warm spacer bar*

1.1

Uf

2

gaskets

6

chambers

85

installation depth (mm)

class profile B



A completely new and ground-breaking approach to energy efficiency. The steel reinforcement in the frame can be replaced with Ultradur High Speed thermoplastic inserts.

* Uw for the reference window



Glazing packages up to 51 mm wide



Standard mechanism to prevent selection an incorrect handle position (side-hung casement windows)



Standard hardware includes two anti-burglary bolts per sash



Recommended for energy efficient buildings



Possibility of using the Ultradur High Speed reinforcement in the frame



On a white or brown core



Ideal 8000



class profile B

0.74

Uw for Ug=0.5
warm spacer bar*

1.0

Uf

3

gaskets

6

chambers

85

installation depth (mm)



The latest generation
in windows.
When selecting them
– you choose warmth,
silence and style.
Windows based on
the Ideal 8000 system
provide thermal and
acoustic insulation at
the highest level.

* Uw for the reference window



Glazing packages up to 51 mm wide



Standard mechanism to prevent selection an incorrect handle position (side-hung casement windows),



Standard hardware includes four anti-burglary bolts per sash



Possibility of using the innovative V-Perfect technology



Aluskin aluminium covers can be used



On a white or brown core



Ideal 8000 Energeto



class profile B

0.72

Uw for Ug=0.5
warm spacer bar*

0.94

Uf

3

gaskets

6

chambers

85

installation depth (mm)



We replace steel with plastic and paste the glass into the wing. The warmest window in the most modern version. As standard, windows made based on the Energeto 8000 system are made in V-Perfect technology.

* Uw for the reference window



glazing with packages up to 51 mm wide



in the standard blockade of the incorrect position of the handle



six anti-burglary points in the standard



panes paste to the wing using the „bonding inside“ technology



possibility of mounting Aluskin covers



profiles available in the classic-line style



Renovation systems

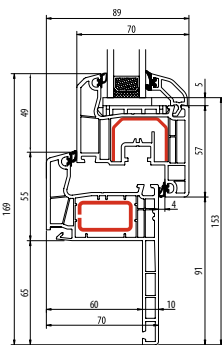
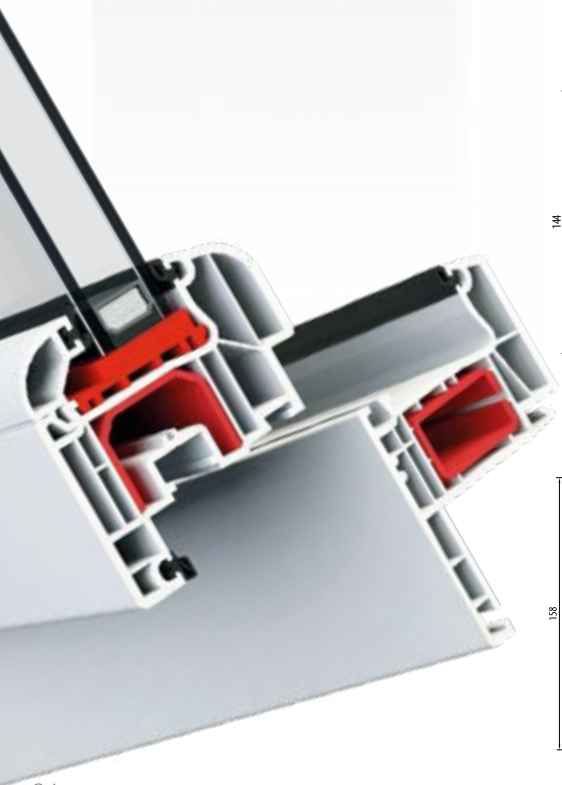

Ideal 4000 reno 65 Soft-line

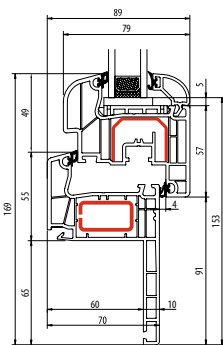

Ideal 4000 reno 65 Round-line

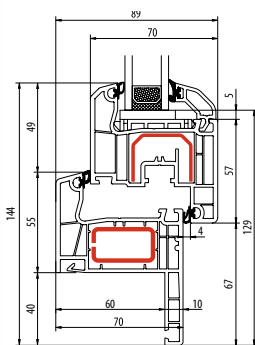

Ideal 4000 reno 40 Soft-line

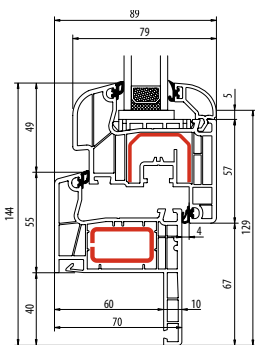

Ideal 4000 reno 40 Round-line

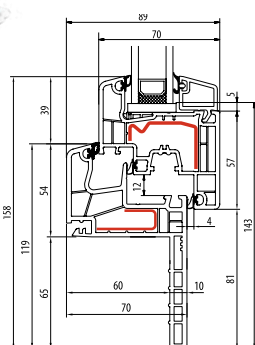

Ideal 5000 reno 65 Classic-line

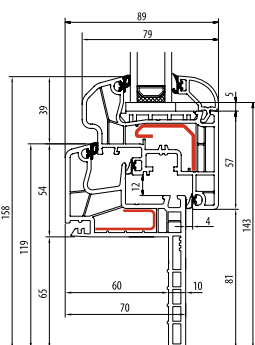

Ideal 5000 reno 65 Round-line



What we offer is fully adapted to the requirements of particular European markets.



The renovation windows and doors from our range are designed not only for assembly in historic buildings. They are often chosen simply by anyone seeking to replace their joinery without first having to dismantle the old jambs.

Renovation joinery is characterized by a special frame with what is called a masking section, which creates a stylish band from the inside. The elements of the old frame are masked with special angle sections. From the outside, however, it is possible to use enclosing profiles.

Renovation strips are available in different widths. In addition, we can trim the element according to the needs of the design.

GEALAN SYSTEM

The system creates great opportunities. Building depth allows to install glass packages with a width of even 54 or 52 mm. Innovative solution used in this system is dry gluing STV technology. Profiles are coated with acrylcolor surface - the most durable material in the world.





еко
окна

S 9000



class profile B

0.69

for $U_g=0.5$
warm spacer bar*

0.91

U_f

3

gaskets

6

chambers (frame)

82,5

building depth (mm)



The best statics, energy-saving profile, possibility to build larger structures without the need to install crossbars, glazing using STV technology, acrylcolor coating - these are just some of the advantages of S 9000 revolutionary system.

* U_w for the reference window



glazing with 26-54 mm packages (glazing with STV technology)



possibility to use moveable post



six anti-burglary points per window sash



glazing with the STV technology only in windows



V-Perfect in standard



possibility to stain the profiles surface with the acrycolor technology



HEAT TRANSFER COEFFICIENT

U_w for reference window
with dimensions 1.23 x 1.48 m,
manufactured by Eko-Okna

FOR WARM SPACER BAR

	U _f	U _g = 1,1	U _g = 1,0	U _g = 0,9	U _g = 0,8	U _g = 0,7	U _g = 0,6	U _g = 0,5
		U _w =	U _w =	U _w =	U _w =	U _w =	U _w =	U _w =
Ideal 4000	1,4	1,30	1,20	1,10	1,10	-	-	-
Ideal 5000	1,2	1,21	1,14	1,07	1,00	0,94	0,87	0,80
Ideal 7000 new	1,1	1,17	1,11	1,04	0,97	0,90	0,84	0,77
Ideal 8000	1,0	1,14	1,07	1,01	0,94	0,87	0,80	0,74
Ideal 8000 Energeto	0,95	1,13	1,06	0,99	0,92	0,86	0,79	0,72

FOR ALUMINUM SPACER BAR

	U _f	U _g = 1,1	U _g = 1,0	U _g = 0,9	U _g = 0,8	U _g = 0,7	U _g = 0,6	U _g = 0,5
		U _w =	U _w =	U _w =	U _w =	U _w =	U _w =	U _w =
Ideal 4000	1,4	1,40	1,30	1,20	1,20	1,10	1,00	-
Ideal 5000	1,2	1,30	1,24	1,17	1,10	1,03	0,97	0,90
Ideal 7000 new	1,1	1,27	1,20	1,14	1,07	1,00	0,93	0,87
Ideal 8000	1,0	1,24	1,17	1,10	1,04	0,97	0,90	0,83
Ideal 8000 Energeto	0,94	1,22	1,15	1,08	1,02	0,95	0,88	0,81

Glasses

The specific construction of composite glass and the possibility of combining it into different packages allow the right window properties to be achieved. Thermal comfort, depending on the needs, is provided by two or three glass layers. Safety is guaranteed by the anti-burglary film, and an interesting appearance by the use of ornamental glass.

Our range includes various configurations of glazing:



Thermal insulation
(1-chamber)

Standard, single-chamber composite glass consisting of two float glass panes.



Thermal insulation
(2-chamber)

Double-chamber glass increases the thermal comfort of the interior. The second chamber creates an additional barrier to prevent heat from escaping.



Soundproof

The glass has been designed to increase the acoustic comfort of our interiors, and is also exceptionally soundproof.



Secure

A laminated glass, which if broken retains the pieces of glass on the film layer.



Sun protection

A sun protection glass, characterized by excellent parameters, reducing the amount of solar energy that enters the rooms through the façade of the building.



Anti-burglary

A special, multi-layered glass construction where the types of glass used provide protection against burglary and acts of vandalism.





Our windows can be equipped with glazing of various widths and numbers of glass layers (for four-glass glazing). The outer glass layer always has a low-emission coating, thanks to which the windows achieve even better thermal insulation properties.

SLIDING SYSTEMS

Sliding systems enable the use of impressively large glazing areas. This allows us to achieve extraordinary aesthetic effects and illuminate the interiors. They are also very convenient to use.



**eko
okna**



Easy SLIDE

A Duo Slide system means that doors can successfully substitute traditional window systems. The door can slide on one or two guiding rails. Glazing packages up to 19 mm wide allow the use of a double-glazed package. The design limit for this system is 60 kg per sash.

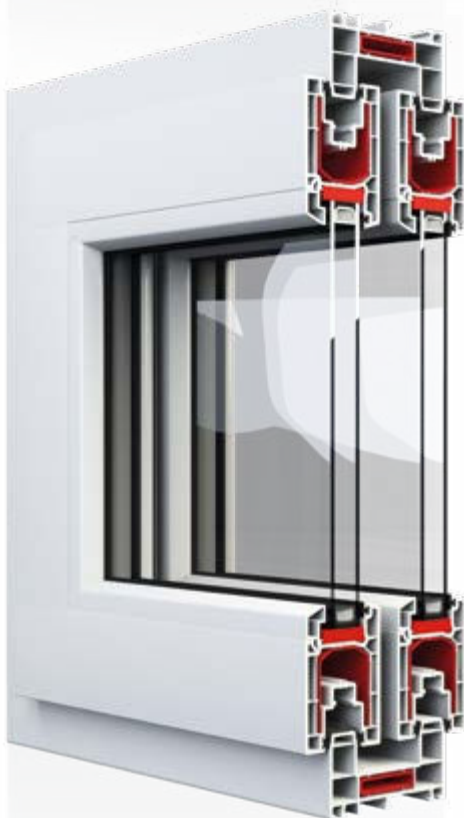

Multi SLIDE

Sliding doors based on the Multi Slide system provide optimal thermal protection, guaranteed partly by the possibility of glazing packages of up to 33 mm wide. The sashes can slide on two or three guide rails. The construction of a multi-rail structure is possible thanks to the use of a special jamb profile, which acts as an additional guiding rail.





Cost-effective solutions that can successfully replace balcony windows, for greater convenience. Sliding systems also save space in rooms and guarantee good thermal protection.

Aluplast HST 85 / 70

Energy efficient sliding door system. Enables to create large glazed structures, while still maintaining excellent thermal insulation.

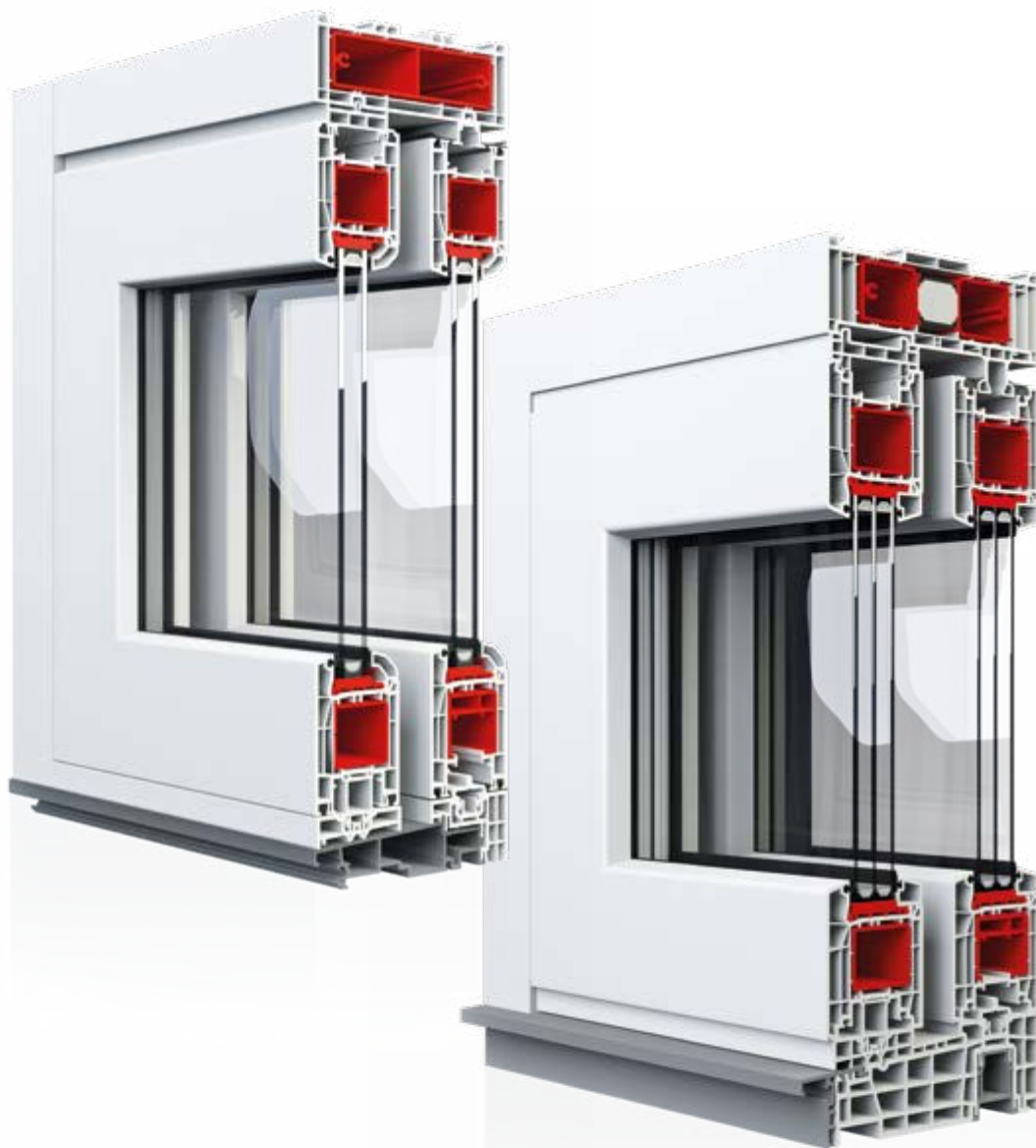

HST 85 systems are large glazed lift and slide doors. The maximum width of the set is up to 6.7 m, while the maximum allowable sash dimensions are 3x2.5 m. Characterised by great functionality and good parameters, they constitute an excellent solution for single-family housing. This type of door forms an interesting alternative to traditional balcony or terrace doors. Available with a door frame depth of 85 or 70 mm.



HST 70

HST 85

HST 70

HST 85

installation depth

167
mm

197
mm

max. construction dimension (white)

6500
x 2500
mm

6700
x 2700
mm

glazing with glass packages with a width of

10-41
mm

20-51
mm

max. dimension of the sash

3000
x 2500
mm

3000
x 2500
mm

max. weight of the sash

400
kg

400
kg

Aluskin aluminium covers



EvolutionDrive 82

A lift and slide door system that allows production of large glazing while maintaining good thermal parameters. A characteristic feature of the system is possibility of being equipped with a low threshold that allows use of "barrier-free construction" solutions, used in hospitals or other public facilities.





Doors built based on the evolutionDrive 82 system are characterised by unusually good thermal parameters. The width of 82 mm allows for the installation of wide packages with three glass panes.

82
mm

sash width

5

chambers
(frame and sash)52
mmglazing with packages
up to 52 mm
(3-pane package)194
mm

building depth

Smart Slide

Sliding doors based on the Smart Slide system thanks to a simple and innovative closing mechanism allow for simple and intuitive operation, similar to the solutions used in lift and slide doors.





Smart Slide is a sliding door, but the innovative closing mechanism allows for simple and intuitive operation, similar to the solutions used in lift and slide doors. The TPE gaskets were used here, which resulted in a much higher thermal insulation coefficient than in other sliding doors.

The wing in Smart Slide can reach up to 1.5 x 2.3 m.

41
mmglazing with
packages up to140
mm

building depth



EkoSun HST

EkoSun HST is an amazing convenience and ability to create spacious, glazed structures. The low profile guarantees maximum light flow and at the same time ensures waterproofness at the highest level.

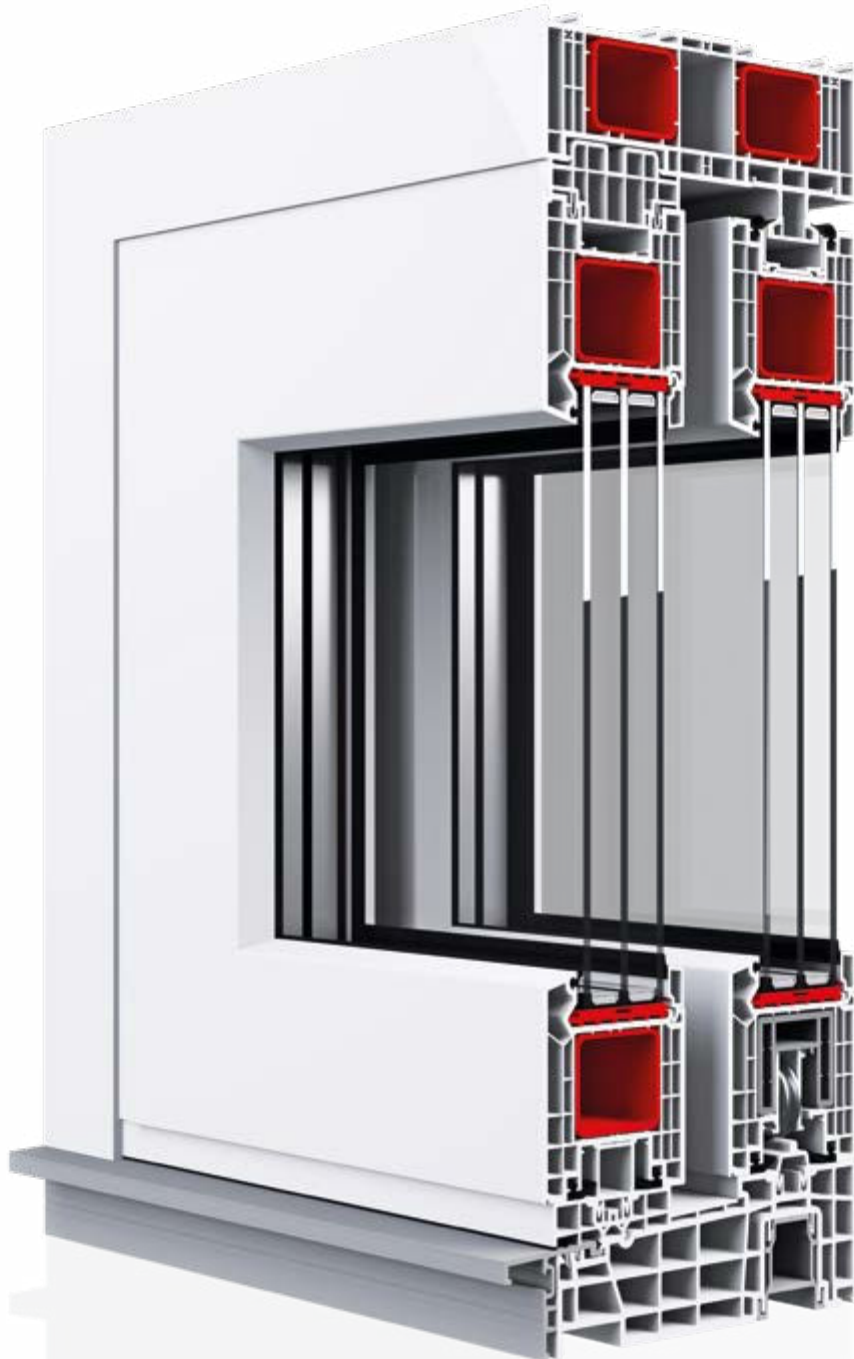



Technical specification:

- profile height 100 mm
- maximum load capacity of the wing 400 kg
- maximum construction height 3 m
- rail height – 13 mm
- wide range of veneers
- possibility of using energy-saving glass sets up to 54 mm

Folding system

A stylish way of providing access to a garden, terrace, or balcony. Our folding systems are very easy to use, at the same time act as a unique decorative element. Available in a wide variety of colours.

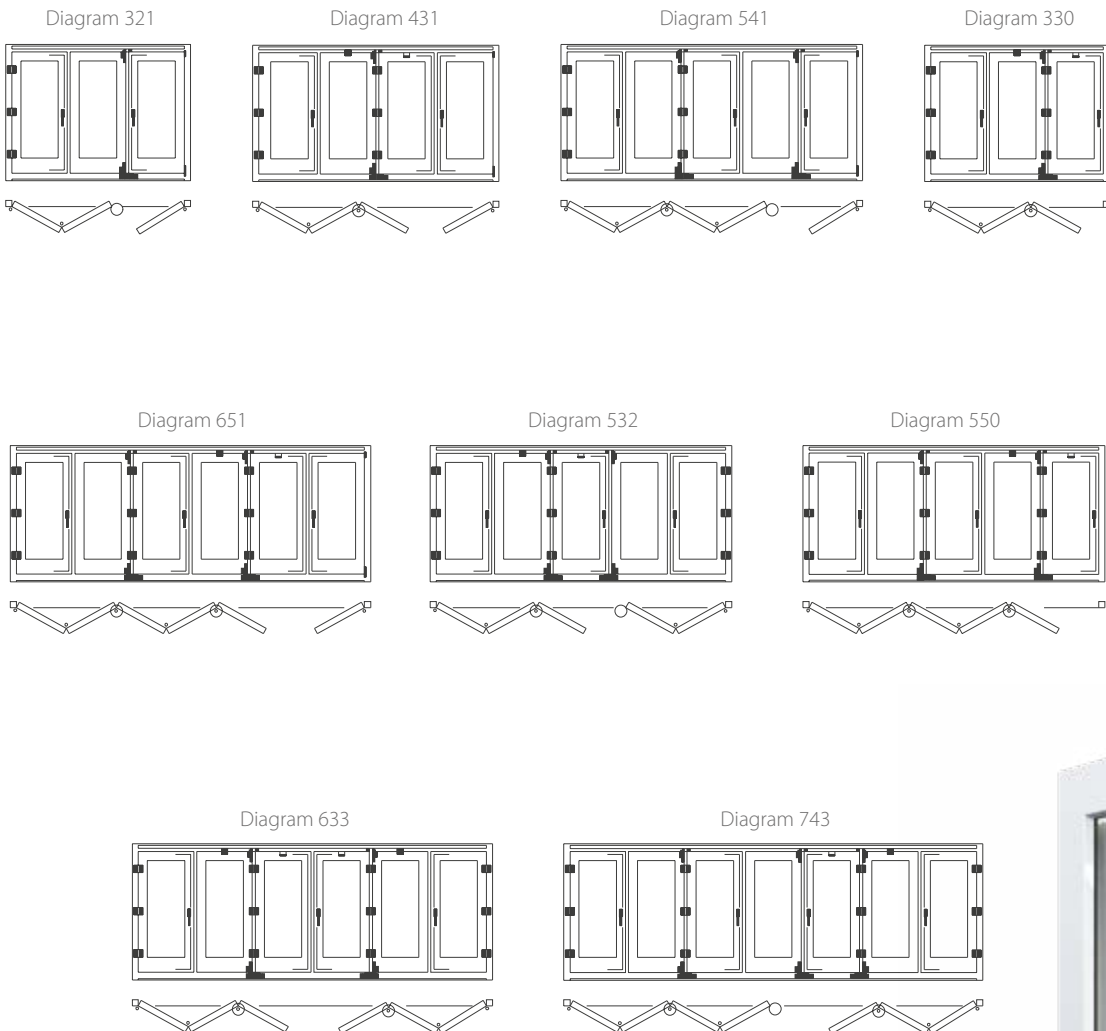

The hardware for folding structures creates great possibilities. They are equipped with rollers in trucks located in the upper and lower sections of the structure. The hardware enables to produce structures up to 5300 mm long, where each leaf can weigh up to 130 kg. Folding doors consist of two parts: a side-hung (or tilt and turn) unit and two or more leaves that fold by moving sideways.



max. weight of the sash



rollers



max. width of the structure



hinges with covered screw adjusters to make vertical and horizontal



adjustment easy, with quiet sliding of the sashes



rollers with insulation made of PVC

PSK

Tilt and slide doors are an interesting alternative to balcony windows. They allow both sliding and tilting of the active sash. Tilt and slide doors can be manufactured based on any PVC window and door profile from our range.



Tilt and slide doors are an interesting alternative to traditional double-sash balcony doors. They are also an affordable alternative to lift and sliding systems. The ergonomic design of the handle makes it easy to open and close the door with one hand.



200
kg

maximum weight
of the sash

1600
x 2400
mm

max. dimensions
of the sashes
of the terrace doors

2
sashes

one active and one
passive sash

1300
x 2400
mm

max. dimensions
of window sashes

aluplast®

SALAMANDER
INDUSTRIE//PRODUKTE

HARDWARE AROUND THE WINDOW

Window fittings from the recognised international Maco manufacturer, based on the highest quality steel. Fittings are configured based on the weight and size of the sash, as well as the function that the window is to fulfil. The basic elements of the fittings we use fit all windows from our range.



**eko
okna**

Standard Aluplast

(Ideal 4000 / Ideal 5000 / Ideal 7000)





- ❶ Anti-burglary latch
- ❷ Window latch
- ❸ Lifter latch
- ❹ Anti-burglary pins (iS)
- ❺ Hung closure horizontal
- ❻ Espagnolette bolt
- ❼ Lifter of the espagnolette
- ❽ Tilting shear
- ❾ Corner
- ❿ Middle closure
- ⓫ Top hinge
- ⓬ Bottom hinge

Standard Salamander

(also in Ideal 8000)





- ① Anti-burglary latch
- ② Window latch
- ③ Lifter latch
- ④ Anti-burglary pins (iS)
- ⑤ Hung closure horizontal
- ⑥ Espagnolette bolt
- ⑦ Lifter for the espagnolette
- ⑧ Tilting shear
- ⑨ Corner
- ⑩ Middle closure
- ⑪ Top hinge
- ⑫ Bottom hinge

Anti-burglary hardware

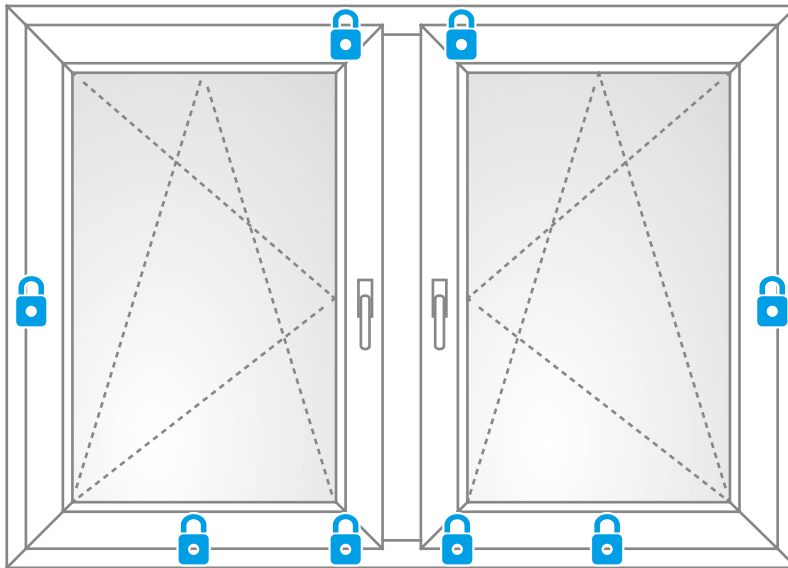

RC1

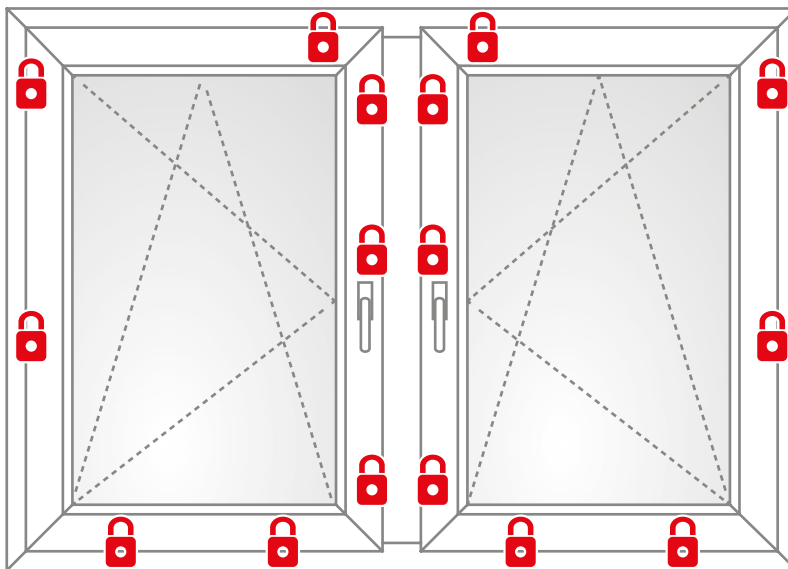

RC2*

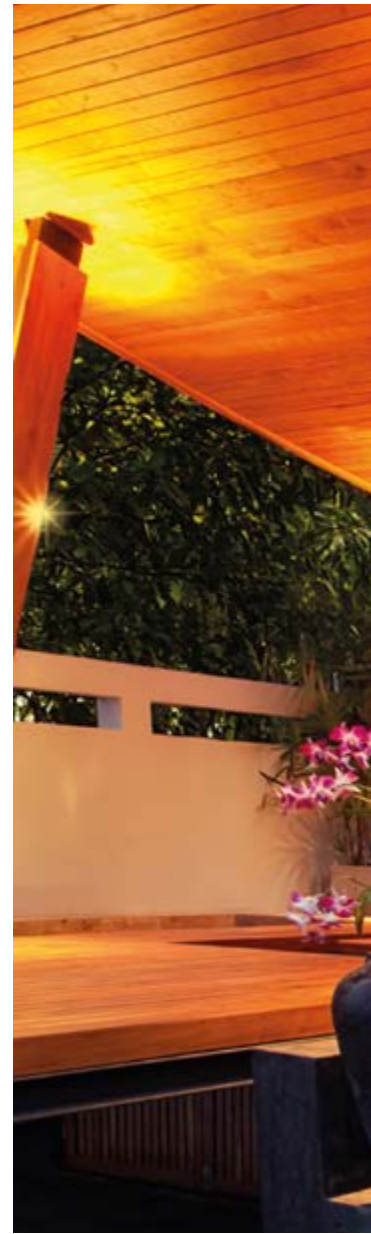

The number of anti-burglary latches depends on the construction and the dimensions of the window.



We offer windows featuring the RC1 and RC2 anti-burglary classes to those who especially value their safety and that of their loved ones. Technologically refined solutions are the best barrier against burglars.

* The example applies to a window measuring 1465 x 1435.

AVAILABLE COLOURS OF THE PVC JOINERY

Windows are becoming a very common decorative element, both of the entire exterior and interior of a building. The basic method is to choose the colour and structure of the veneer. We offer a wide variety of smooth and wood-like colours.



**eko
okna**



Special oak AP 01

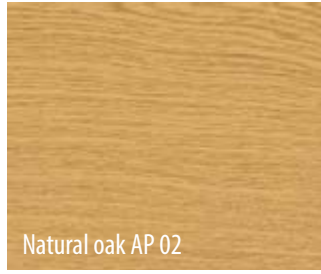

Natural oak AP 02



Mahogany AP 05



Dark oak AP 06



Daglezja AP 11



Oregon III AP 15



Turner Oak Malt AP 19



Sheffield Oak Alpine AP 20

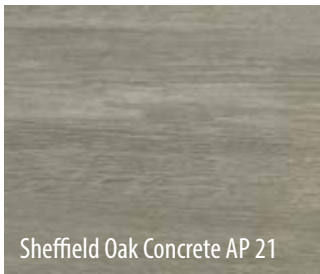

Sheffield Oak Concrete AP 21

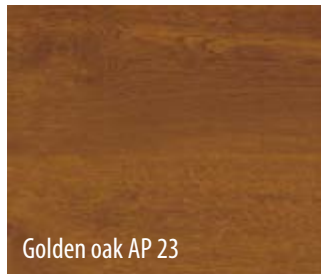

Golden oak AP 23

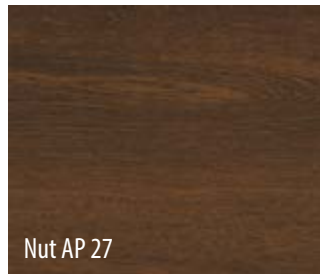

Nut AP 27

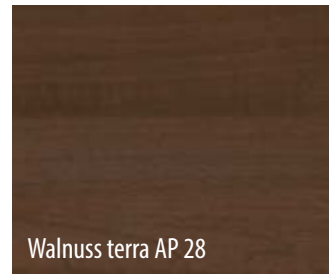

Walnuss terra AP 28



Walnuss amaretto AP 29

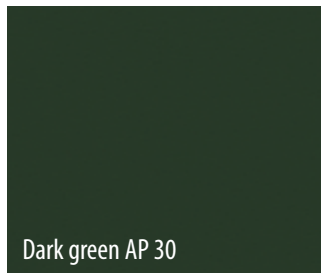

Dark green AP 30

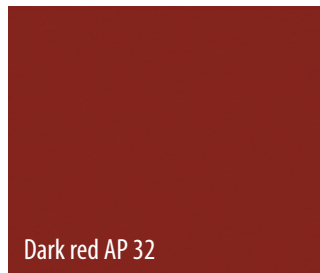

Dark red AP 32

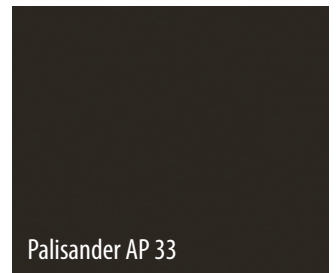

Palisander AP 33

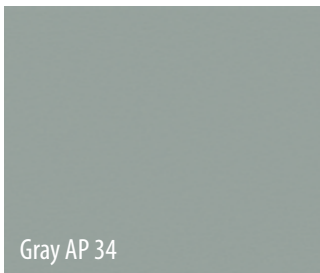

Gray AP 34

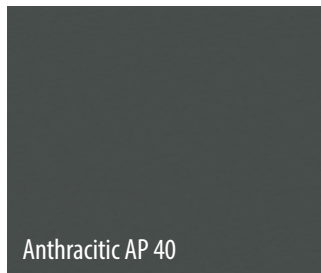

Anthracitic AP 40



Steel blue AP 41

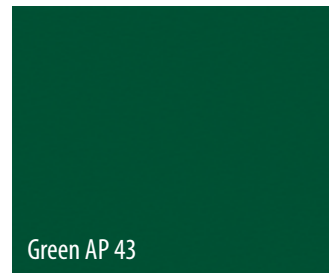

Green AP 43

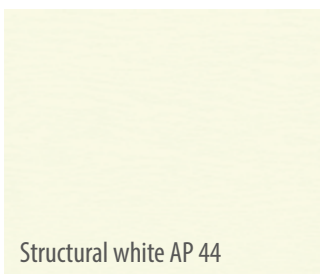

Structural white AP 44

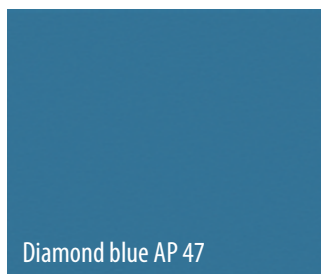

Diamond blue AP 47

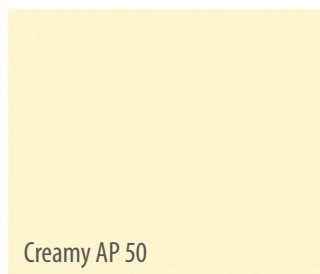

Creamy AP 50

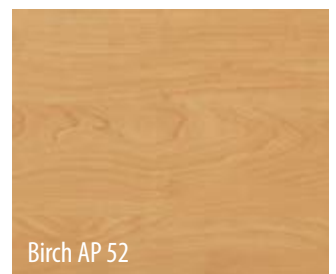

Birch AP 52

Colour palette

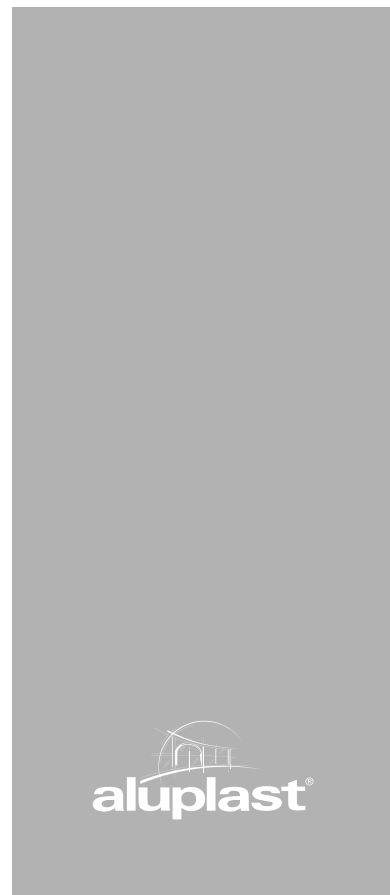
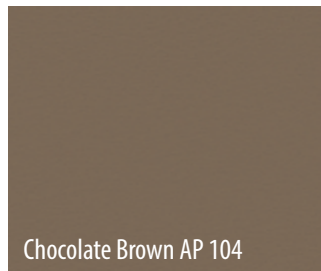
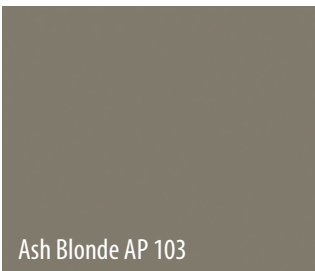
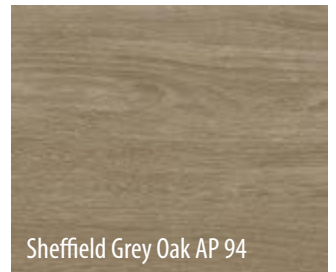
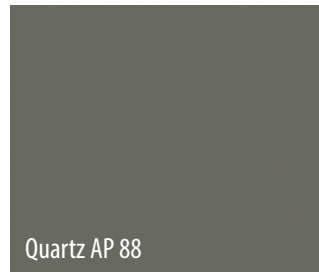
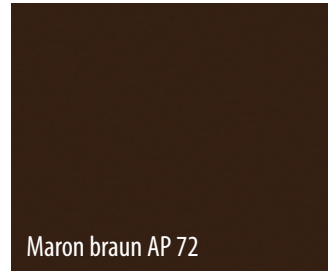
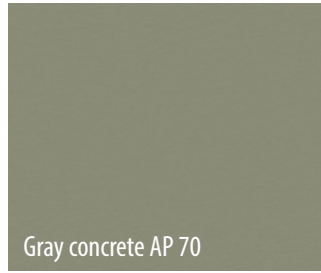
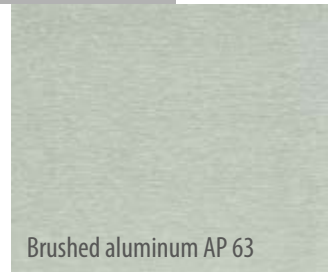
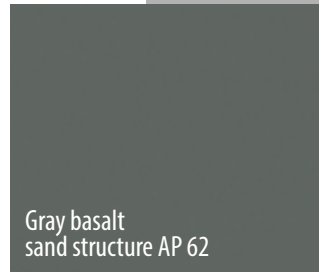
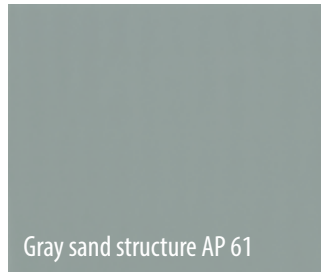
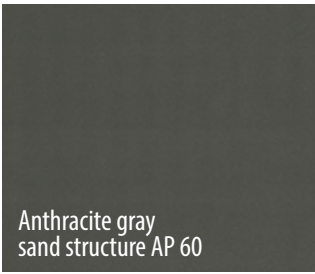



Grey SAL 02



Dark green SAL 03



Steel blue SAL 11



Jet Black Mat SAL 18



Burgundy Red SAL 19



Nut SAL 21



Swamp oak SAL 25



Mahogany SAL 26



Douglas SAL 27



Winchester SAL 33



Alux DB 703 SAL 37

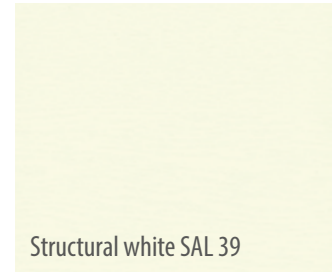

Structural white SAL 39



Sheffield Grey Oak SAL 41



Sheffield Light Oak SAL 43



Mountain pine SAL 50

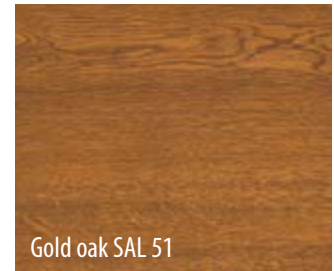

Gold oak SAL 51



Oregon 4 SAL 52

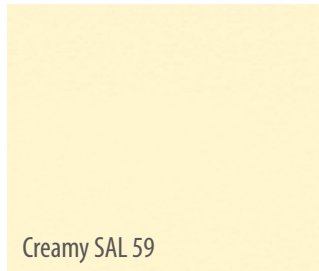

Creamy SAL 59



Vermont SAL 60

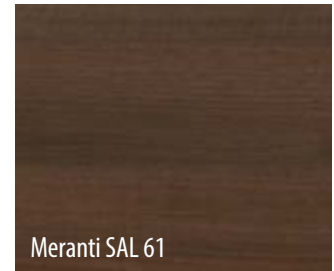

Meranti SAL 61

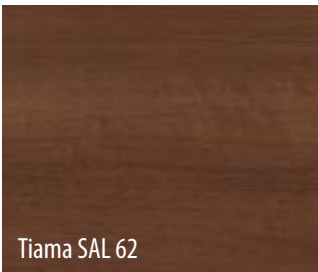

Tiama SAL 62

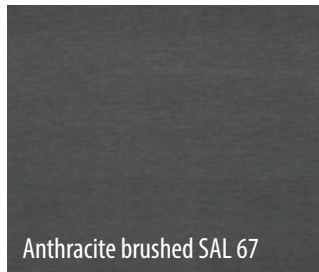

Anthracite brushed SAL 67



Aluminium brushed SAL 69

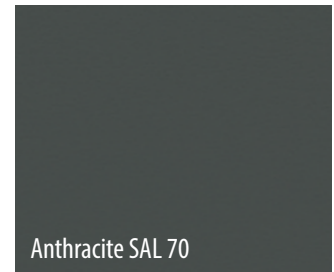

Anthracite SAL 70

Colour palette

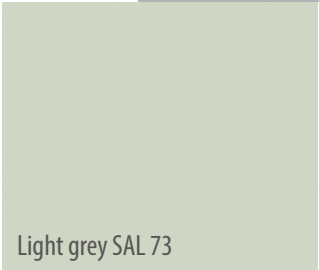

* Colours in the catalogue may differ from the actual ones.
When choosing a colour, please use the colour templates.

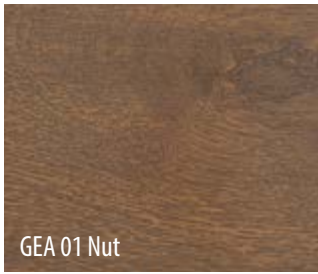

GEA 01 Nut



GEA 02 Gold oak



GEA 03 Mahogany



GEA 04 Anthracitic



GEA 07 Anthracite sanded



GEA 08 Mountain pine



GEA 09 Light oak



GEA 11 Creamy deko



GEA 12 Grey deko



GEA 13 Winchester



GEA 16 AnTeak



GEA 17 Dark oak



GEA 19 Basalt grey

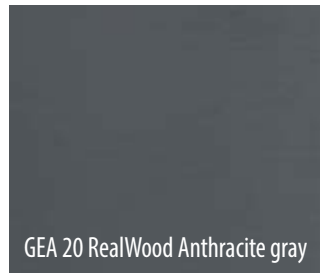

GEA 20 RealWood Anthracite gray



GEA 21 Whitewashed oak

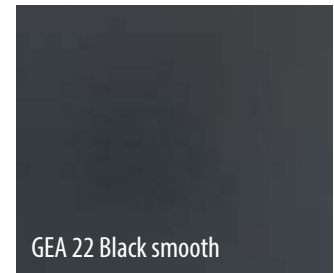

GEA 22 Black smooth

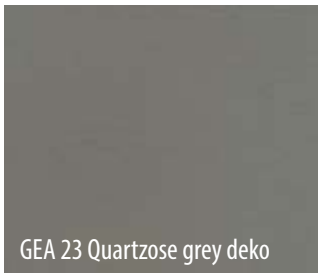

GEA 23 Quartzose grey deko

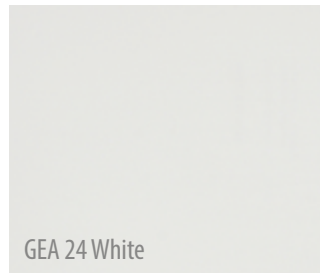

GEA 24 White

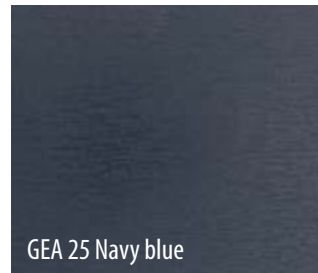

GEA 25 Navy blue

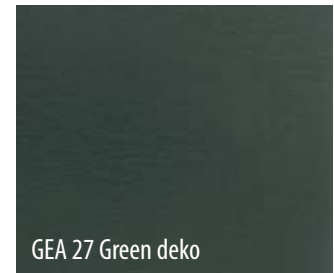

GEA 27 Green deko

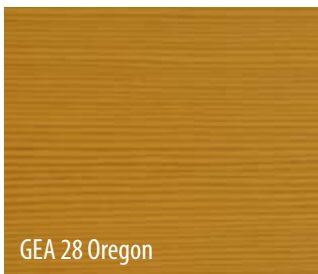

GEA 28 Oregon



GEA 30 Siena PN Noce



GEA 31 Douglas

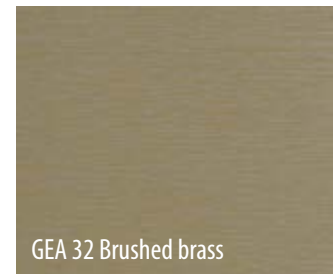

GEA 32 Brushed brass

Colour palette

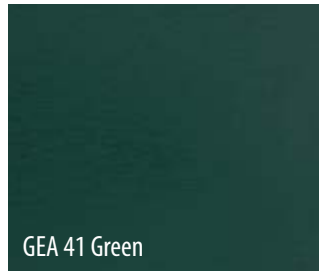
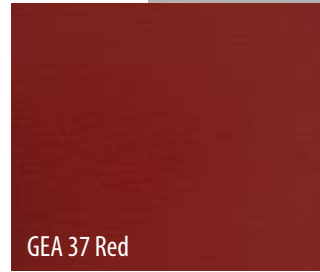

DB 703	RAL 7015
RAL 7016	RAL 7039
RAL 7040	RAL 8014
RAL 9005	RAL 9016
SILBER	

ACRYLCOLOR

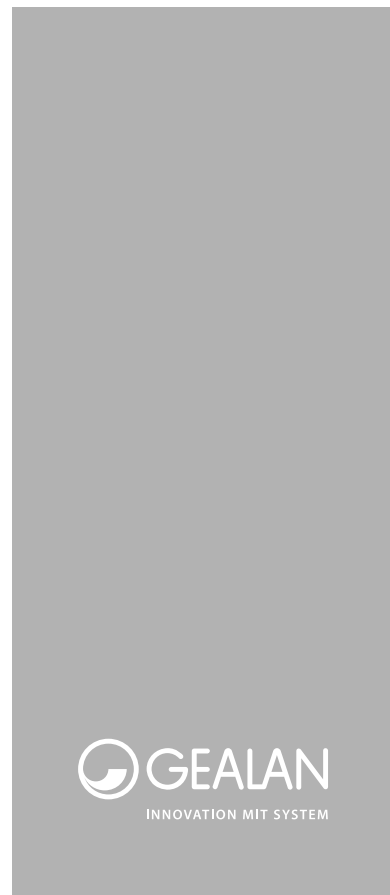



PVC ENTRANCE DOOR

The wide catalogue of doors that we offer allows to select the optimal solution for your home. We offer doors based on wood, aluminium and PVC. Complemented with panels with the warmest filling on the market, they are an ideal barrier against weather conditions and noise.



**eko
okna**

PVC entrance door

The entrance door is the showcase for every home – it emphasizes both the character of the building and its owner. Our company gives you full freedom to choose the design, colour and creation of the entrance door, based on the Streamline 76, BluEvolution 92 and Ideal 4000 profiles.

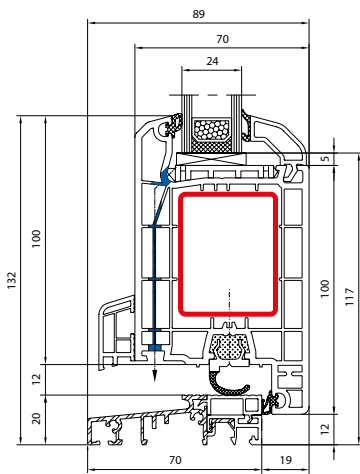

Ideal 4000

- opening to the outside
- opening to the inside

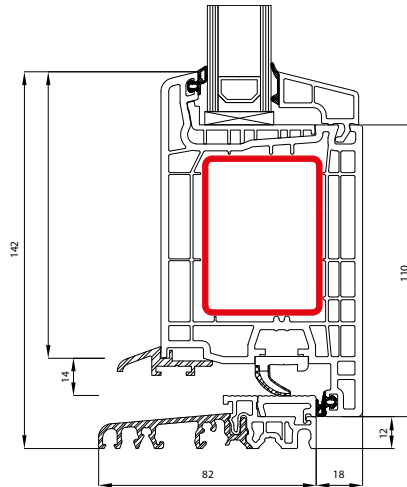

Streamline 76

- opening to the outside
- opening to the inside

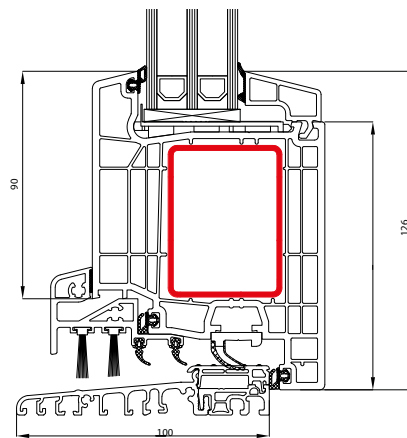

BluEvolution 92

- opening to the outside
- opening to the inside

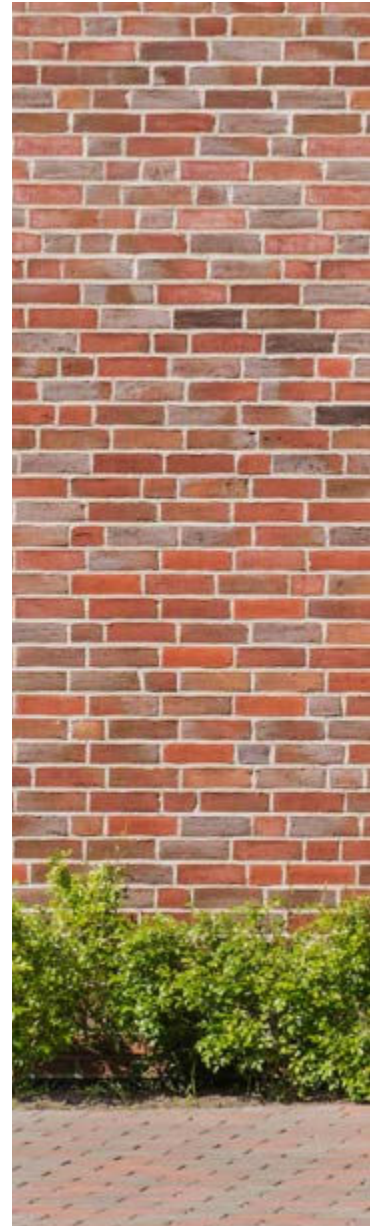

You can choose one out of dozens of designs we offer or create your own. The doors are available in the full colour range.



safety



aesthetics



quality

EKOLINE PANELS

Modern design, freedom in the selection of accessories and a diversity of colours make the EkoLine door panels a unique showcase of every home. The highest quality materials we use in the production are a guarantee of safety and durability for many years.





**eko
okna**

EkoLine panels

Stainless steel adornments

Modern architecture is primarily based on simple geometric forms. When choosing a door, people often look for models with glazing with regular shapes and stainless steel adornments.

Stainless steel adornments flush with the surface of the panel

The stainless steel is flush with the surface of the panel. This solution is especially recommended for anyone who is not only considering the appearance of the door panels, but also their practical aspects. Flush adornments are much easier to maintain.

Grooved panels

For anyone who is seeking panels with more subdued decorations, we recommend our grooved door panels. Grooves give the door an original look and create a noticeable and spatial structure.





EkoLine

Door hardware

The doors are equipped with the highest quality in multi-point locks and espagnolette bolts. As standard, we offer an espagnolette bolt equipped with two hooks and two bolts, which is operated by turning the key in the main lock. Optionally, the door can also be equipped with an automatic espagnolette bolt.



Doors are an effective barrier against a burglar only if all hardware elements exhibit a similar level of security. The standard door hardware is based on a three-point espagnolette bolt and hinge system. However, if this is insufficient, then it becomes necessary to uprate it with additional elements.



- | | |
|---|-----------------------|
| ① Operating the lock | ⑤ Polyurethane foam |
| ② Anti-burglary pins | ⑥ Hinges |
| ③ Lock cassette | ⑦ Lock |
| ④ High pressure laminate plate or glass | ⑧ Main latch |
| | ⑨ Upper, bottom latch |

For anyone who cares about safety we recommend equipping the door, in particular, with anti-burglary pins, an electric door striker or a door closer. This set complements multi-point locks.

ACCESSORIES AND ADDITIONS

The accessories not only add to the appearance of the joinery, as they also add functional advantages. Joinery for the windows and doors should primarily be functional. Thermal insulation and insulation, in the case of windows, can be ensured by the selection of appropriate types of glass. The security of the joinery also depends on the selection of door handles and hardware.



**eko
okna**

Warm spacer bar

The use of an inter-glazing warm spacer bar allows up to 10% in savings on energy expenditures. In addition, spacers raise and balance the temperature on the inner surface of the glass, which prevents condensation appearing on the edges of the glass.



Ornamental glass panes

Ornamental glass is perfect for both indoor and outdoor structures, giving great design possibilities. Recommended for houses, offices, shops, hotels, and restaurants.

The best choice for partition walls, bathrooms, doors and windows. Provides intimacy and brightens the interior.



Delta matt, white



Chinchilla, white

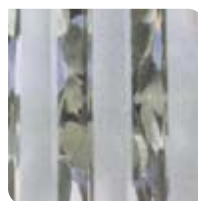

Flutes matt, white



Silvit white



Satinovo matt



Altdeutsch white



Abstracto white

Aluminium covers

Complement your window profiles with external aluminium covers, not only to increase the aesthetic values of the windows, but also their durability. Aluminium covers give the windows an unusual and interesting look. They allow to combine the practical advantages of PVC windows with the modern design of aluminium windows.

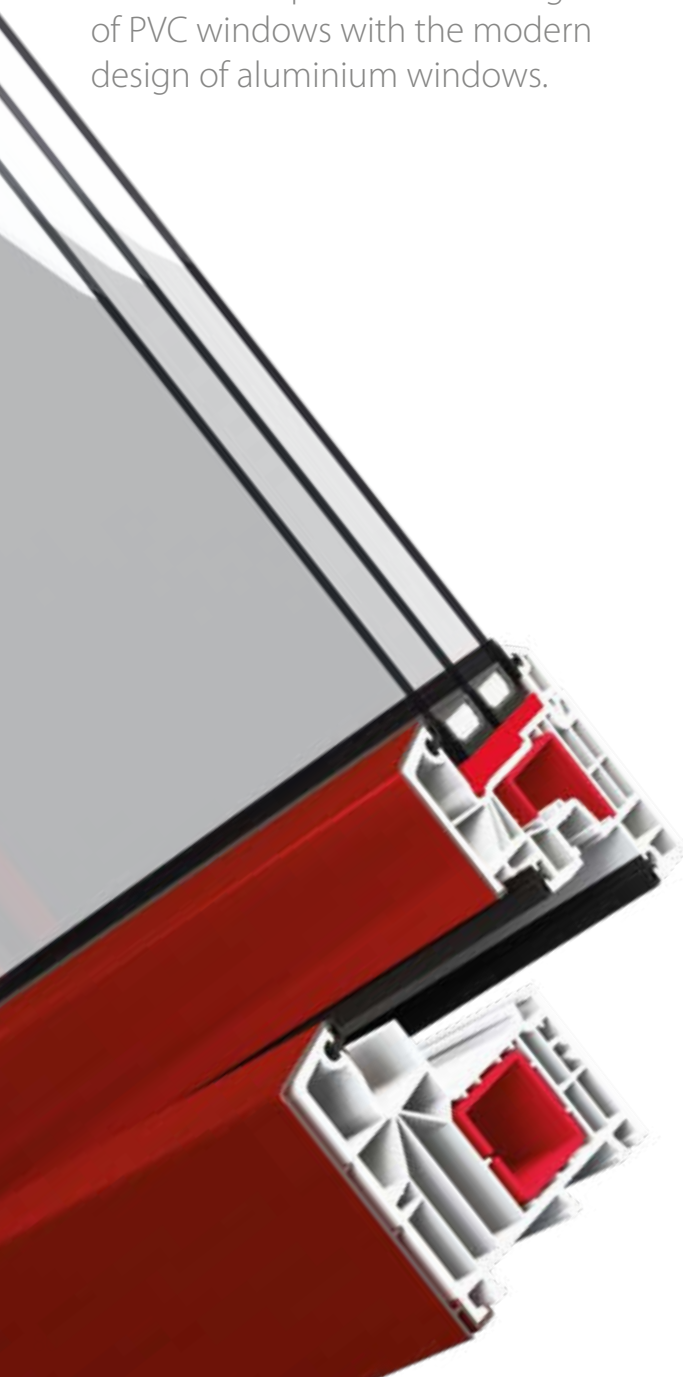

Ideal 4000



Ideal 5000

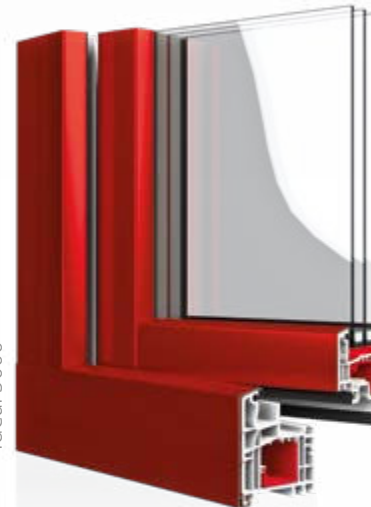

Ideal 8000





HST 85

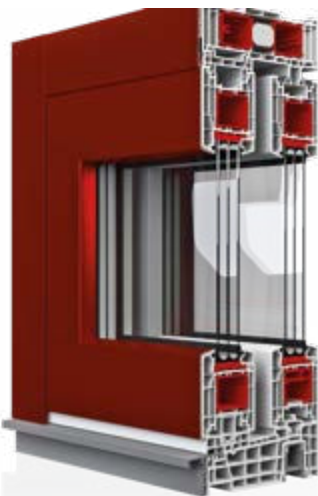

Streamline 76



Handles

Window handles made of PVC and aluminium, available in a wide range of colours. They not only serve protection, but also complement the appearance of the window and the style of the interior.

We offer standard handles as well as those with a locking button, allowing the use of a key. They are all available in many colours, making it easier to match their appearance to that of the window.



Door pulls and door handles





HST
door
handles





Handles

Standard handle aluminium

PVC	ALU	WOOD
<input checked="" type="checkbox"/>	<input checked="" type="checkbox"/>	<input type="checkbox"/>

- white
- brown
- caramel
- silver
- titanium
- cream

MACO handle

PVC	ALU	WOOD
<input checked="" type="checkbox"/>	<input checked="" type="checkbox"/>	<input type="checkbox"/>

- white
- brown
- caramel
- silver
- titanium
- cream
- matt gold





HOPPE SECUSTIK handle

PVC	ALU	WOOD
<input checked="" type="checkbox"/>	<input checked="" type="checkbox"/>	<input type="checkbox"/>

- white
- brown
- caramel
- silver
- titanium
- cream
- matt gold



MOONLINE HANDLE

PVC	ALU	WOOD
<input checked="" type="checkbox"/>	<input type="checkbox"/>	<input type="checkbox"/>

- white
- brown
- złota
- silver
- titanium



NEW YORK SECUSTIK HANDLE

PVC	ALU	WOOD
<input checked="" type="checkbox"/>	<input checked="" type="checkbox"/>	<input type="checkbox"/>

- white
- silver
- gold
- cream
- marron



ROTO HANDLE

PVC	ALU	WOOD
<input checked="" type="checkbox"/>	<input checked="" type="checkbox"/>	<input type="checkbox"/>

- shiny gold
- matt gold



Pulls and door handles

Selected models

Available colours: white, brown, cream, silver, and gold.

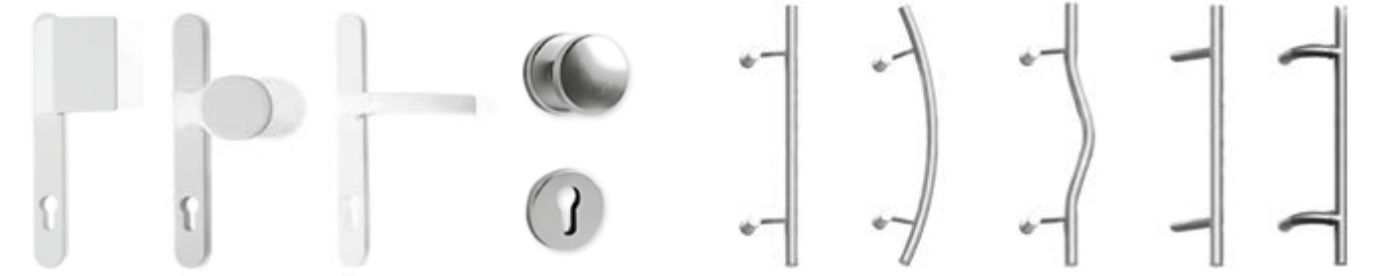

London Knob Door handle Double-sided knob P5 P1 P8 P45 P60



New in the offer - black accessories which quality meets the highest European standards.

Thanks to them, your windows will acquire an original character and a unique look. Accessories are made of aluminum, then powder coated in a shade of black, or coloured in bulk - in the case of PVC products.

Vents

Vents are one of the most important elements of the ventilation system, especially when gravity or mechanical exhaust ventilation systems are used in the rooms. The vents become the only source of fresh air.

Radaks vent

A compact trickle vent that provides a constant stream of fresh air and reduces indoor humidity. A perfect solution specifically for mould-infested rooms. The humidity is reduced conveniently without the need to open the window, which is a great advantage in winter. Easy to install, easy to operate, and easy to clean.



AERECO EMM 707 vent

A handy and highly recommended trickle vent that can be set to blow air upwards or at an angle. This trickle vent features an air flow angle lockout and requires no manual adjustment, since it has a control sensor based on a polyamide band. The air flow rate is adjusted according to the indoor humidity. Requires no electrical power supply.



AMO vent

The popular self-regulating vent that can set the air flow in a vertical or horizontal direction. The air flow rate depends on the indoor relative humidity.



Ventair vent

Designed to provide fresh air at a steady and sufficient flow rate with the help of a dedicated air flow capacity stabilizer that is especially useful in winter. A perfect solution for improved indoor comfort, health effects, and heating efficiency.



Slimline 2000 vent

A high-quality self-regulating trickle vent. Combines a modern design style with a high functionality. Prevents high humidity and mould attack in rooms, while providing a flow of fresh air. Can be sealed off by hand.





They ensure the constant access of air, thanks to which no moisture is created in the interior.

This is a convenient way to ventilate rooms without having to open any windows, which is especially important in winter.

Muntin bars

Muntin bars give the windows an elegant and unique character, and in some cases constitute an indispensable decorative element referring to an older architectural style. They are available in many widths and colours.



Glued muntin



Inglass muntin



Viennese muntin





Aesthetics

Muntin bars are used in housing construction mainly due to their aesthetic values.

They create divisions that make the window more attractive and give it an original look. They are also a great way to keep the appearance of the small divisions typical of old windows, while using larger, comfortable window sashes.

PVC window sills

External window sills

– the system combines aesthetics with the highest quality. Their smooth surfaces are easy to clean, and are resistant to impacts and scratches. Available in various colours, lengths and widths.



External window sills

Window sills are available in aluminium or steel. They are characterized by very good quality and resistance to weather conditions. They are stylish, durable, non-flammable, and resistant to moisture and chemicals. Thanks to the drip edges, they form the perfect protection for the façade.





Chamber internal

These are made of hard polyvinyl chloride, the same used to manufacture PVC windows and doors. Coated with a film featuring high resistance to scratching and UV rays. The chamber cross-section ensures rigidity of the structure. Window sills made of hard PVC are an alternative, durable, moisture-resistant product. Available colours: golden oak, walnut, alder, marble and white.



ALUMINIUM SYSTEMS

Until recently, aluminium joinery was only used in public buildings. Today, we can see it being used increasingly often in residential buildings.

Windows made of aluminium ensure durability and certainty, with many years of trouble-free use. In addition to aluminium windows, we also offer aluminium doors, sliding and folding systems, internal partitions as well as façade systems.





eko
okna

Double Hung VS 600



Vertical sliding windows VS 600 – new in our offer. It is a traditional style of casement windows combined with the advantages of a modern aluminum profile, guaranteeing the best thermal parameters. Double Hung windows can be glazed with two and three pane packages.



The system is equipped with a high-quality seal and hidden dehydration. The VS 600 system has great structural capabilities. In addition to the vertical sliding sash, it has a "tilt" function that makes it easier to clean windows.

The outer frame with a square cross-section and wing connections, which require minimal processing, considerably simplify the assembly of windows.

MB-59S CASEMENT



50

Depth of frame
(door / window) (mm)

59

Depth of leaf
(door / window) (mm)

100

Max weight
(door / window) (kg)



This type of windows is intended to be mounted both in wall openings and in mullion-transom facades. The construction is based on the window/door system with a MB-59S thermal break. The structural depth of the window sections is equal to 50 mm for frames and 59 mm for casements. The profiled „omega“-shaped thermal breaks of the width of 16 mm and 22 mm, made from polyamide reinforced with fibreglass are applied.



The MB-59S CASEMENT system is intended for production of tilt windows and windows opening outwards – the economical ones and possessing good functional qualities at the same time.

The structures based on this system are characterized by both high aesthetics and the good functional qualities:

- the surfaces of internal frame and the casement lie in one plane,
- window gaskets are barely visible from the outside,
- gaskets are mounted in a continuous manner, without cutting in the corners, what significantly shortens the mounting time and improves the tightness,



Panorama



74,5

frame depth (mm)

5,5

maximum structure
width (m)

50

max. thickness
of glazing (mm)



A technologically advanced system intended for production of accordion doors. Consisting of thermally insulated aluminium profiles, the system looks aesthetic and provides good thermal insulation.



All aluminium systems offered by our company are available in two colour palettes – RAL and DECORAL. We supply anodised windows and doors as well. Such a large selection enables you to choose perfect windows to match both the interior and the façade.

Application:

- standard glazing package 4/16Ar/4th [Ug=1,1]*
- three-chamber profile structure
- thermal break width – 24 mm
- two-colour structures available
- varnishing in RAL palette colours is available

*Standard of the day 16.04.2019. Requires technological confirmation.

MB-86



77

frame installation
depth (mm)

86

sash installation
depth (mm)

58,5

max. thickness
of glazing (mm)



Recommended for energy efficient buildings. The system gives you great design possibilities. It is durable, resistant and is an excellent thermal and acoustic insulator. Using it, we can manufacture doors up to 3 metres tall.



One system, multiple possibilities. Without using elements from any other systems, we are able to produce windows, doors, windows with concealed sashes, and even aluminium Despiro doors. This multipurpose solution guarantees great aesthetics and durability. The two-component central gasket provides excellent air sealing and thermal insulation of the space between the sash and frame, which is another advantage of this solution.

Application:

- thermal strip system, possibility of using an additional insulator – SI or Aero version,
- installation of a concealed sash is possible
- single-chamber or two-chamber glazing packages available



MB-77 HS



271

frame installation depth
3-rail profile (mm)

77

sash installation
depth (mm)

58,5

max. thickness
of glazing (mm)



Exclusive lift and slide doors with large dimensions and the best thermal insulation parameters. An innovative solution, whose design allows sashes to be combined at a 90-degree angle without the need to mount a fixed mullion at the corner.



Glazed lift and slide doors enlarge the interior visually and fill it with natural light. Thanks to the appropriate construction of the sections, the doors based on the MB-77 HS system provide full thermal comfort and convenience.

Application:

- thermal strip system, large sashes available:
up to 3.2 m high and 3.3 m wide,
- structures consisting of up to 6 sashes may be created,
- frames available in two versions – with two and three guide rails,
- a low threshold can be installed.



DESPIRO DOORS

The elegant collection of Despiro doors forms an attractive range for the most demanding of customers, who value modernity not only in the technological aspect, but also in the aesthetic one. A combination of beauty and durability in one element, making it impossible to pass by indifferently.





eko
okna

Despiro doors

Aesthetics and design

The technology for making Despiro aluminium doors achieves a uniform surface finish. The sash has been hidden behind decorative panels. We offer a wide range of panel designs – with glazing, stainless steel applications or decorative milling. The Siegenia Axxent concealed hinges also ensure cohesion and visual harmony.

Sealing and insulation

Using the MB-86 system as the supporting structure creates light, yet rigid, durable aluminium profiles, available in four construction variants (ST, SI, SI+ and AERO) and in three bottom sealing combinations. The doors have very high water and air sealing, as well as excellent thermal and acoustic insulation. It makes a real impact both on the comfort of the interior and the costs of its use.

Individual style

Thanks to the fact that the external door elements are covered with a layer of special lacquers containing epoxy resins, they do not require any additional maintenance. The doors from this line can be based on the threshold or non-threshold system, and thus better suit your needs. The doors can be equipped with fixed, side toplights. This solution is particularly recommended for darker rooms, without access to natural light.





High quality

In producing the Despiro doors, we rely on the MB-86 thermo-insulated aluminium profile system, which is one of the most technologically advanced door systems available. The profile has been adapted to utilise special fillings, flush with the frame surface. The door fillings are based on durable and weather-resistant materials. The external elements are additionally covered with lacquers based on epoxy resins, thanks to which the doors retain their appearance for many years.



Despiro

Cross-section through Despiro doors

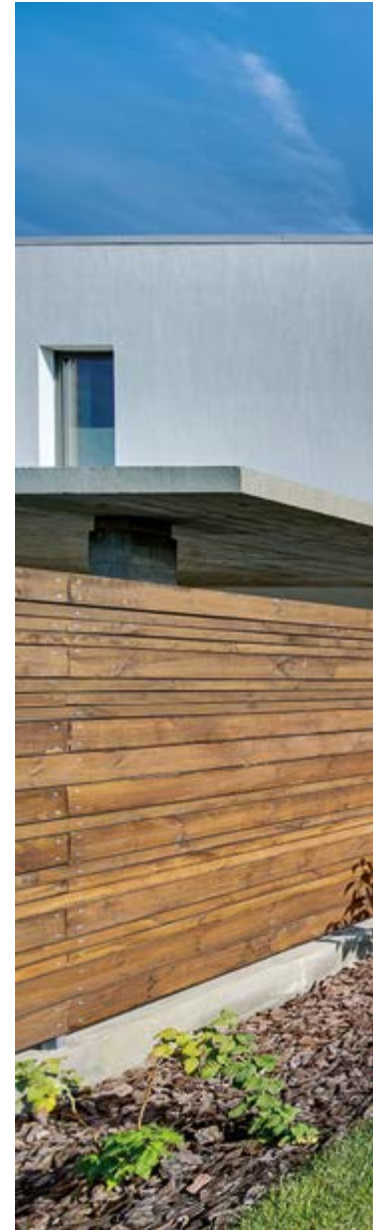

Advantages of Despiro panel doors:

- Panel doors based on the Aluprof MB-86 aluminium system – Aero version,
- Perfectly flat surface, thanks to the special aluminium construction,
- Width 77 mm – flush frame and panel glued to the sash,
- The possibility of constructing large structures: 1.40 m wide / 2.60 m high,
- Hidden Axxent Sigenia hinges, providing the effect of cohesion and visual harmony,
- Possibility to equip with fixed side toplights,
- Standard 2-chamber glazing, $U_g=0.7 \text{ W/m}^2\text{K}$,
- Water resistance class – 6A,
- Durable construction based on aluminium, maintenance-free,
- The possibility of making the doors based on a threshold or non-threshold system,
- Perfectly flat surface, thanks to a special aluminium construction with a double-sided glued panel.



Exclusive

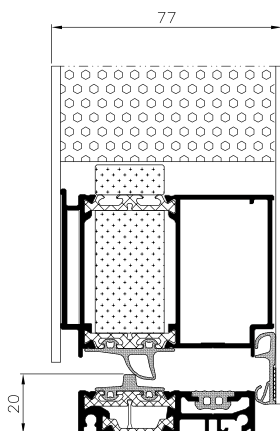

Double-sided flush panels:

- 3-chamber, $U_g=0.7 \text{ W/m}^2\text{K}$,
77 mm thick panel,
- Coefficient $UD=0.61 \text{ W/m}^2\text{K}$,
- Four design variants:
ST, SI, SI+ and Aero.

Despiro

The background of the entire page is a photograph of a wooden window frame. The window is set into a wooden wall and looks out onto a green, grassy area. The wood has a natural, light brown finish with visible grain and knots. The window frame is made of dark wood, and the glass is clear, showing the outdoor scene. The overall lighting is warm and natural.

WOODEN WINDOWS NATURO

Our range includes Naturo 68 mm, Naturo 76 mm, Naturo 92 mm and Naturo 92 Slim systems. Wood is a natural and very durable material. Window frames are created from four layers of wood. Each system is extremely stable and durable. They are also characterized by high thermal insulation parameters.

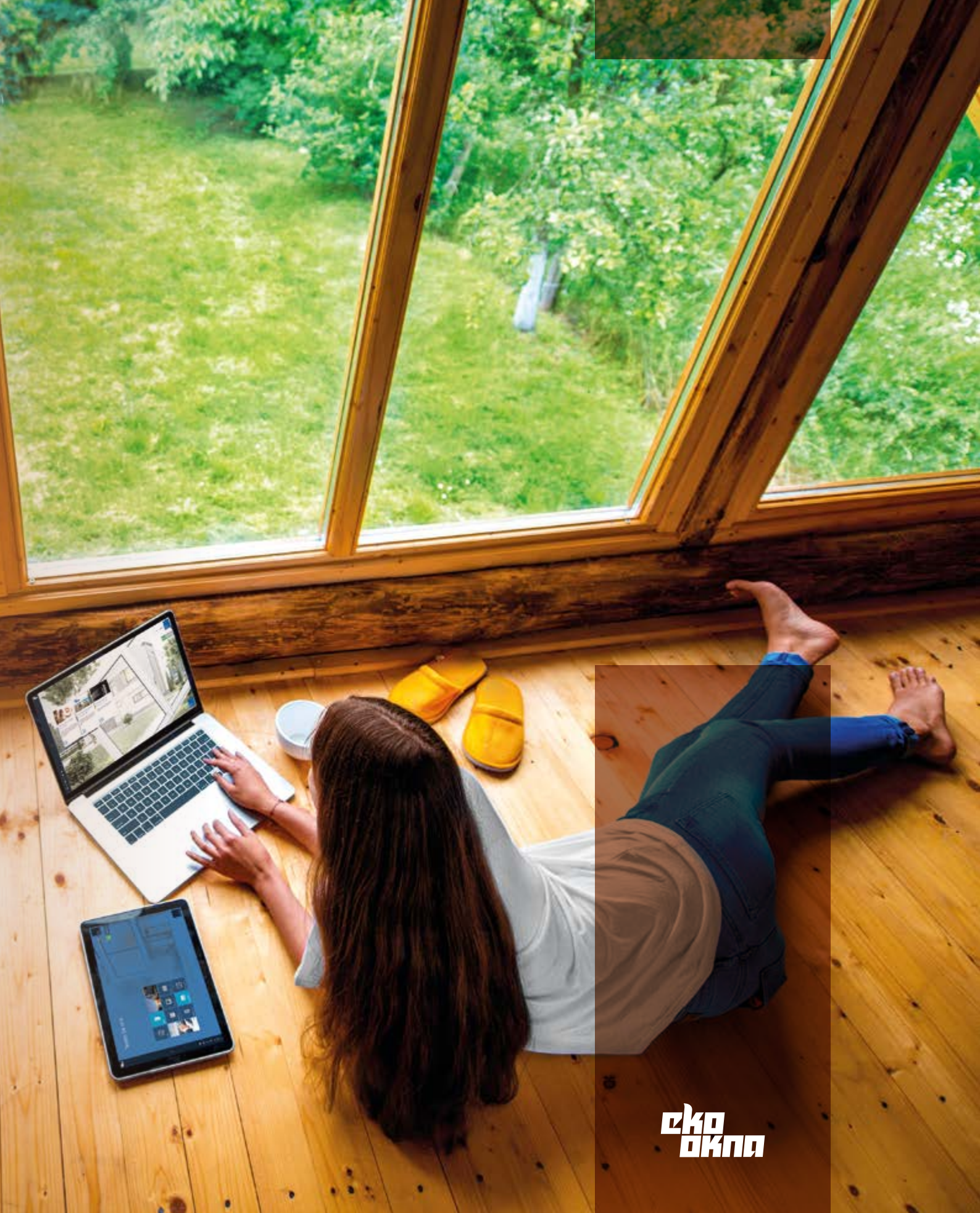

**ЕКО
ОКНА**

Wooden windows

Naturo 68



Naturo 92 Slim

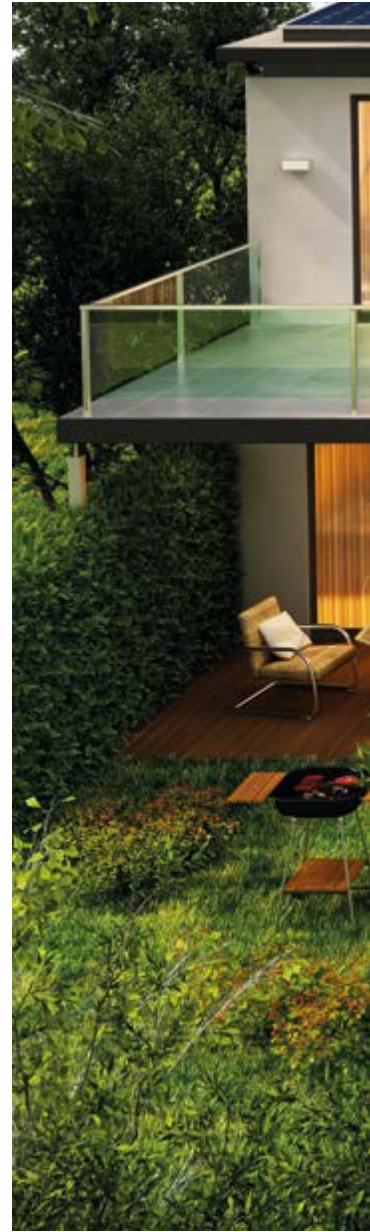



Glued, three-layer wood is subjected to mechanical treatment on a modern computer controlled line, guaranteeing the maintenance of the high parameters and planing accuracy of up to 0.01 mm.

Naturo

Wooden windows





They are produced from many types of wood: Kalzing pine, Kalzing spruce, solid pine, solid spruce, meranti, larch, and oak, properly selected, glued in 3 or 4 layers maintaining an alternating arrangement of the grain. This, in turn, guarantees stability and durability of the structure.

Naturo

PRODUCT LINE ALL IN ONE DESIGN

Developed for those with the most sophisticated tastes and those who pay attention to every, even the smallest detail in designing a house. The „All in one design“ product line enables to save time while selecting joinery, while at the same time guarantees the harmonious appearance of windows, doors, garage doors, and roller allow. It is also a guarantee of total technological compatibility, with the convenience of ordering all joinery from a single source.



eko
okna

All in one design

All in One Design is a guarantee of the harmonious appearance of the joinery. This line includes eight carefully designed groups of windows, doors, gates and roller shutters.



Verona Timeless character



Modena Beauty through simplicity



Foggia In harmony with nature

New definition of style



Livorno Simplicity and elegance

All in one design

You choose the window system, roller shutters, door and gate type, and then leave the whole design process in our hands.



Torino Contrasts for the brave



Firenze Style expressed in detail



Messina Classics with a modern touch

New definition of style



Trieste Colour leading the way

All in one control

While developing the „All in One Control“ product line, we focused on making our joinery functional with smart homes. The technologies we propose aid the home management systems, while ensuring the highest convenience and safety.

In selecting products from the „All in one design“ line, you are assured of complete technological compliance. You choose the products, and we refine all the automation elements with which they are to be equipped. In carrying out our tasks, we rely only on the best solutions from that recognized European producer – Somfy.



Everything in your hands



Control is based on a set of drives, transmitters, and control units, which interact with each other and allow the free control of the roller shutters, gates, doors, alarm and even lighting.

After connecting to such devices as Tahoma Premium or Connexoon, you can operate them using any device with access to Wi-Fi, as well as an IOS or Android operating system, such as a tablet, smartphone, smartwatch or laptop.

SAFEHOME FENCES

A fence is not only the way to ensure safety and privacy, but above all it is a culmination of our investment in building a house. These are end-to-end, high-quality solutions, complete with a range of fence span products, gates and wickets. The SAFE HOME line is available in over ten unique and precision-made designs.





еко
окна

SAFEHOME *Standard*



EK.10.101



EK.10.102



EK.10.103



EK.10.104





Standard, Elegance and Prestige – we offer fences made in three styles, thanks to which you can easily choose one that perfectly matches the surroundings. The fences can be lacquered based on any of the colour palettes we offer. An additional advantage is the possibility of creating an individual project, adapted to the surroundings.

SAFEHOME

SAFEHOME *Elegance*

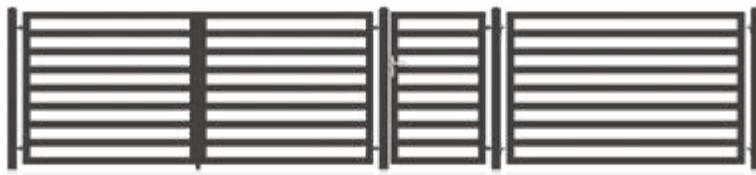

EK.10.105

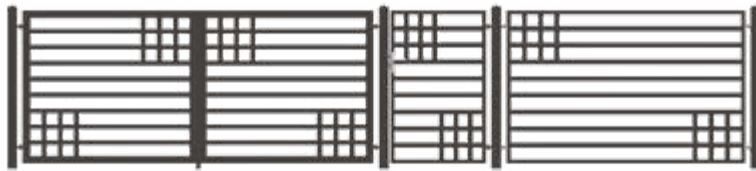

EK.10.106

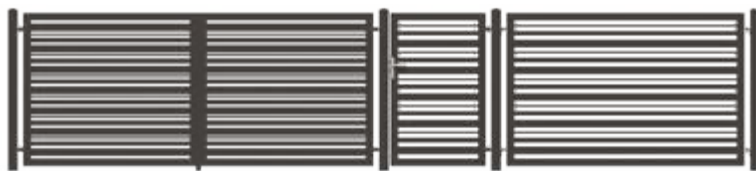
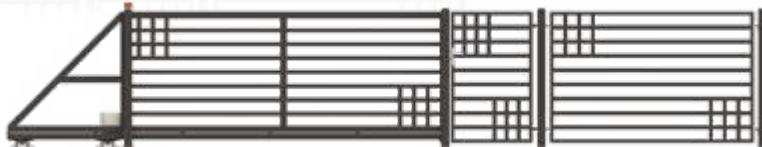

EK.10.107

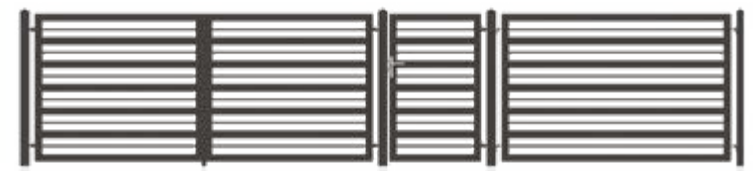
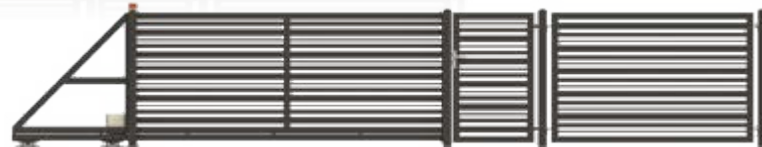

EK.10.108

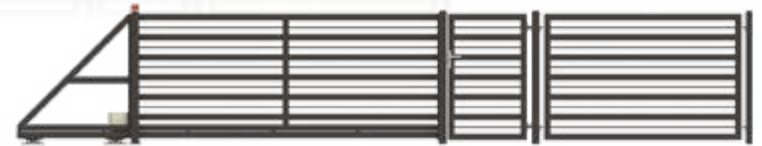



Regardless of the appearance and shape of the spans, all fences include one thing – a solid construction.

All of the elements are made of galvanized steel, providing excellent corrosion protection. The deadline for completing an order, which is only 6 weeks for fences from the Standard line, also remains unchanged.

SAFEHOME

SAFEHOME *Prestige*

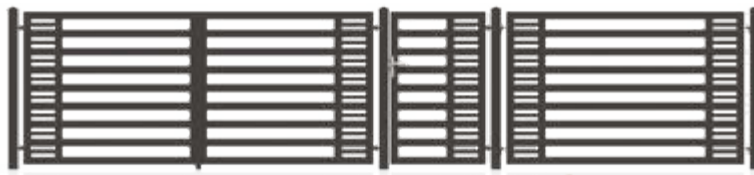

EK.10.109

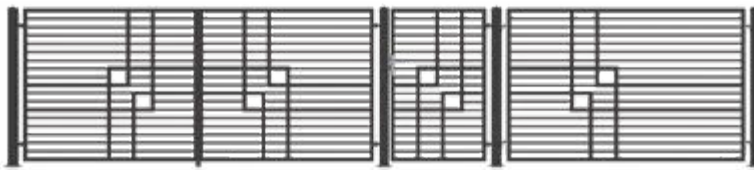

EK.10.110

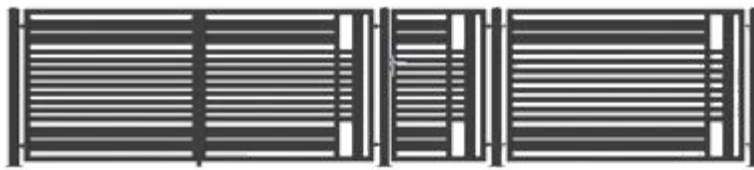

EK.10.111

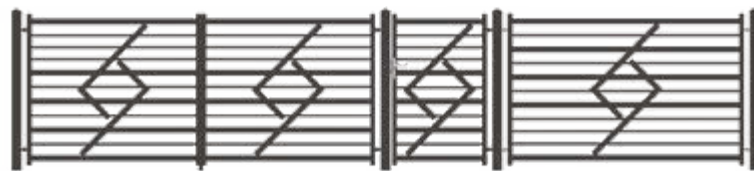
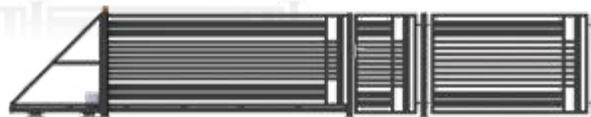

EK.10.112

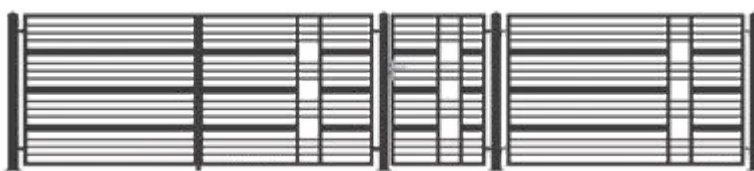
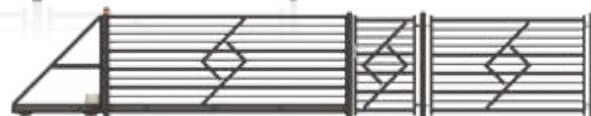

EK.10.113





We produce Safe Home fences based on the highest quality materials and the latest technologies. Each element is protected with a layer of zinc, which provides excellent corrosion protection. In addition, the steel elements are powder painted in the selected colour. All this is confirmed by a 5-year warranty, which gives you not only the certainty of perfect anti-corrosion protection, but also high-quality welds.

SAFEHOME

COOPERATION WITH BENEFITS

We are one of the leading European manufacturers of windows and doors. We already export 85% of our products to 35 countries around the world. Our products are gaining recognition not only in Europe, but also in the United States, Australia and Africa. A complete range, top-quality products, our own fleet of trucks and a modern production facility make us the fastest developing company in Europe in the market.





**eko
okna**

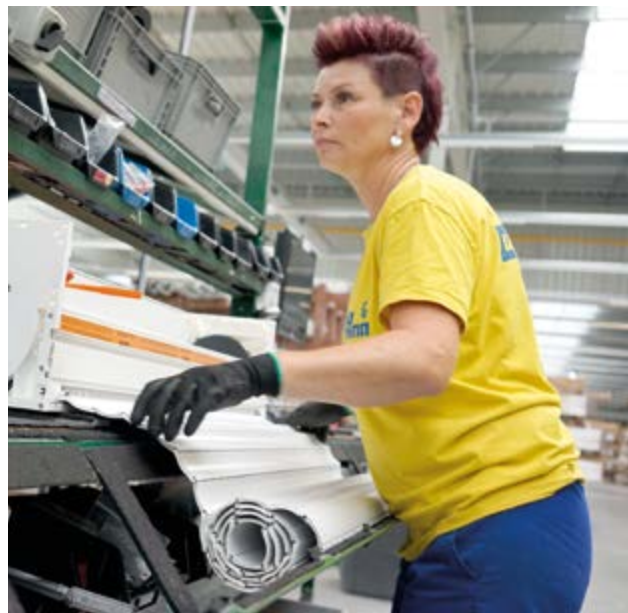
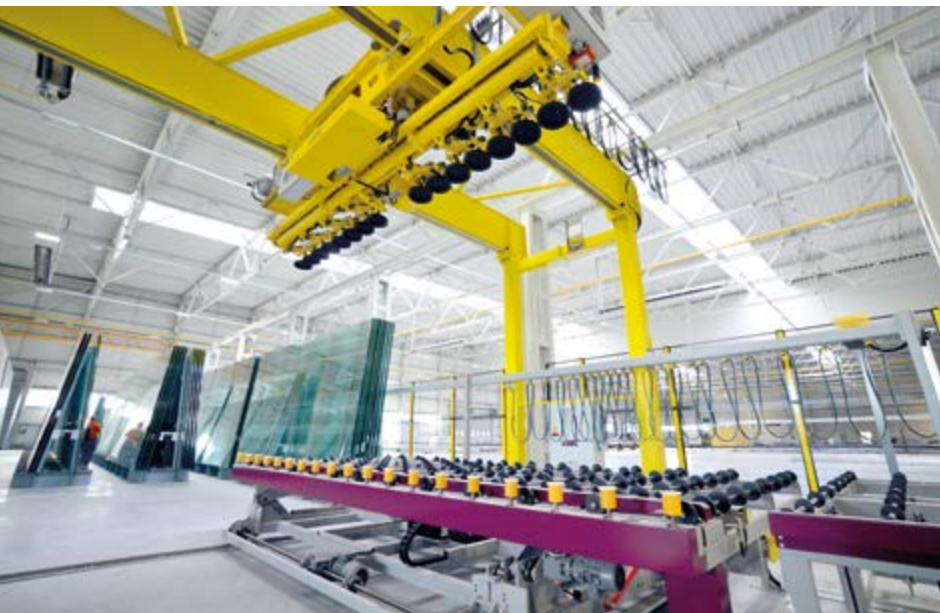

To meet the expectations of all our customers, we have prepared the widest range of doors and windows available in Europe.

We have high quality products that are based on components from the best, branded European suppliers. You receive everything in a single delivery, ready to complete the construction project.

In the interests of the timely delivery of your orders, we have created a delivery fleet, which consists of 350 trucks. Each is equipped with a forklift for unloading goods at an indicated location. In addition, we enable card payment directly to the driver, upon receipt of the order. The production process is essential, and the use of appropriate technology undoubtedly translates into improved operational parameters. That is why we continuously invest in our manufacturing facilities and improve our production technology. As the first company in the world we have decided to introduce V-Perfect technology into mass production. In this way we are able to offer the highest quality as well as accurately finished PVC products. We are also one of few businesses in Poland to offer windows based on HFL technology.



As a company with many years of experience, we are well-aware of the fact that the development of partnerships and customer loyalty is a never-ending job. This is why our business partners are offered support at every stage of the fulfilment. We offer technical advice and regional account manager services, fixed delivery dates and individual consultations. We have a mobile service operating throughout the European Union.



Our advantages

- many years of experience in the window and door joinery industry
- a wide range of windows and doors based on PVC, wood and aluminium
- the fastest delivery dates – typical pvc windows ready in 7 days
- one of the most modern manufacturing facilities in Europe
- high quality products, partnership with renowned suppliers
- our own fleet of trucks equipped with forklifts
- an effective mobile service operating throughout the European Union
- and an extensive, transparent sales network



We work with many European brands:



The logo for EKO OKNA, featuring the word "EKO" in a blue, stylized font above the word "OKNA" in a bold, blue, sans-serif font. The background of the entire page is a light gray collage of architectural elements like window frames and doors, overlaid with a word cloud of terms such as "ALUMINIUM", "PVC", "DESIGN", "INNOVATION", "TECHNOLOGY", "WOODEN", "GARAGE GATE", "SHADES", "MODERN", "TO", "WITH", "THE", "VIEW", "DOOR", "SHADES", "DESIGN", "TECHNOLOGY", "INNOVATION", "MODERN", "PVC", "WINDOWS", "GARAGE GATE", "WOODEN", "MOSQUITO NET", "QUALITY", "PVC", "WINDOWS", "MODERN", "DESIGN", "DOOR", "ALUMINIUM", "1998HST", "WOODEN", "GARAGE GATE", "PVC", "DESIGN", "DOOR", "WITH", "THE", "VIEW", "TO", "PVC", "1998HST", "DESIGN", "THE", "PVC", "1998HST".

**EKO
OKNA**



1/2019

WindowsFactory
PVC | ALU | WOOD