

BG покривни изходи	ES claraboyas	GR Φεγγίτης	MK izlaz na krov	RO ferestre de acces pe acoperiș	SK výlezové okná
CZ střešní výlezy	FR châssis de toit	HU tetőkibúvó	PL wylazy dachowe	RU околюк	TR çatı çıkış kapağı
DE die ausstiegfenster	GB access rooflight	IT lucernaio de tetto	PT claraboia	SE access ljusinsläpp	

## WVR V8 47×73

## WVR V6 47×73

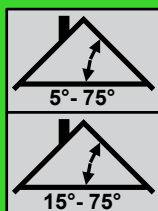
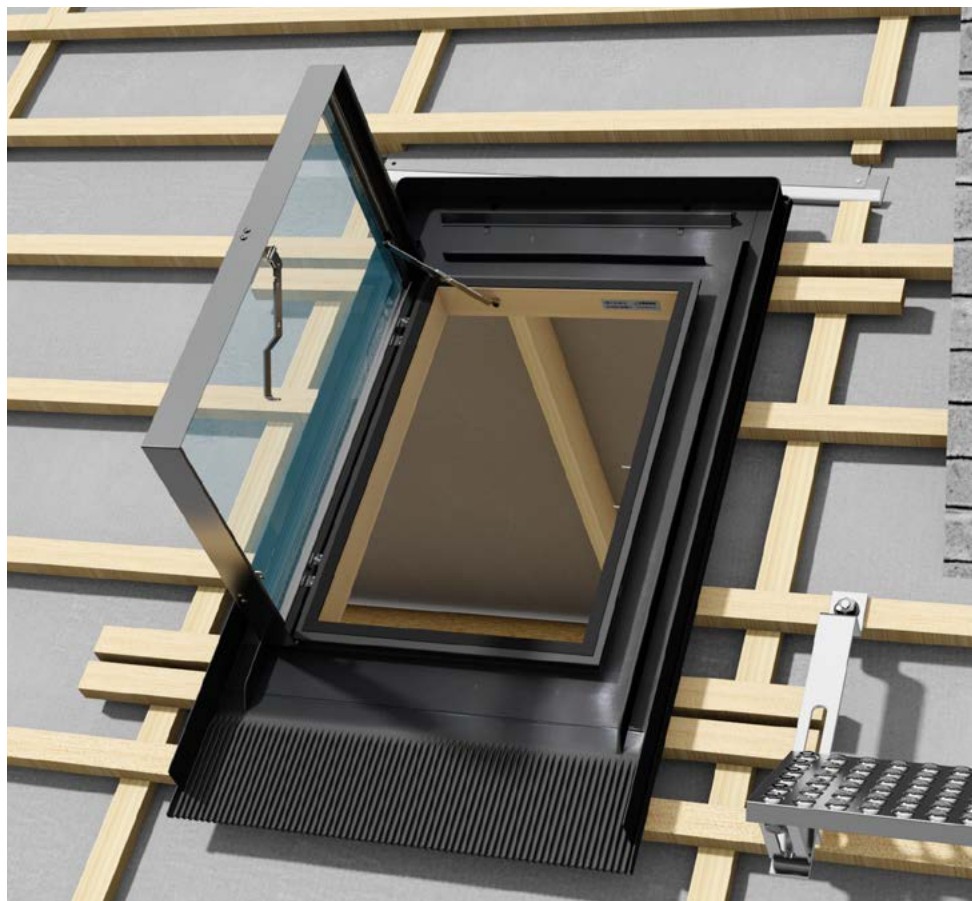

WVR V8 47×73

WVR V6 47×73



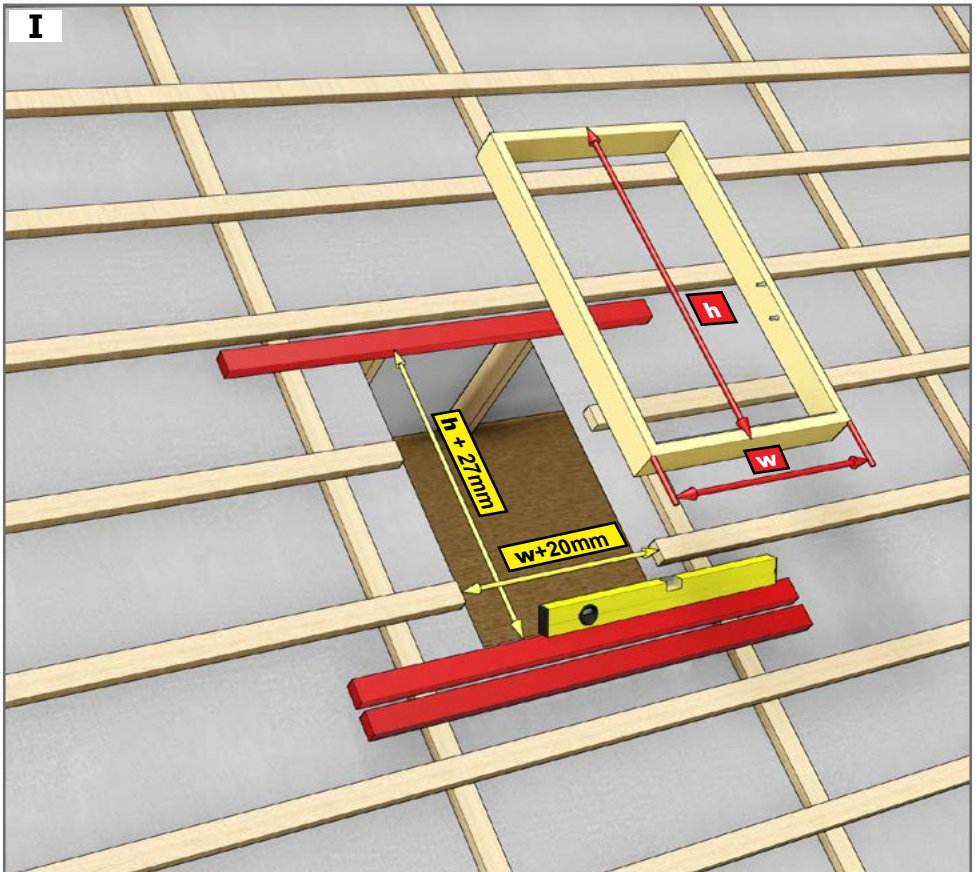
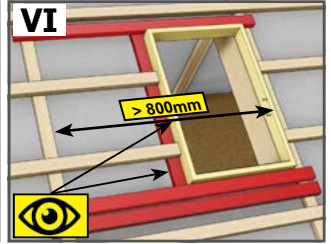
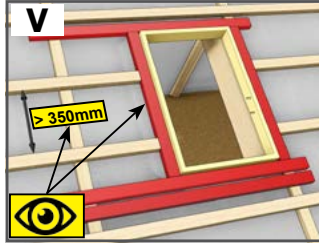
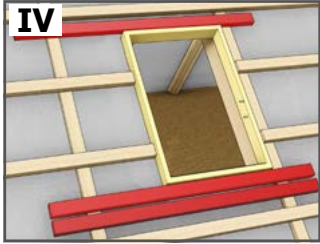
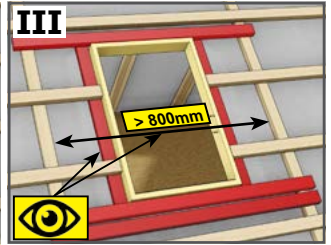
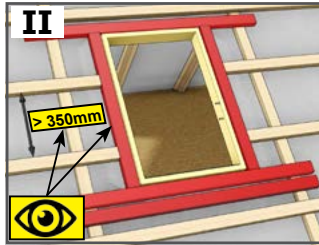
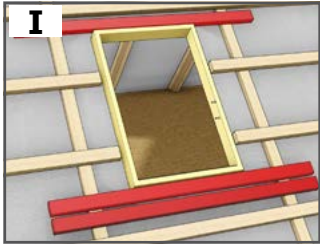



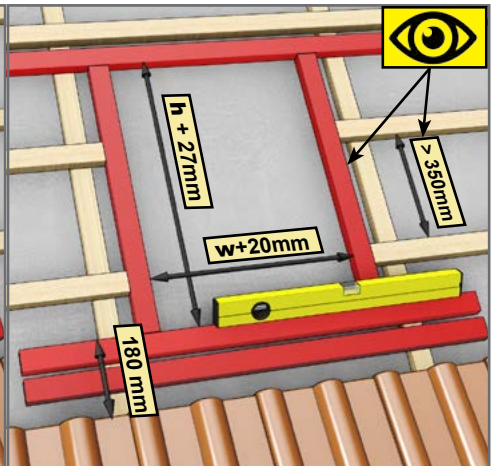
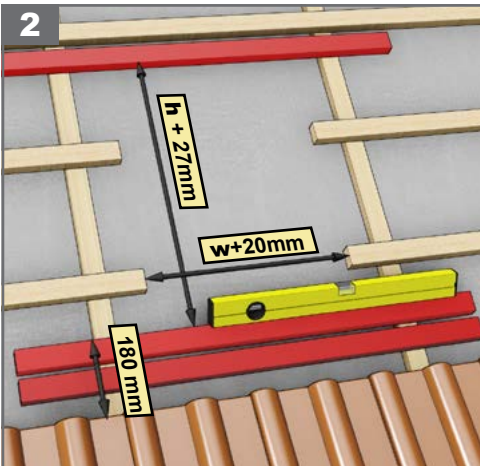
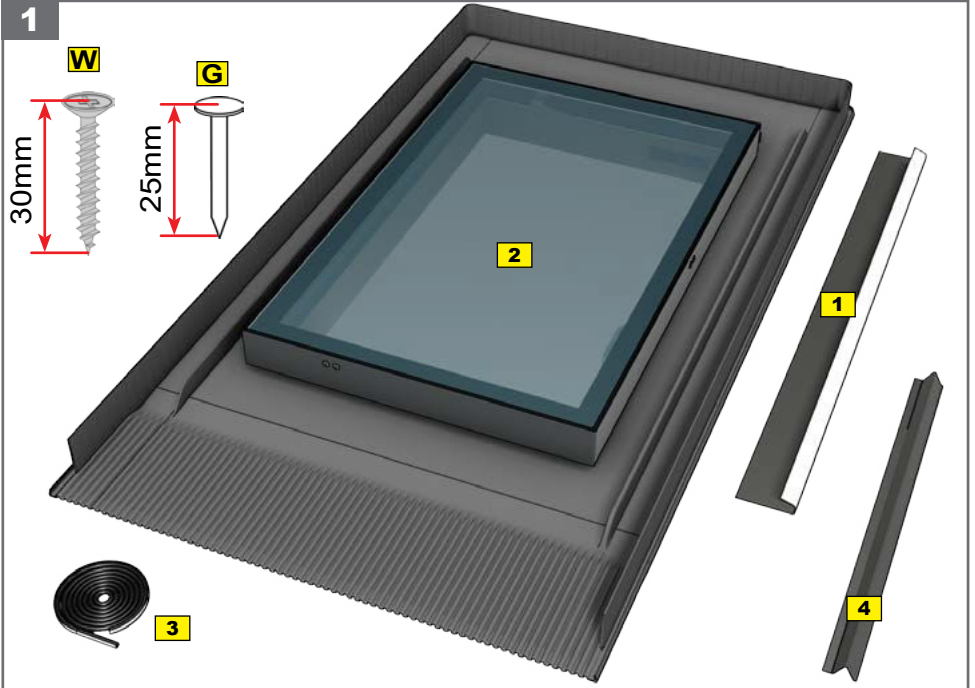
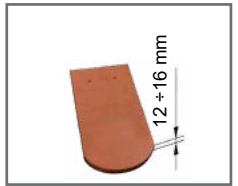
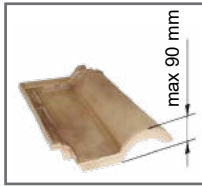
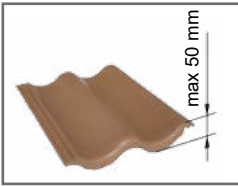

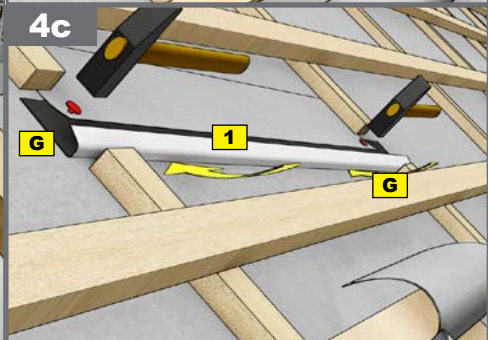
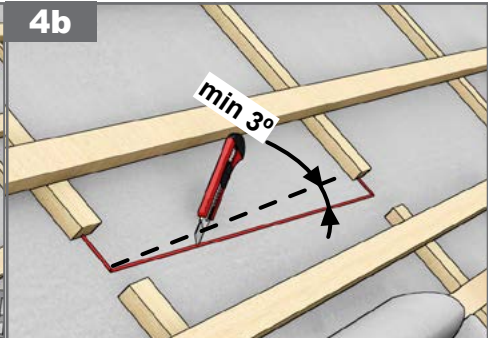
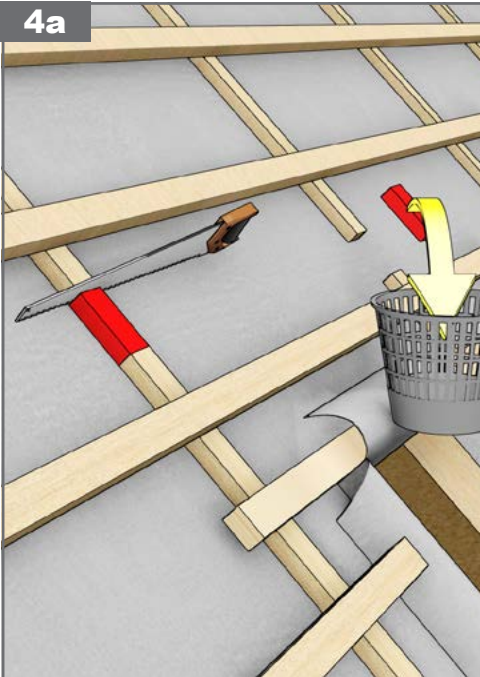
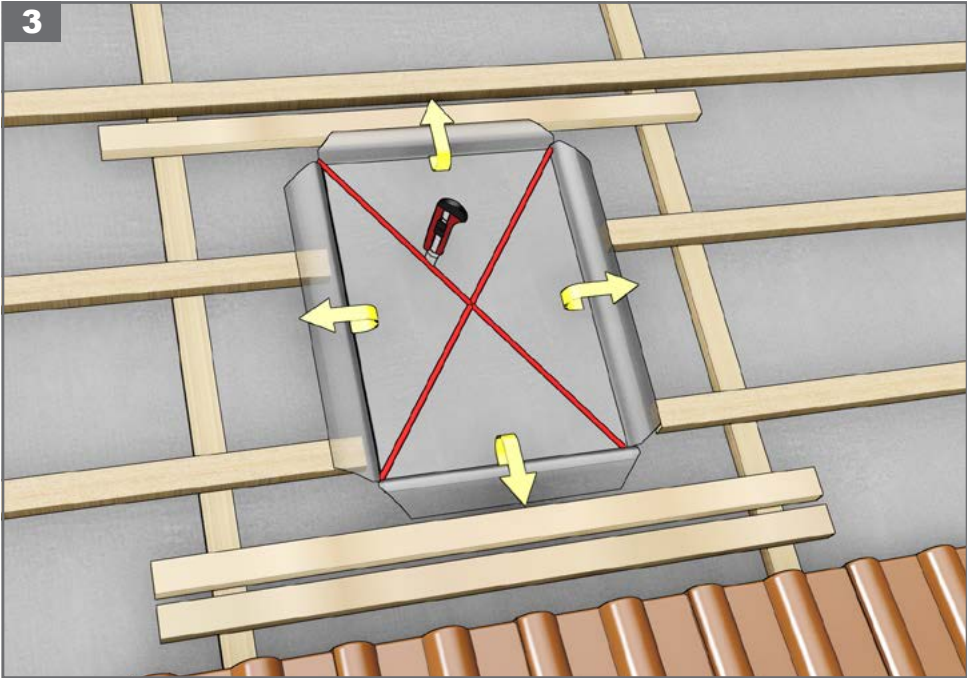

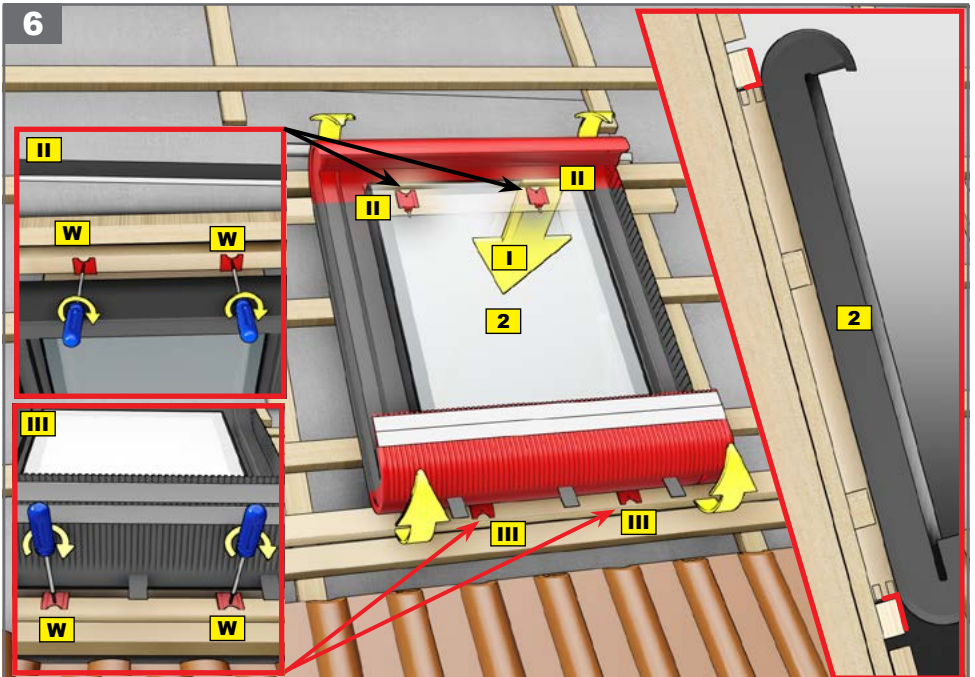
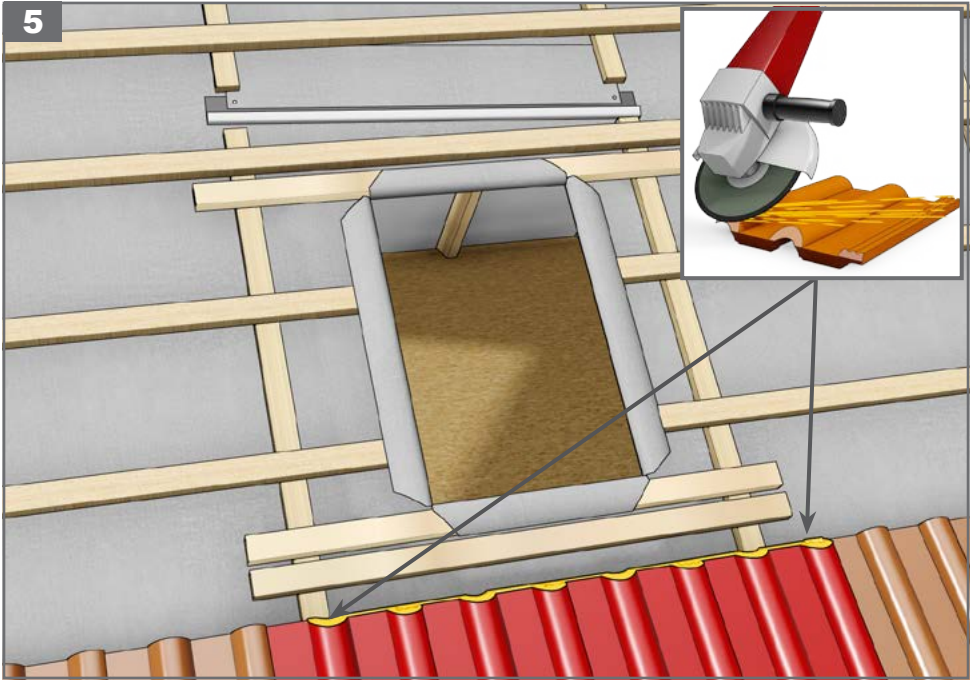

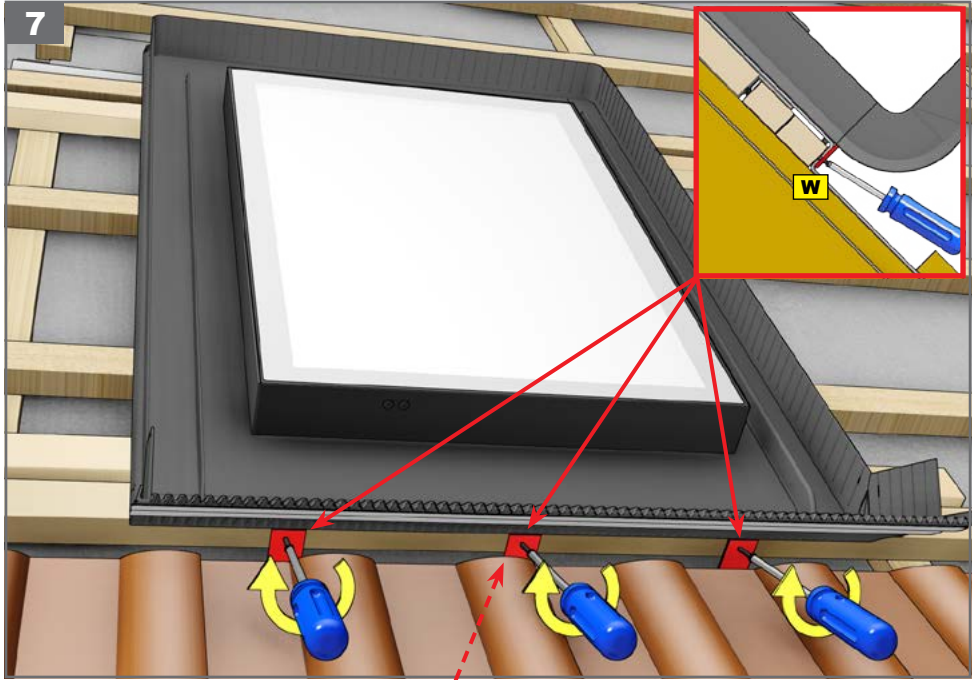

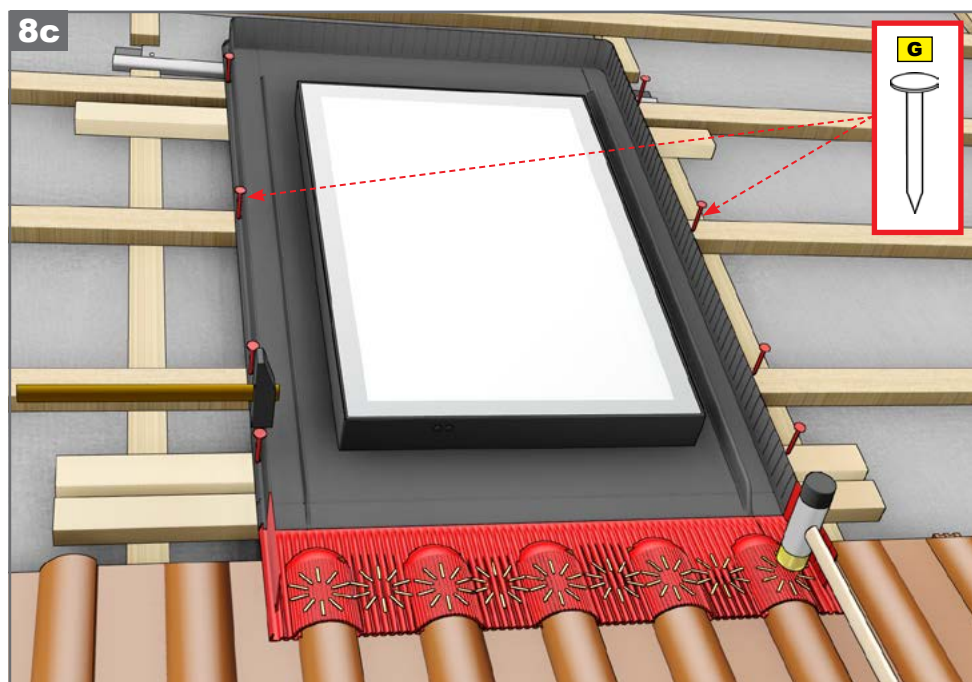



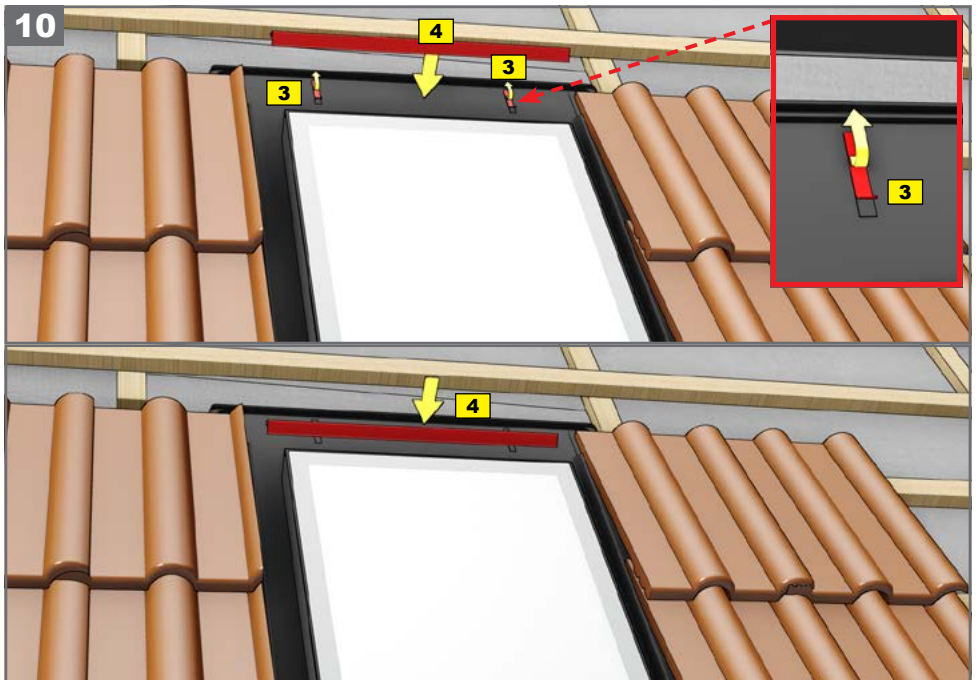
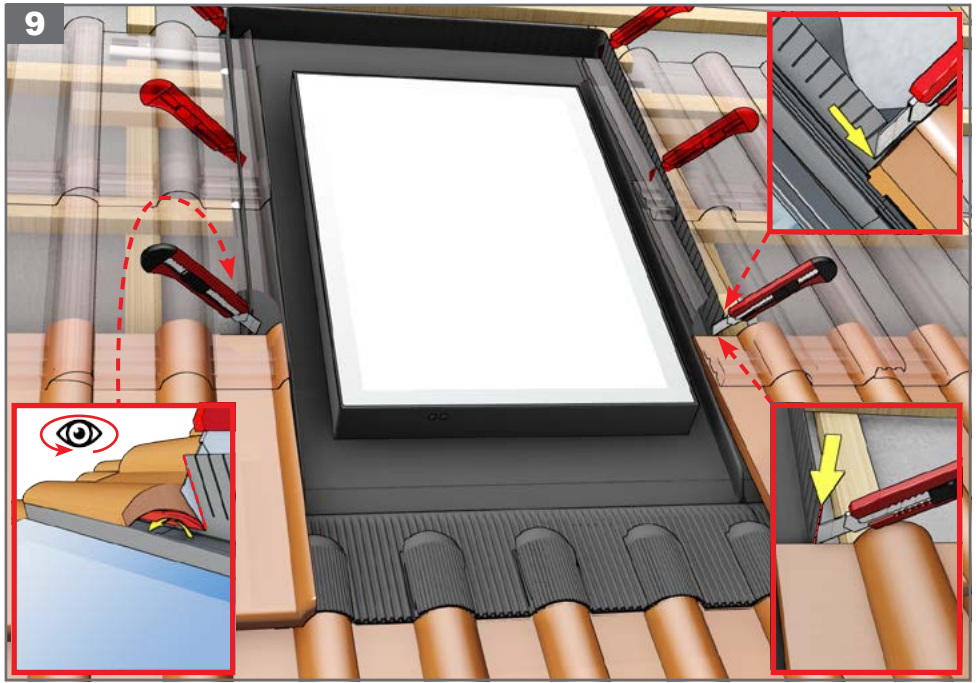

10 ÷ 14

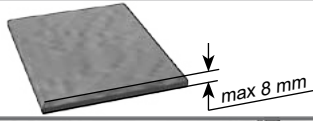

2 ÷ 5

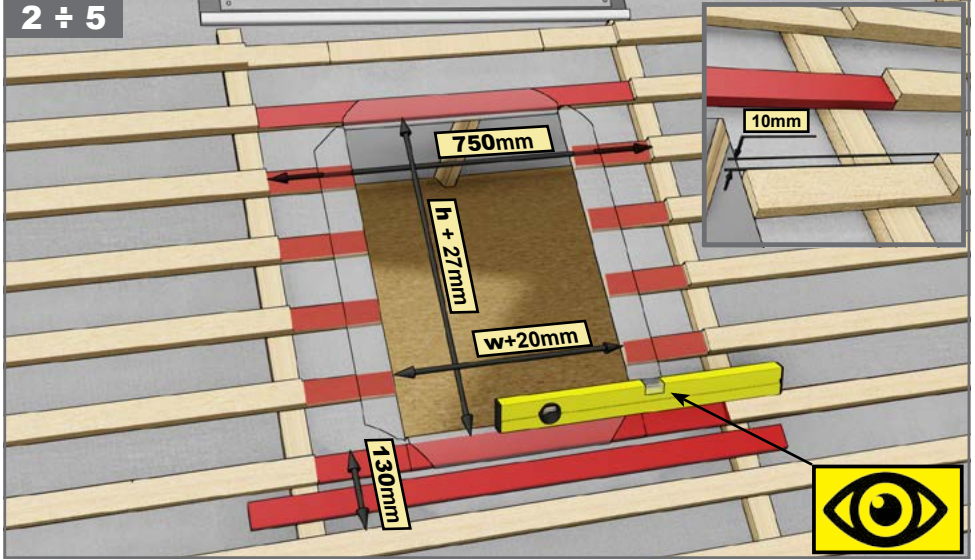

6

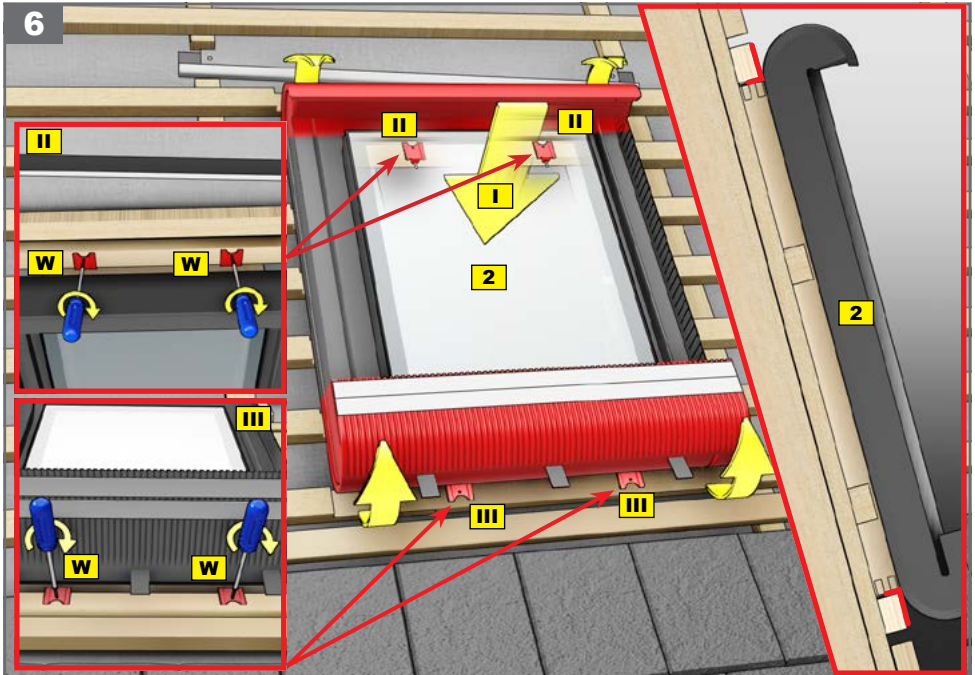

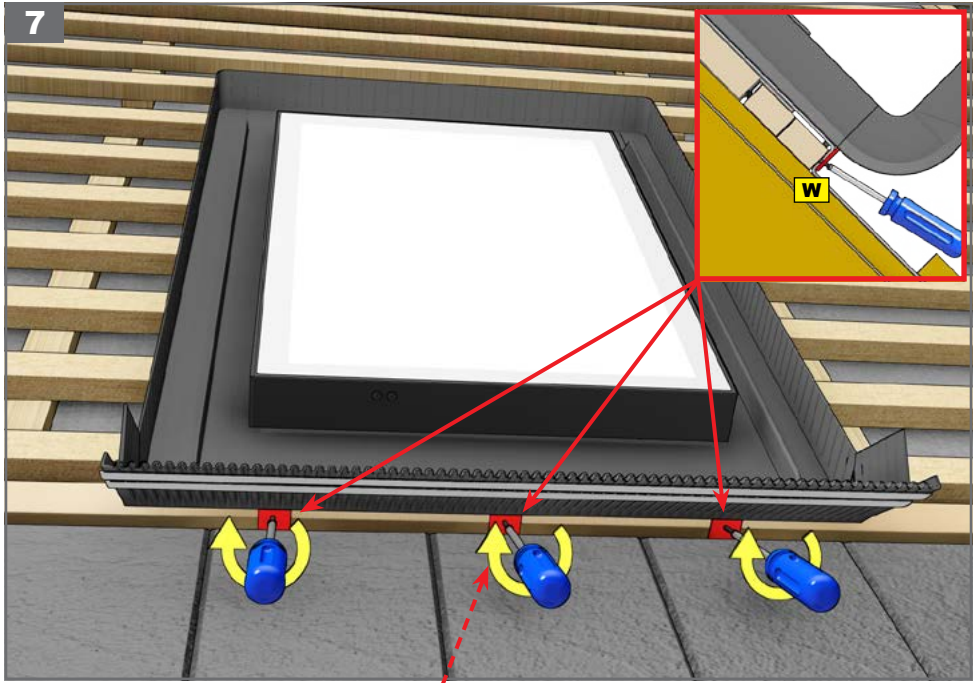

8b

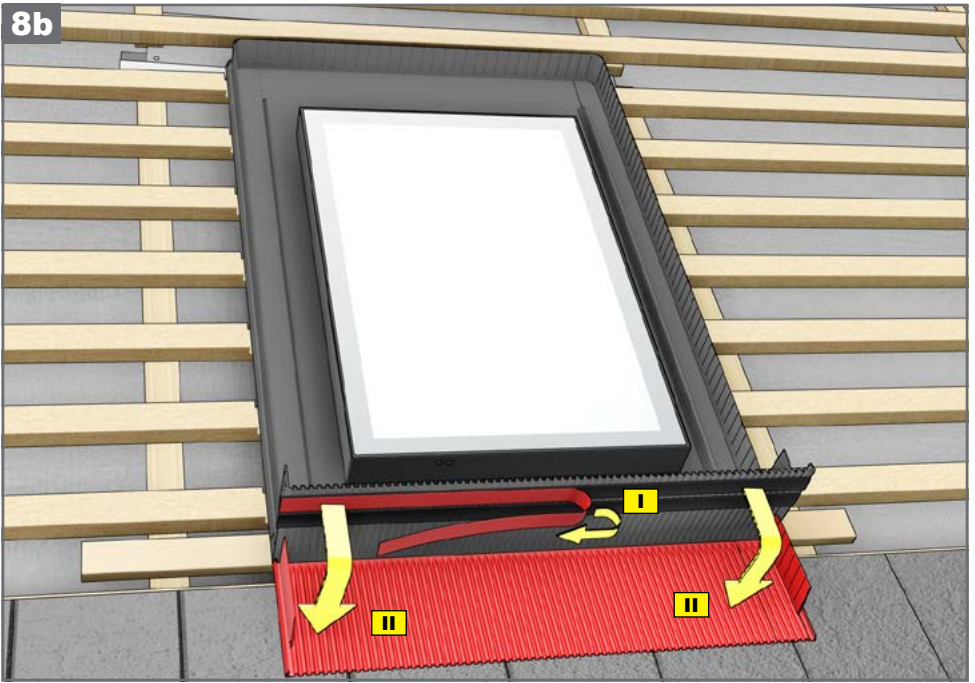

8c

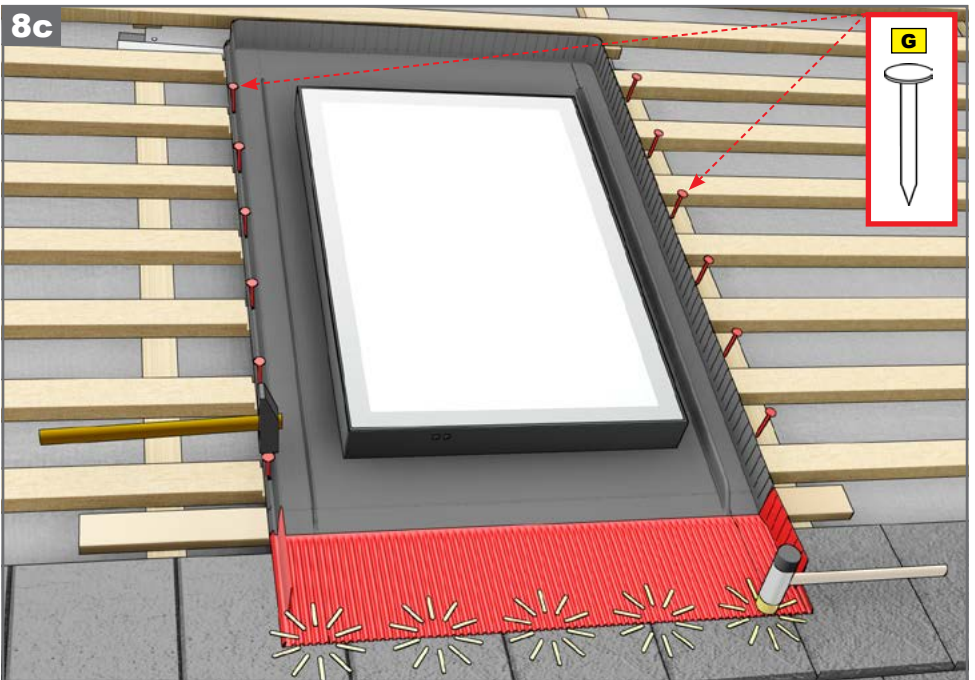

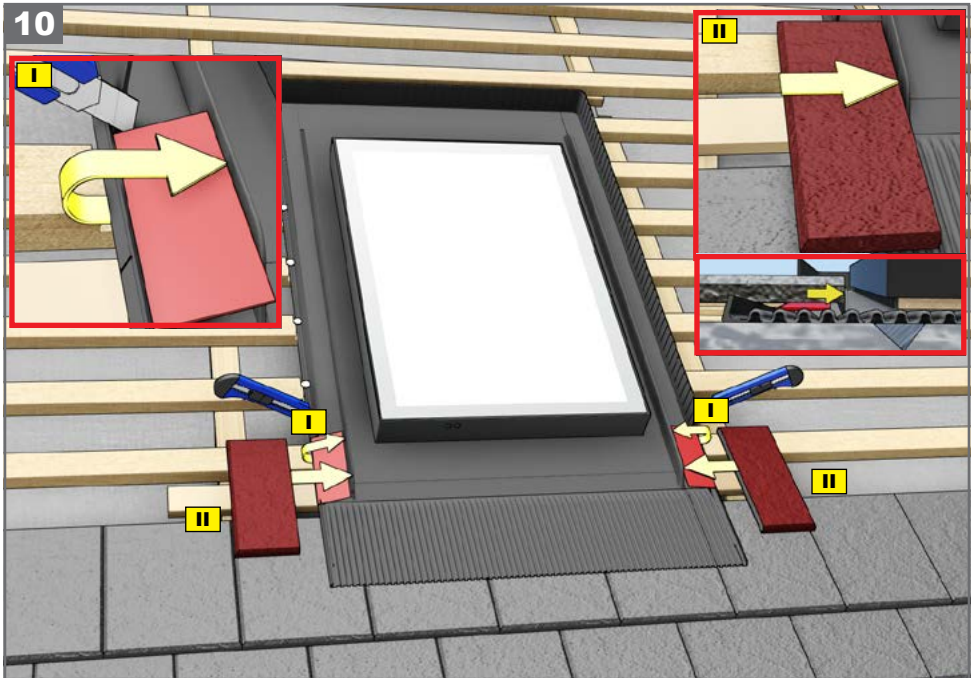
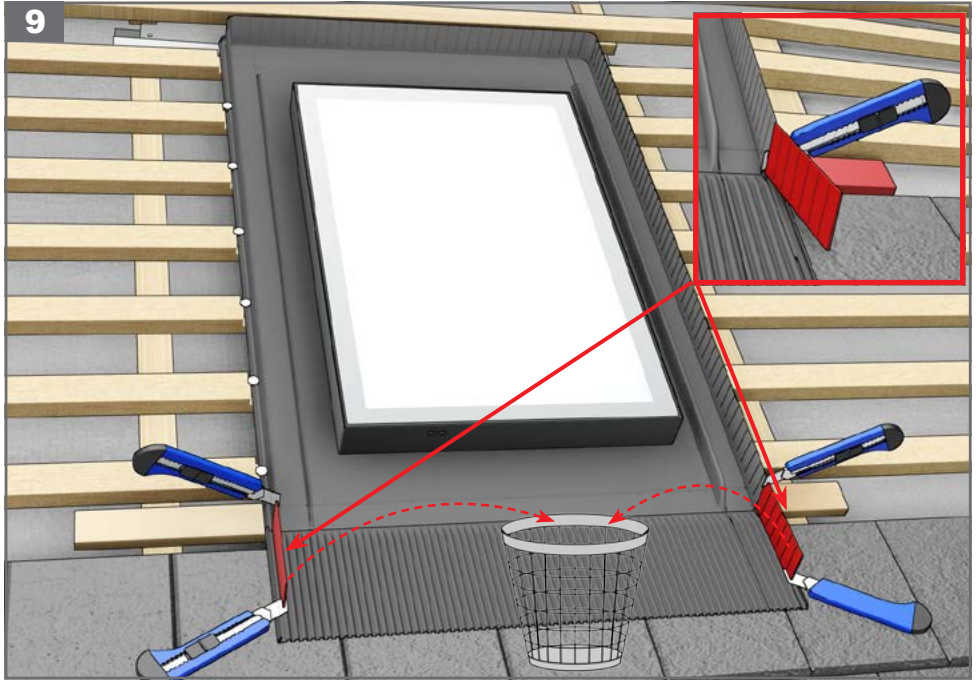

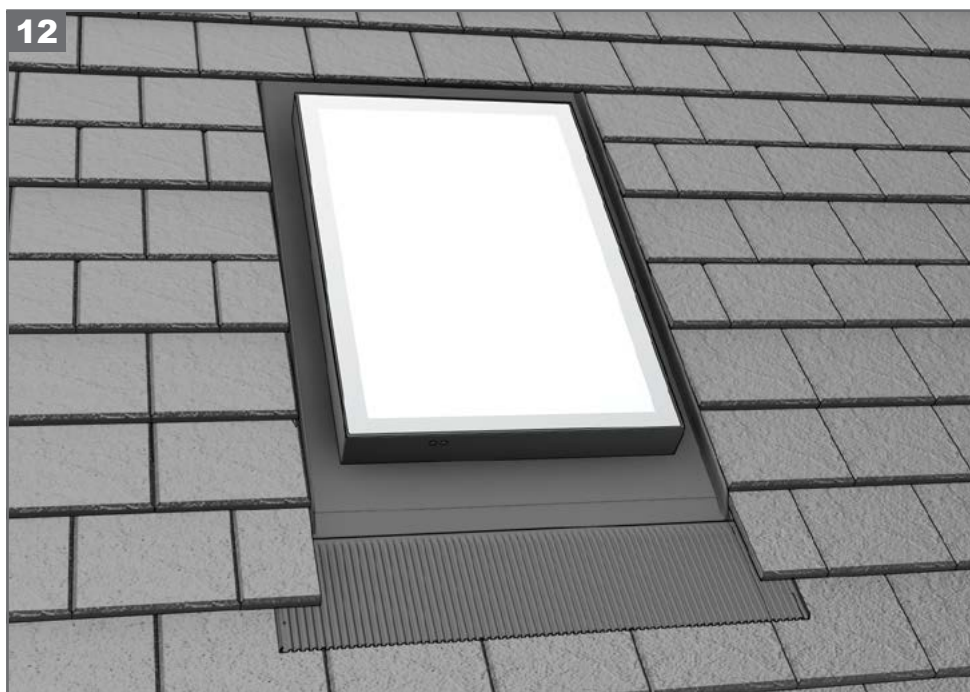
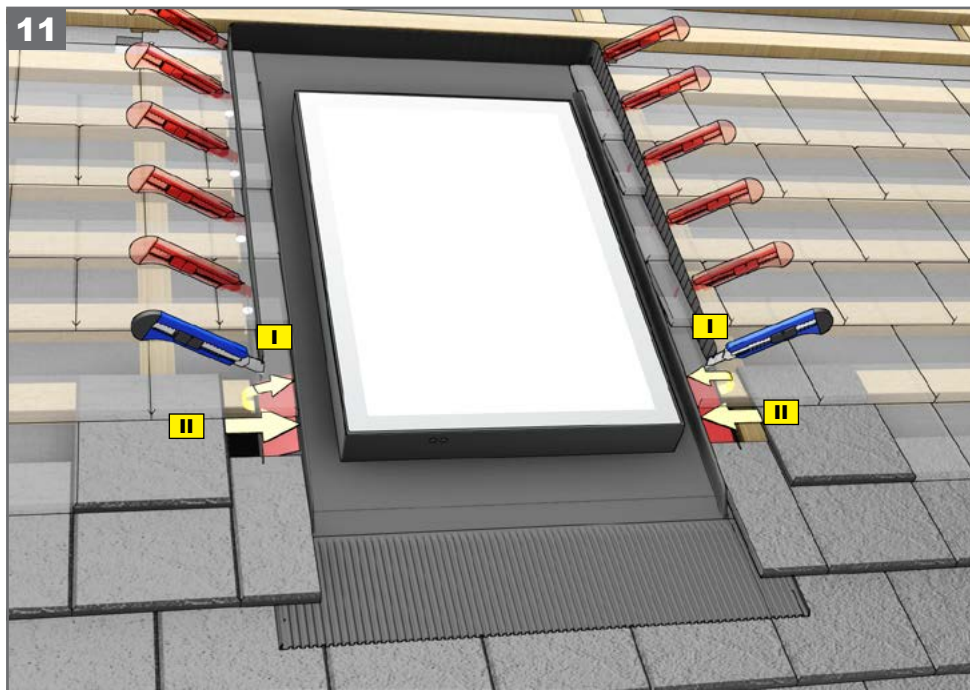

15 ÷ 18



1

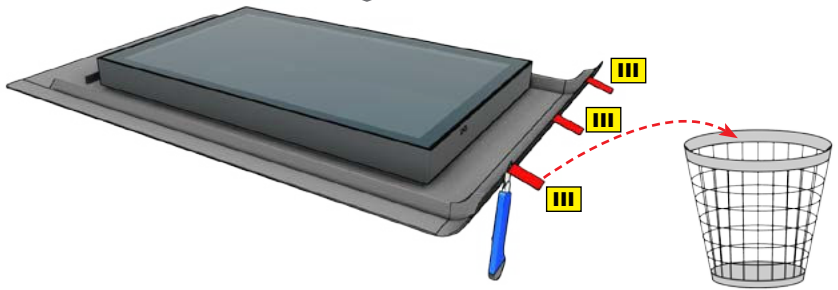
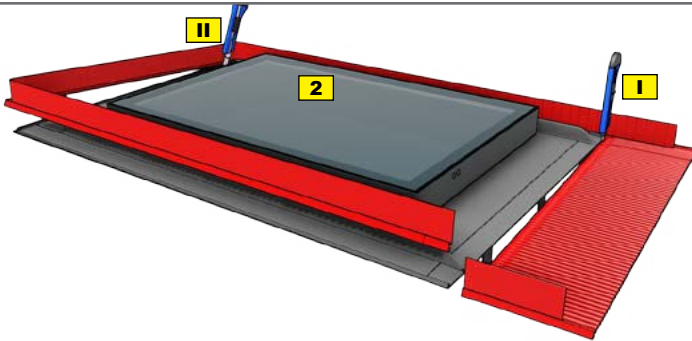

2 ÷ 3

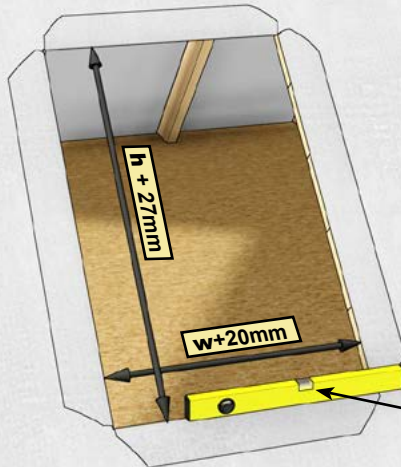

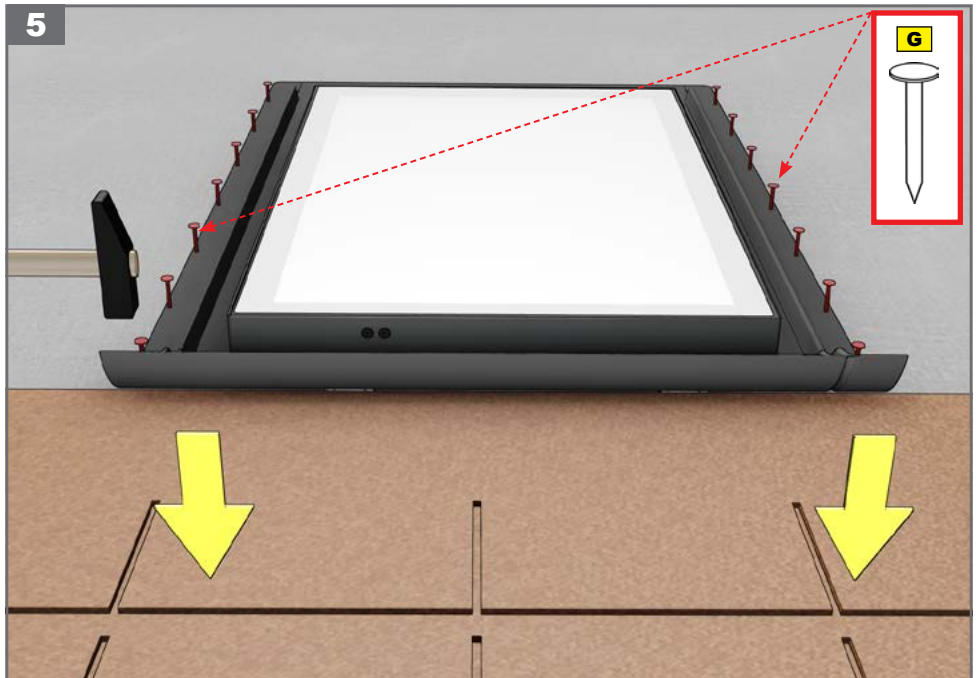
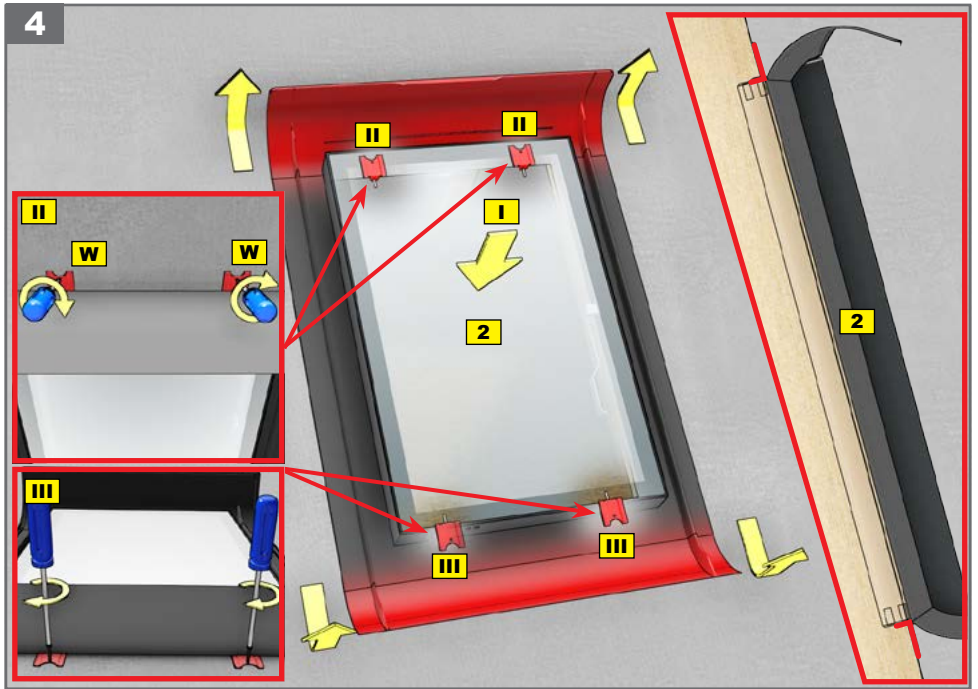



6a

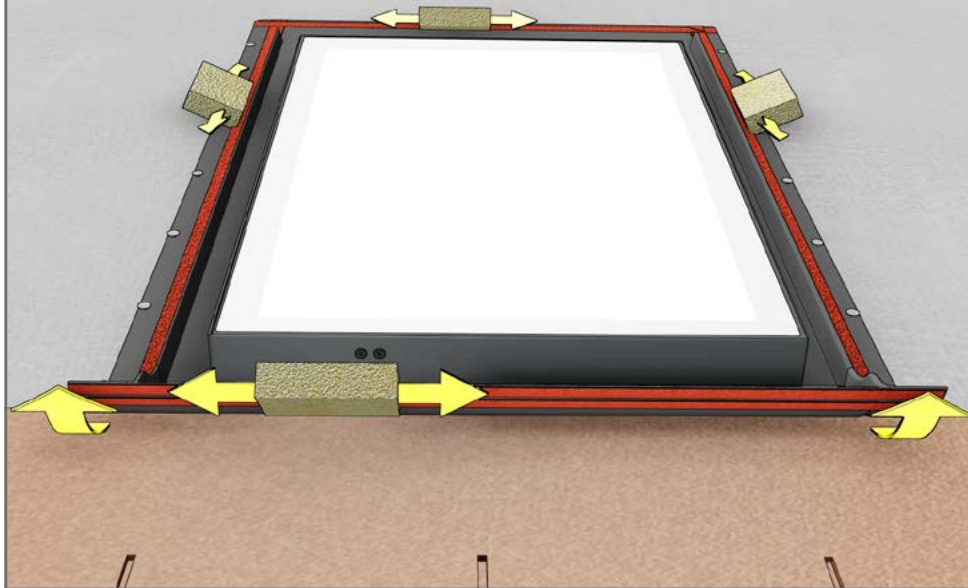

6b

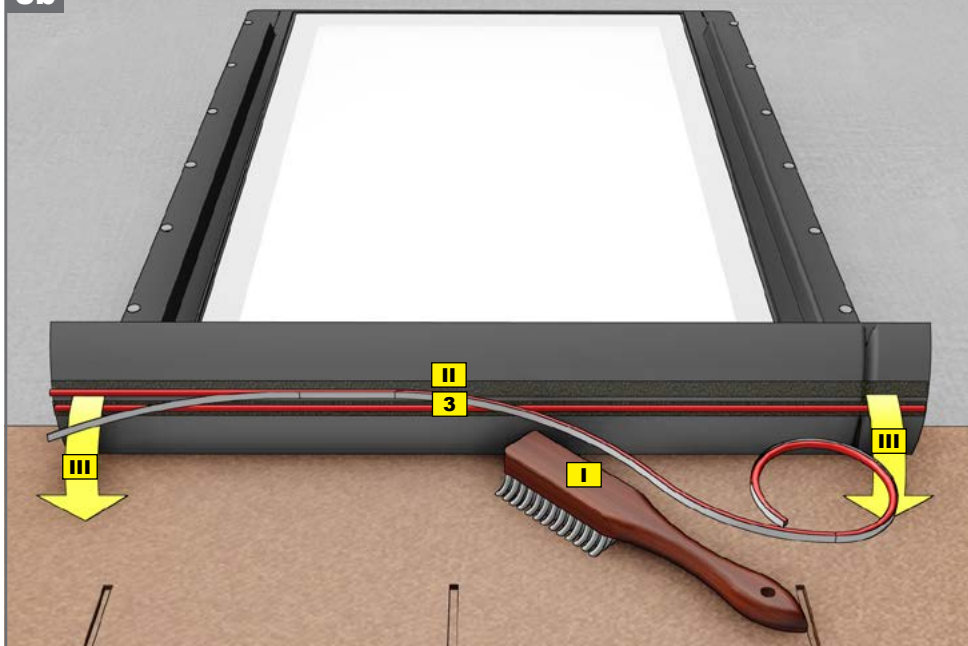

6c

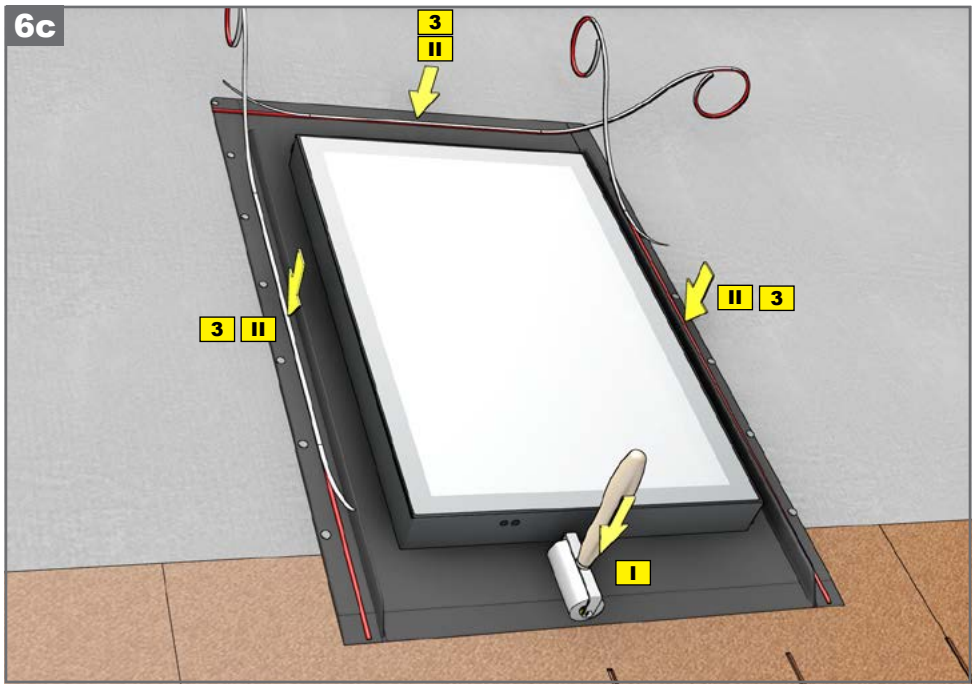

7



19 ÷ 23



1

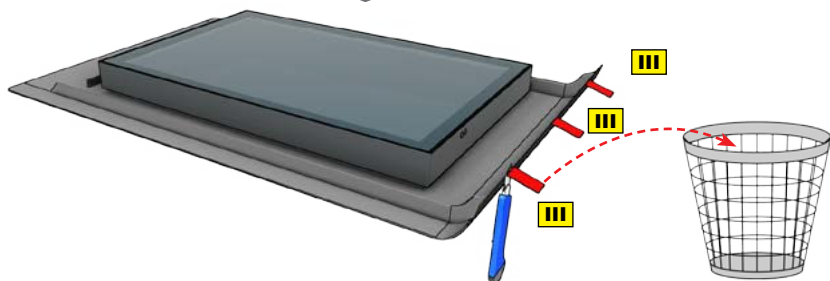
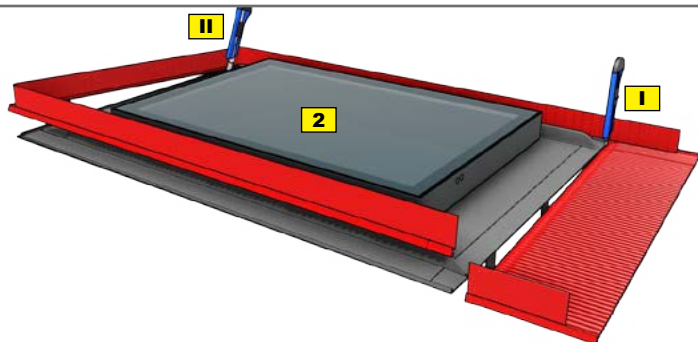

2 ÷ 3

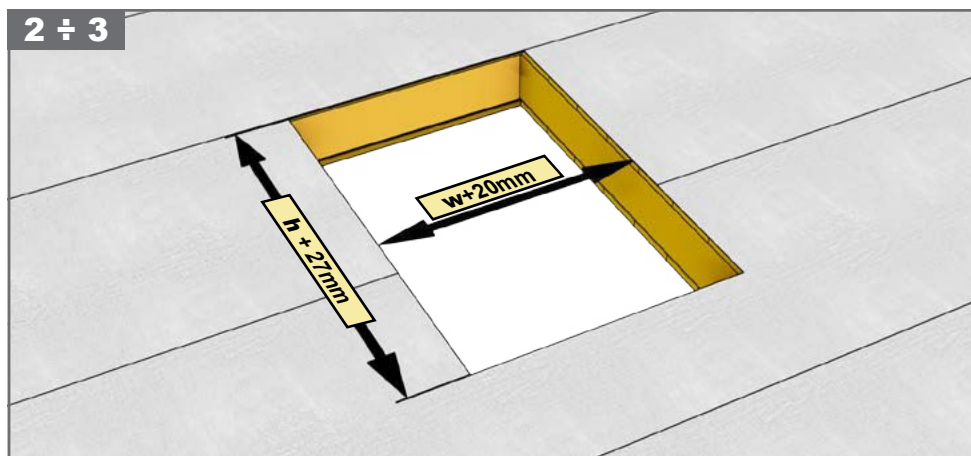

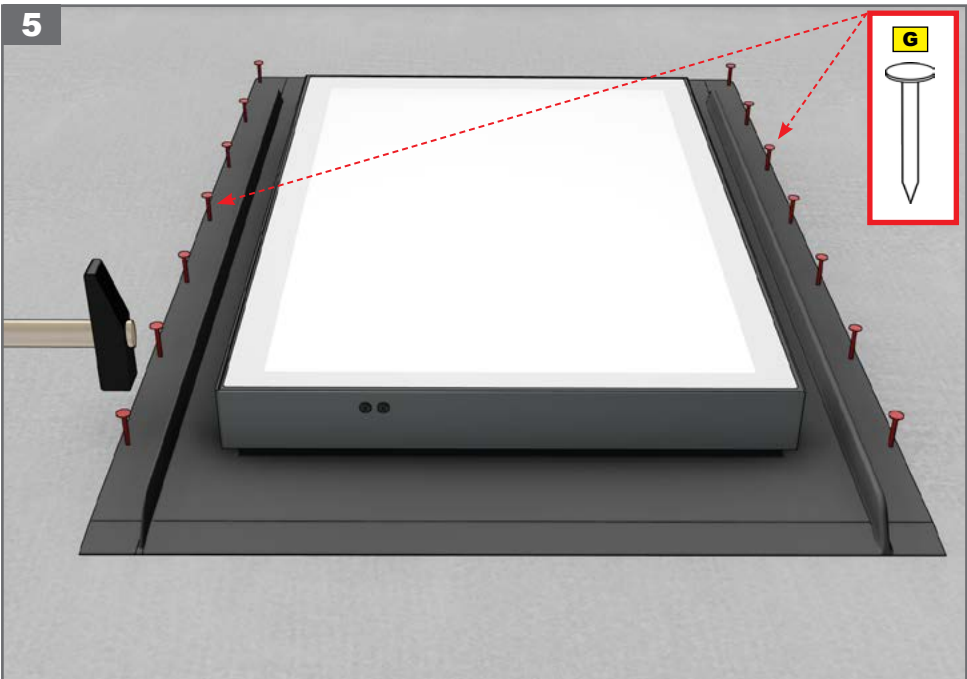
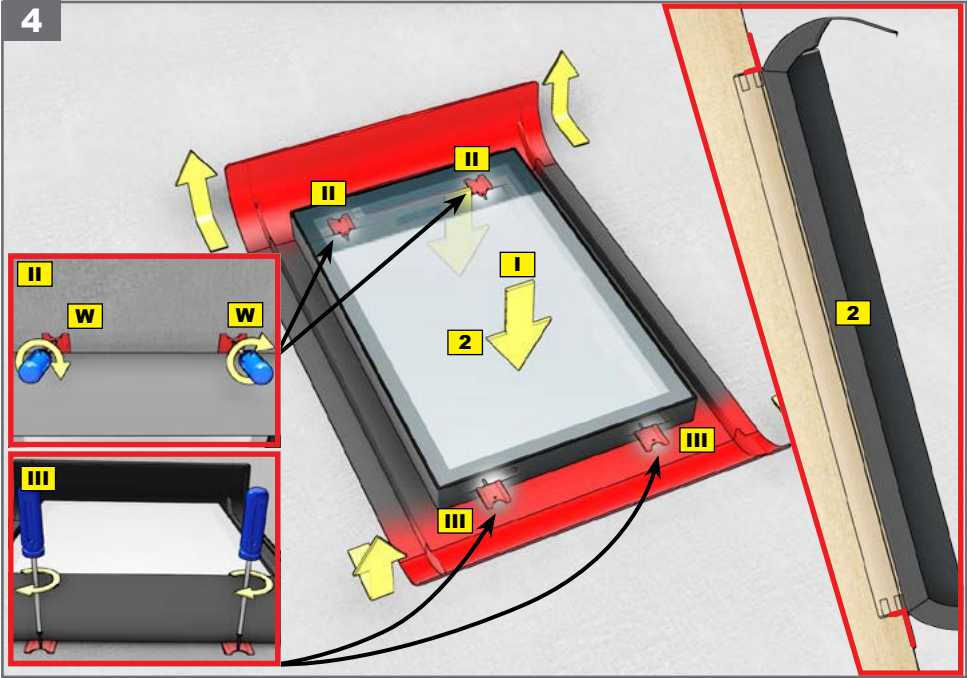

6

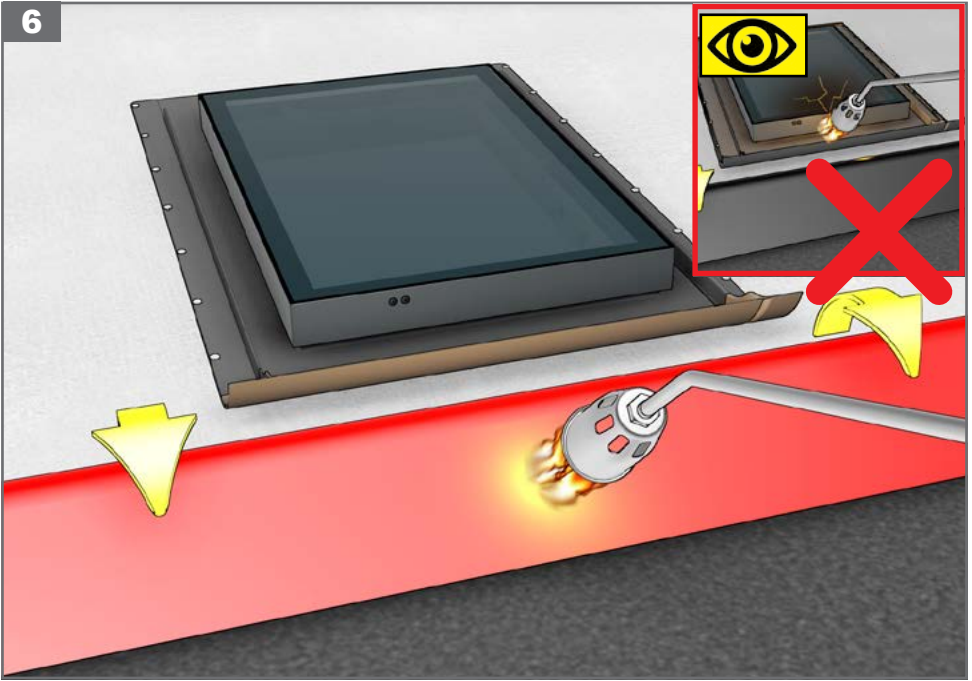

7a

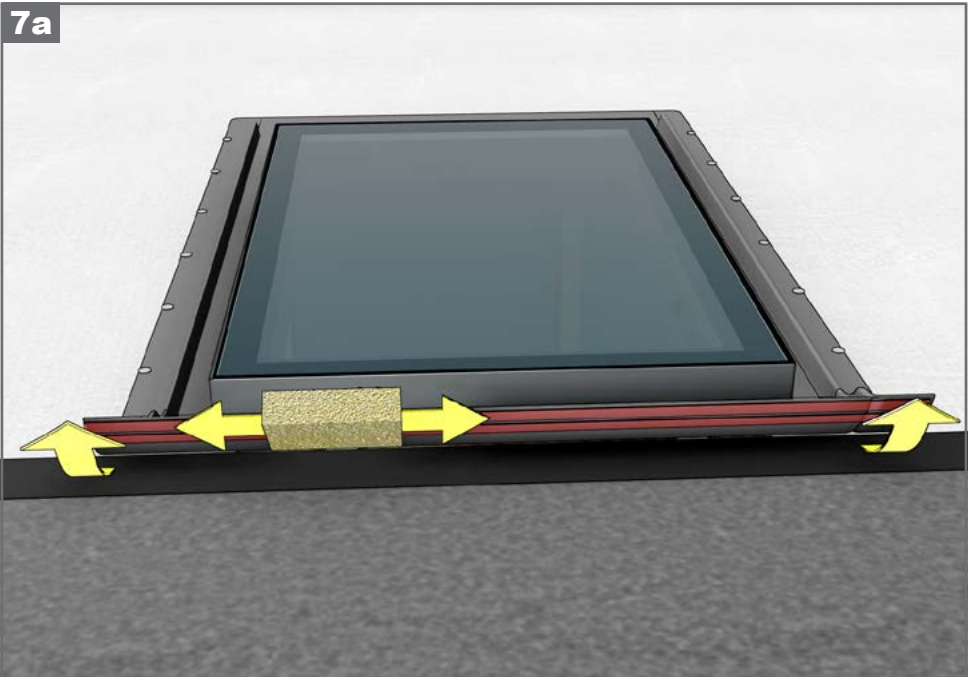

7b

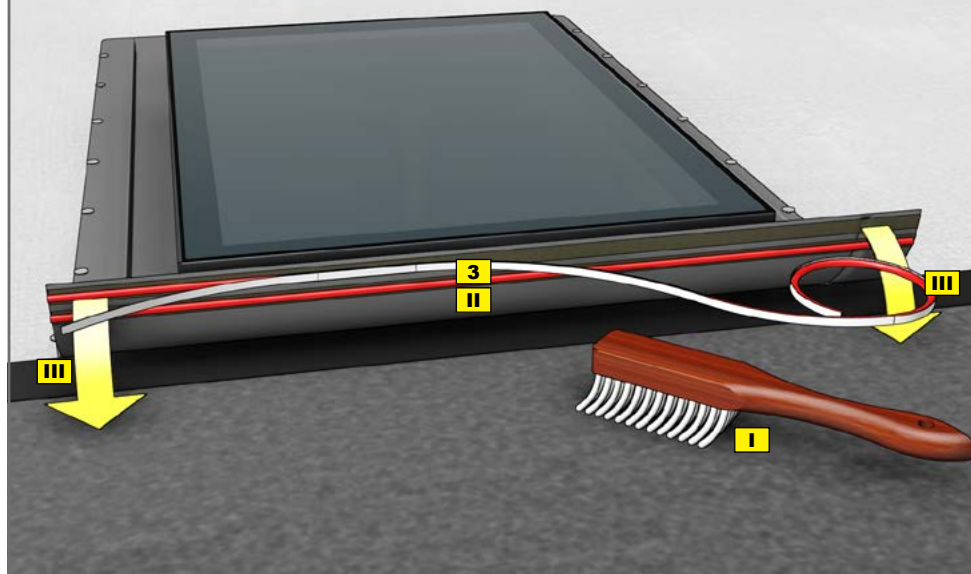

8a

