



ERKADO

doors are our world

INTERIOR DOORS  
CATALOGUE  
2026

Edition I/2026/A  
valid from 1.1.2026

EN



JASMIN 7 in SAGE ST CPL decor, with BELLA SLIM handle shiny brass

## ERKADO

doors are our world

Interior doors are a part of every home's furnishings. That's why looking at doors only through the lens of utility and functionality has long been insufficient. Today, they are an important element of interior architecture, highlighting the advantages of a perfectly arranged home. That's why we create modern solutions, introduce attractive designs, and care about the quality of workmanship, allowing you to enjoy your choice of Erkado doors.

We care about developing all key areas of our business to create a product that meets your expectations. We achieve this goal through investments in technologically advanced production lines, employee training, and systematic analysis of consumer needs. Dynamic growth would not be possible without the activity of our sales network participants. Thank you for your inspiring suggestions and expressions of appreciation.



<b>STILE DOORS</b> .....			<b>5</b>
WERBENA.....	<b>NEW</b>	6	
LAURENCJA.....		8	
FREZZA.....		10	
JASMIN.....	<b>NEW</b>	12	
NEMEZJA.....		14	
PEONIA.....		16	
AMARYLIS.....		18	
MISKANT.....		20	
MAGNOLIA.....		22	
BUDLEJA, POWOJNIK.....		24	
LUKRECJA.....		26	
EPIEDIUM.....		28	
ARALIA, NOLINA, EWODIA.....		30	
JUKA.....	<b>BEST PRICE!</b>	32	
FORSYCJA.....	<b>BEST PRICE!</b>	34	
LAWENDA.....	<b>BEST PRICE!</b>	36	
IRYS.....		38	
DAGLEZJA.....		40	
DEBECJA.....		42	
SURMIA.....		44	
BERBERYS, FLOKS.....		46	
KROKUS.....		48	
KAMELIA.....		50	
PETUNIA.....		52	
AZALIA.....		54	
HIACYNT.....		56	
FRAGI.....		58	
<b>LOFT GLASS DOORS</b> .....	<b>NEW</b>		<b>60</b>
LOFT BASIC.....	<b>NEW</b>	60	
LOFT CLASSIC.....	<b>NEW</b>	62	
LOFT ART.....	<b>NEW</b>	64	
<b>GRAF GLASS DOORS</b> .....	<b>NEW</b>		<b>68</b>
<b>DECORATIVE LAMELLAS</b> .....			<b>72</b>
<b>LACQUERED DOORS</b> .....			<b>74</b>
WERBENA.....	<b>NEW</b>	74	
JASMIN.....	<b>NEW</b>	76	
AMARYLIS.....		78	
PEONIA.....		80	
MISKANT.....		82	
NEMEZJA.....		84	
LAURENCJA.....		86	
BALDUR.....		88	
ANUBIS.....		90	
UNO PREMIUM.....		92	
TURAN.....		94	
MILDA.....		96	
SYLENA.....		98	
<b>INLAYS</b> .....	<b>NEW</b>		<b>100</b>
<b>FLUSH DOORS</b> .....			<b>108</b>
BALDUR.....		108	
UNO PREMIUM.....		110	
ALTAMURA.....		112	
ANSEDONIA.....		114	
LORIENT.....		116	
MENTON.....		118	
SORANO.....		120	
<b>INTERNAL ENTRANCE DOORS</b> .....			<b>122</b>
FORTECA RC2.....		122	
FORTECA RC3.....		122	
FIXED DOOR FRAME FOR FORTECA.....		126	
STEEL DOOR FRAMES FOR FORTECA.....		127	
HERSE SET and HERSE MAX SET.....		128	
FIXED AND ADJUSTABLE DOOR FRAME FOR THE HERSE SET SERIES.....		130	
STEEL DOOR FRAMES FOR THE HERSE SET SERIES.....		132	
UNITED STEEL DOOR FRAME FOR THE HERSE SET SERIES.....		133	
<b>INTERNAL ENTRANCE FIRE DOORS</b> .....			<b>134</b>
LEDA EI30.....		134	
LEDA EI60.....		134	
WOODEN FRAME FOR THE LEDA SERIES.....		136	
STEEL DOOR FRAMES FOR THE LEDA SERIES.....		136	
DOUBLE-LEAF LEDA EI30 and EI60.....		137	
<b>HARDWARE – HANDLES</b> .....	<b>NEW</b>		<b>138</b>
<b>TECHNICAL INFORMATION</b> .....			<b>149</b>
<b>CROSSHEADS AND PILASTERS</b> .....			<b>155</b>
<b>DOOR FRAME EXTENSION PANELS</b> .....			<b>156</b>
<b>WALL-MOUNTED SLIDING SYSTEMS</b> .....			<b>158</b>
<b>SLIDING SYSTEMS HIDDEN IN THE WALL</b> .....			<b>164</b>
<b>DOUBLE-LEAF DOORS</b> .....			<b>167</b>
<b>FOLDING DOORS</b> .....			<b>170</b>
<b>COVERT CONCEALED DOOR SYSTEM</b> .....			<b>171</b>
<b>SIDELIGHTS FOR DOORS</b> .....			<b>174</b>
<b>FRAMES</b> .....			<b>176</b>
ADJUSTABLE TUNNEL-TYPE FRAME.....		179	
STEEL FRAME.....		180	
STEEL FRAME WITHOUT REBATE.....		181	
OVERLAY ADJUSTABLE FRAME FOR STEEL FRAME.....		182	
REVERSE DOOR FRAME.....		183	
ADJUSTABLE FRAME FOR DOOR LEAF WITHOUT REBATE.....		184	
FIXED DOOR FRAME FOR A REBATED DOOR LEAF.....		185	
ADJUSTABLE FRAME FOR REBATED DOOR LEAF.....		186	



# DECORS

COLOURS AVAILABLE FOR INTERIOR DOORS

## GREKO



WALNUT GREKO



MEDIUM OAK GREKO



GOLDEN OAK GREKO



OAK GREKO



GREY OAK GREKO



SONOMA GREKO



LIGHT ACACIA GREKO



WHITE GREKO  
(similar to: RAL 9010,  
NCS S 0502-Y50R)



SNOW-WHITE GREKO  
(similar to: RAL 9016,  
NCS S 0300-N)

## PREMIUM



GRAPHITE ASH PREMIUM



OAK PREMIUM



NATUR OAK PREMIUM

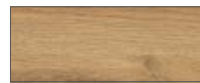

NATUR OAK TRANSVERSE  
PREMIUM<sup>1)</sup>

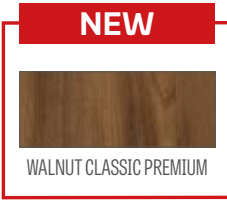

WALNUT CLASSIC PREMIUM



CONCRETE PREMIUM



GREY MAPLE PREMIUM



WHITE BARK PREMIUM



WHITE PREMIUM  
(similar to: RAL 9003,  
NCS S 0500-N)

## CPL



WENGE DARK ST CPL



OAK ST CPL



GREY OAK ST CPL



LIGHT GREY ST CPL<sup>1)</sup>  
(similar to: RAL 7037,  
NCS S 5500-N)



ASH GREY ST CPL<sup>1)</sup>  
(similar to: RAL 7047,  
NCS S 2500-N)



NEW  
STONE GREY ST CPL<sup>1)</sup>  
(similar to: RAL 1019,  
NCS S 4005-Y20R)



BLACK ST CPL<sup>1)</sup>  
(similar to: RAL 9011,  
NCS S 9000-N)



NAVY BLUE ST CPL<sup>1)2)</sup>  
(similar to: RAL 5011,  
NCS 8010-R90B)



DARK GREEN ST CPL<sup>1)</sup>  
(similar to: RAL 6007,  
NCS S 8010-G30Y)



WHITE ST CPL<sup>1)</sup>  
(similar to: RAL 9003,  
NCS S 0500-N)



CAPPUCCINO ST CPL<sup>1)</sup>  
(similar to: RAL D2 080 80 05  
NCS S 3005-Y50R)



NEW  
SAGE ST CPL<sup>1)</sup>  
(similar to: RAL 7033,  
NCS S 4005-G20Y)



ANTHRACITE ST CPL<sup>1)</sup>  
(similar to: RAL 7024  
NCS S 8000-N)



ANTHRACITE SATIN CPL 0.2 and 0.7  
(similar to: RAL 7024  
NCS S 8000-N)

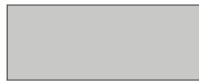

ASH-GREY CPL 0.2 and 0.7  
(similar to: RAL 7047,  
NCS S 2500-N)

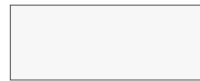

WHITE CPL 0.2 and 0.7  
(similar to: RAL 9003,  
NCS S 0300-N)

## UV LACQUER



WHITE TITANIUM UV  
(similar to: RAL 9003,  
NCS S 0500-N)



NEW  
CASHMERE TITANIUM UV  
(similar to: RAL D2 080 80 05  
NCS S 3005-Y50R)

## POWDER-COATED in the LOFT collection



BLACK STR (RAL 9005)



WHITE STR (RAL 9003)



RAL 5002



RAL 6005



RAL 7006



RAL 7016



RAL 7024



RAL 7032



RAL 8017



RAL 9007



RAL 9010

\* special **AntiFinger** coating limiting dirt and fingerprints

<sup>1)</sup> used only in selected panel door leaves. In the set, the frame is made in the NATUR OAK PREMIUM decor

<sup>2)</sup> while stocks last

# STILE DOORS

REBATED AND NON-REBATED

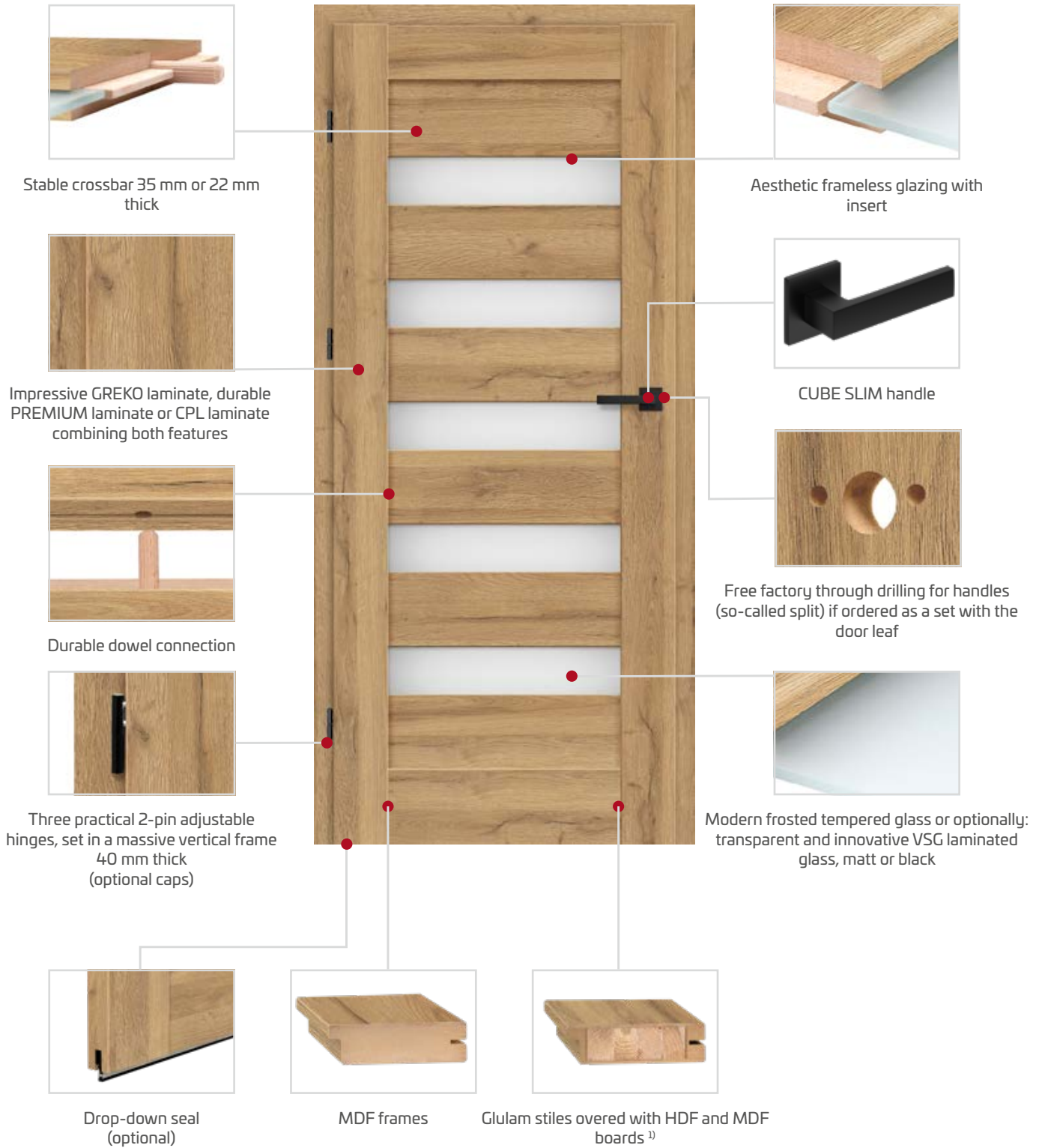

<sup>1)</sup> Available at extra charge in rebated, non-rebated and flush models for sliding systems in PL and CZ standards for WHITE PREMIUM, NATUR OAK PREMIUM, GRAPHITE ASH PREMIUM, GREY MAPLE PREMIUM, OAK ST CPL decors



# WERBENA

REBATED AND NON-REBATED INTERIOR STILE DOORS



WERBENA 1 in SAGE ST CPL decor, with QUANTA FIT handle black matt



WERBENA 1



WERBENA 2



WERBENA 3



WERBENA 4



WERBENA 5

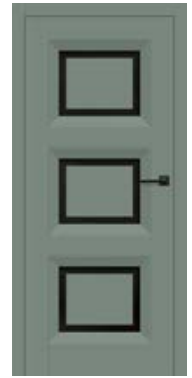

WERBENA 6



WERBENA 7



WERBENA 8



WERBENA 9

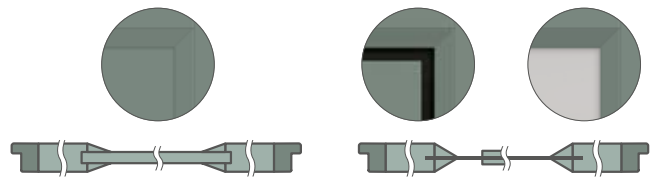

WERBENA 1, 2, 3  
beveled strip at 16 mm panel

WERBENA 4, 5, 6, 7, 8, 9  
deep beveled strip by the glass

WERBENA 4, 5, 6  
panel edge 3 mm thick always in  
black color



WERBENA 4 in SAGE ST CPL decor, with BELLA SLIM shiny chrome handle

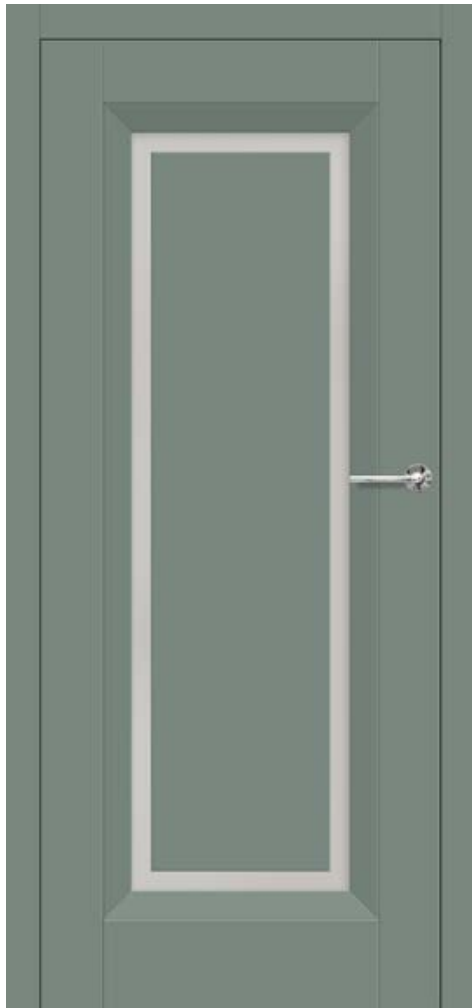

DESIGN

- rebated or non-rebated door leaf made with STILE frame technology
- vertical and horizontal stiles made of MDF board covered with PREMIUM, ST CPL laminates, or ST CPL laminate with AntiFinger coating
- vertical rails made of glulam covered with HDF and MDF boards<sup>4)</sup>
- WERBENA 1, 2, 3 – panels made of 16 mm MDF board framed with a thin beveled strip; WERBENA 4, 5, 6 – panels made of 3 mm HDF board glued on both sides to glass, framed with a deep beveled strip. **The panel edge is always made in black color:**
- transparency width between the beveled strip and the glued panel 40 mm
- optional, with extra charges: door frame extension panels and a crosshead with pilasters, pp. 155–157.
- possibility to shorten the door leaf on your own, details p. 153

HARDWARE

- three silver 2-pin hinges with horizontal adjustment in the rebated door leaf or, for an extra charge, black ones
- two hinges (third for an extra charge) concealed in the non-rebated door leaf painted in silver color (optionally for an extra charge in black, gold or white); hinges are supplied and priced with the frame
- latch-bolt lock in the rebated door leaf and magnetic (optionally latch-bolt) in the non-rebated door leaf for key, patent insert, economy or with lock in silver color (for an extra charge in black); optionally for an extra charge, magnetic lock in black, gold or white color

GLAZING

- standard: frosted or clear tempered glass 4 mm and for an extra charge laminated glass VSG 221 frosted or black safety, smooth on both sides or decorative tempered glass 4 mm relief and point **NEW** (WERBENA 7, 8, 9). Relief and point glass is smooth on one side.
- possibility to change the glazing side to REVERSE (OBVERSE is standard glazing), p. 154

AVAILABLE SOLUTIONS (pp. 158-169)



AVAILABLE DOOR LEAF WIDTHS **NEW**

60	65	70	75	80N <sup>5)</sup>	80	85	90	95	100
----	----	----	----	-------------------	----	----	----	----	-----

PREMIUM

NATUR OAK PREMIUM <sup>4)</sup>	OAK PREMIUM	GRAPHITE ASH PREMIUM <sup>4)</sup>	WALNUT CLASSIC PREMIUM
			<b>NEW</b>
GREY MAPLE PREMIUM <sup>4)</sup>	WHITE BARK PREMIUM	WHITE PREMIUM <sup>1)4)</sup>	

CPL

WENGE DARK ST CPL	OAK ST CPL <sup>4)</sup>	GREY OAK ST CPL	ANTHRACITE ST CPL <sup>3)</sup>
BLACK ST CPL <sup>3)</sup>	DARK GREEN ST CPL <sup>3)</sup>	NAVY BLUE ST CPL <sup>3)6)</sup>	WHITE ST CPL <sup>1)3)</sup>
LIGHT GREY ST CPL <sup>3)</sup>	ASH GREY ST CPL <sup>3)</sup>	CAPPUCINO ST CPL <sup>3)</sup>	
		<b>NEW</b>	
SAGE ST CPL <sup>3)</sup>	STONE GREY ST CPL <sup>3)</sup>		



Glulam stiles<sup>4)</sup>

EXTRA CHARGES

- factory through drilling for handles (so-called split) ordered as a set with the door leaf
- enhanced airflow trim standard or mini, ventilation undercut standard or mini (p. 153)
- wood-like plastic sleeves (4 pcs.)
- metal sleeves round and square (4 pcs.); finish: brushed nickel, patina, white and black
- ventilation grille (only for door leaves with widths: 80, 90, 100)
- rebated and non-rebated door leaf "100"
- laminated glass VSG 221 safety glass, smooth on both sides or decorative glass
- metal caps for hinges in rebated door leaves (color: brushed nickel, patina, shiny chrome, shiny brass, white and black)
- change to hinges, strike plate and lock in black color for rebated door leaves
- drop-down seal
- change to magnetic lock in black, white or gold color for non-rebated door leaves
- change to hinges and strike plate in black, white or gold for non-rebated door leaves
- glulam stiles<sup>4)</sup>
- standard PL2112 +15% to the price of the door leaf before extra charges

<sup>1)</sup> smooth white laminate imitating a painted surface  
<sup>3)</sup> special **AntiFinger** coating reducing dirt and fingerprints  
<sup>4)</sup> vertical stiles made of glulam covered with HDF and MDF boards available at extra charge for decors WHITE PREMIUM, NATUR OAK PREMIUM, GRAPHITE ASH PREMIUM, GREY MAPLE PREMIUM, OAK ST CPL  
<sup>5)</sup> only for non-rebated doors<sup>6)</sup> while stocks last



# LAURENCJA

REBATED AND NON-REBATED INTERIOR STILE DOORS



LAURENCJA 1 in WHITE ST CPL decor, with black VSG glazing, with QUANTA FIT handle in black matt



LAURENCJA 1



LAURENCJA 2



LAURENCJA 3



LAURENCJA 4



LAURENCJA 5



LAURENCJA 6

LAURENCJA 1 in WHITE PREMIUM decor, with CUBE PREMIUM handle in black matt and black laminated VSG 221 glass



## DESIGN

- rebated or non-rebated door leaf made with STILE frame technology
- vertical and horizontal stiles made of MDF board covered with PREMIUM, ST CPL laminates, or ST CPL laminate with AntiFinger coating
- vertical rails made of glulam covered with HDF and MDF boards<sup>4)</sup>
- panels made of 4 mm thick HDF board covered with CPL or PREMIUM laminate
- very wide rail, thickness 35 mm
- optional, with extra charges: door frame extension panels and a crosshead with pilasters, pp. 155-157.
- possibility to shorten the door leaf on your own, details p. 153

## HARDWARE

- three silver 2-pin hinges with horizontal adjustment in the rebated door leaf or, for an extra charge, black ones
- two hinges (third for an extra charge) concealed in the non-rebated door leaf painted in silver color (optionally for an extra charge in black, gold or white); hinges are supplied and priced with the frame
- latch-bolt lock in the rebated door leaf and magnetic (optionally latch-bolt) in the non-rebated door leaf for key, patent insert, economy or with lock in silver color (for an extra charge in black); optionally for an extra charge, magnetic lock in black, gold or white color

## GLAZING

- standard: frosted or clear glass 4 mm, and for an extra charge laminated VSG 221 glass, frosted or black safe, smooth on both sides
- possibility to change the glazing side to REVERSE (OBVERSE is standard glazing), p. 154

## AVAILABLE SOLUTIONS (pp. 158-169)



## AVAILABLE DOOR LEAF WIDTHS NEW

60	65	70	75	80N <sup>5)</sup>	80	85	90	95	100
----	----	----	----	-------------------	----	----	----	----	-----

## PREMIUM

NATUR OAK PREMIUM <sup>4)</sup>	OAK PREMIUM	GRAPHITE ASH PREMIUM <sup>4)</sup>	WALNUT CLASSIC PREMIUM
			<b>NEW</b>
GREY MAPLE PREMIUM <sup>4)</sup>	WHITE BARK PREMIUM	WHITE PREMIUM <sup>1)4)</sup>	

## CPL

WENGE DARK ST CPL	OAK ST CPL <sup>4)</sup>	GREY OAK ST CPL	ANTHRACITE ST CPL <sup>3)</sup>
BLACK ST CPL <sup>3)</sup>	DARK GREEN ST CPL <sup>3)</sup>	NAVY BLUE ST CPL <sup>3)5)</sup>	WHITE ST CPL <sup>1)3)</sup>
LIGHT GREY ST CPL <sup>3)</sup>	ASH GREY ST CPL <sup>3)</sup>	CAPPUCCINO ST CPL <sup>3)</sup>	
		<b>NEW</b>	
SAGE ST CPL <sup>3)</sup>	STONE GREY ST CPL <sup>3)</sup>		



Glulam stiles<sup>4)</sup>

## EXTRA CHARGES

factory through drilling for handles (so-called split) ordered as a set with the door leaf

enhanced airflow trim standard or mini, ventilation undercut standard or mini (p. 153)

wood-like plastic sleeves (4 pcs.)

metal sleeves round and square (4 pcs.); finish: brushed nickel, patina, white and black

ventilation grille (only for door leaves with widths: 80, 90, 100)

rebated and non-rebated door leaf "100"

laminated VSG 221 glass, safe, smooth on both sides

metal caps for hinges in rebated door leaves

(color: brushed nickel, patina, shiny chrome, shiny brass, white and black)

change to hinges, strike plate and lock in black color for rebated door leaves

drop-down seal

change to magnetic lock in black, white or gold color for non-rebated door leaves

change to hinges and strike plate in black, white or gold for non-rebated door leaves

glulam stiles<sup>4)</sup>

<sup>1)</sup> smooth white laminate imitating a painted surface

<sup>3)</sup> special **AntiFinger** coating reducing dirt and fingerprints

<sup>4)</sup> vertical stiles made of glulam covered with HDF and MDF boards available at extra charge for decors WHITE PREMIUM, NATUR OAK PREMIUM, GRAPHITE ASH PREMIUM, GREY MAPLE PREMIUM, OAK ST CPL

<sup>5)</sup> only for non-rebated doors<sup>6)</sup> while stocks last



# FREZJA

REBATED AND NON-REBATED INTERIOR STILE DOORS



FREZJA 9 in CAPPUCCINO ST CPL decor, with BELLA SLIM handle in shiny brass



FREZJA 1



FREZJA 2



FREZJA 3



FREZJA 4

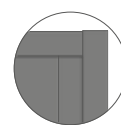

FREZJA 2

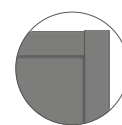

FREZJA 4

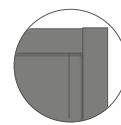

FREZJA 6



FREZJA 9  
panel edge 3 mm thick always  
in black color



FREZJA 5



FREZJA 6



FREZJA 7 <sup>3)</sup>



FREZJA 8 <sup>2)</sup>



FREZJA 8  
ventilation undercut

<sup>2)</sup> FREZJA 8 - glass thickness 8 mm

<sup>3)</sup> FREZJA 7 - model only with mirror; other side - board laminated in the given decor. OBVERSE - mirror on the hinge side (as in the photo)

FREZJA 9<sup>®</sup> in LIGHT GREY ST CPL decor, with QUANTA FT handle in black matt

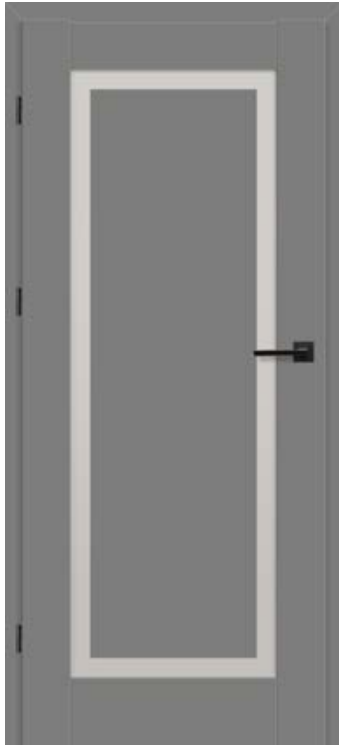

## DESIGN

- rebated or non-rebated door leaf made with STILE frame technology
- vertical and horizontal stiles made of MDF board covered with GREKO, PREMIUM, ST CPL laminates or ST CPL laminate with AntiFinger coating
- vertical stiles made of glulam covered with HDF and MDF boards<sup>6)</sup>
- panels made of 16 mm thick HDF board (in FREZJA 2 and 6 also 4 mm panel) covered with GREKO, CPL or PREMIUM laminates. FREZJA 7 available only with a mirror
- in FREZJA 9 model, a 3 mm HDF panel is glued on both sides of the glass. **The panel edge is always made in black.**
- optional, with extra charges: door frame extension panels and a crosshead with pilasters, pp. 155-157.
- possibility to shorten the door leaf on your own, details p. 153

## HARDWARE

- three silver 2-pin hinges with horizontal adjustment in the rebated door leaf or, for an extra charge, black ones
- two hinges (third for an extra charge) hidden in the non-rebated door leaf, painted silver (optionally for an extra charge in black, gold or white); hinges are supplied and priced with the frame
- latch-bolt lock in rebated door leaf and magnetic (optionally latch-bolt) in non-rebated door leaf for key, patent insert, economy or with lock in silver (optionally for an extra charge in black); optionally for an extra charge magnetic lock in black, gold or white

## GLAZING

- standard: tempered frosted glass, clear 4 mm or one-sided mirror (only Frezja 7) and for an extra charge: laminated VSG 221 glass, frosted or black safe, smooth on both sides (for FREZJA 1, 3, 5) or decorative tempered glass 4 mm relief and point **NEW** (for FREZJA 1, 3, 5). Relief and point glass is smooth on one side.
- possibility to change the glazing side to REVERSE (OBSERVE is standard glazing), p. 154
- fixed glazing width; FREZJA 1 – 140 mm, FREZJA 5 – 80 mm, FREZJA 9 – 50 mm

## GREKO

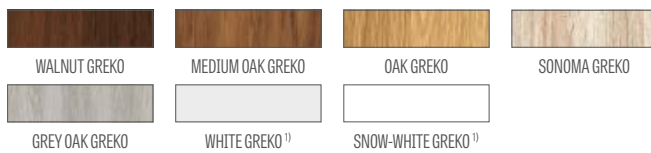

## PREMIUM



## CPL

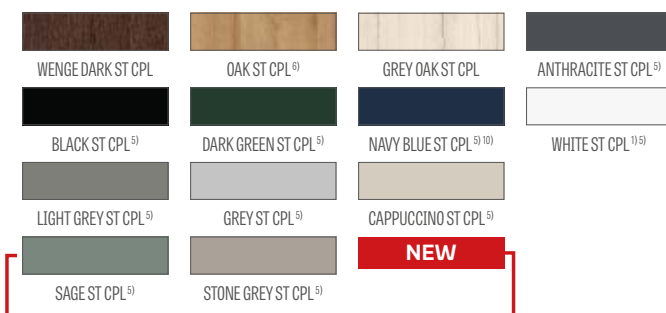

Glulam stiles<sup>6)</sup>

## AVAILABLE SOLUTIONS (pp. 158-169)

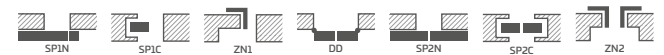

## AVAILABLE DOOR LEAF WIDTHS **NEW**



## EXTRA CHARGES

- factory through drilling for handles (so-called split) ordered as a set with the door leaf
- enhanced airflow trim standard or mini, ventilation undercut standard or mini (p. 153)
- wood-like plastic sleeves (4 pcs.)<sup>2)</sup>
- round and square metal sleeves<sup>2)</sup> (4 pcs.); finish: brushed nickel, patina, white and black
- ventilation grille<sup>2)</sup> (only for door leaves with widths: 80, 90, 100)
- rebated and non-rebated door leaf "100"
- laminated glass VSG 221 safety glass, smooth on both sides or decorative glass
- metal caps for hinges in rebated door leaves (colours: brushed nickel, patina, glossy chrome, glossy brass, white, and black)
- change to hinges, strike plate and lock in black color for rebated door leaves
- drop-down seal (not available for FREZJA 8)
- change to magnetic lock in black, white or gold color for non-rebated door leaves
- change to hinges and strike plate in black, white or gold for non-rebated door leaves
- glulam stiles<sup>6)</sup>
- standard PL2112<sup>9)</sup> +15% to the price of the door leaf before extra charges

<sup>1)</sup> smooth white laminate imitating a painted surface

<sup>2)</sup> not available in FREZJA 8

<sup>3)</sup> FREZJA 8 is not available in sliding systems

<sup>5)</sup> special **AntiFinger** coating limiting dirt and fingerprints

<sup>6)</sup> vertical stiles made of glulam covered with HDF and MDF boards available at extra charge for decors WHITE PREMIUM, NATUR OAK PREMIUM, GRAPHITE ASH PREMIUM, GREY MAPLE PREMIUM, OAK ST CPL

<sup>7)</sup> only for non-rebated door leaves

<sup>8)</sup> **FREZJA 9 model available in PREMIUM and ST CPL decors**

<sup>9)</sup> not available for GREKO decors<sup>10)</sup> while stocks last



# JASMIN

REBATED AND NON-REBATED INTERIOR STILE DOORS

REGISTERED DESIGN  
**ERKADO**  
015099362-0001/015099362-0006



JASMIN 3 in CAPPUCCINO ST CPL decor, with BELLA SLIM handle black matt



JASMIN 1



JASMIN 2



JASMIN 3



JASMIN 4



JASMIN 5<sup>\*)</sup>



JASMIN 6<sup>\*)</sup>



JASMIN 7<sup>\*)</sup>



JASMIN 8<sup>\*)</sup>



JASMIN  
panel edge 3 mm thick always in  
black color

<sup>\*)</sup> The presented photos of JASMIN 5-8 doors refer only to the door leaf width "80". In other widths, there are differences in the proportions of the radii of the central panel in relation to the glass, which may affect the customer's product choice. Graphics showing the individual widths can be found at [www.erkado.pl](http://www.erkado.pl)

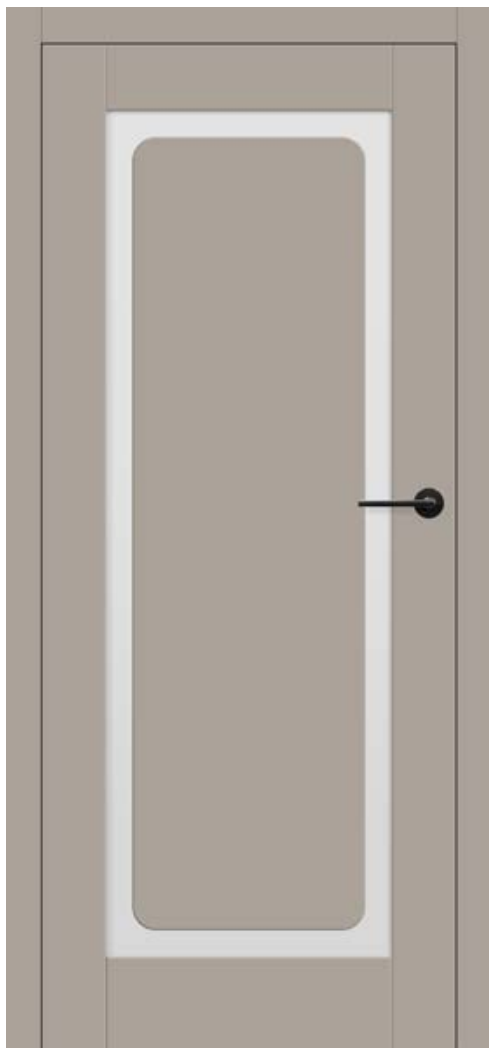

JASMIN 1 in STONE GREY ST CPL decor, with BELLA SLIM handle black matt

**DESIGN**

- rebated or non-rebated door leaf made with STILE frame technology
- vertical and horizontal stiles made of MDF board covered with PREMIUM, ST CPL laminates, or ST CPL laminate with AntiFinger coating
- vertical rails made of glulam covered with HDF and MDF boards<sup>4)</sup>
- panels made of 3 mm HDF board glued on both sides to the glass. **The edge of the panel is always made in black.**
- the width of the transparency between the edge of the rail and the glued panel is 50 mm
- optional, with extra charges: door frame extension panels and a crosshead with pilasters, pp. 155–157.
- possibility to shorten the door leaf on your own, details p. 153

**HARDWARE**

- three silver 2-pin hinges with horizontal adjustment in the rebated door leaf or, for an extra charge, black ones
- two hinges (third for an extra charge) hidden in the non-rebated door leaf painted in silver color (optionally for an extra charge in black, gold or white); hinges are supplied and priced with the frame
- latch-bolt lock in rebated door leaf and magnetic (optionally latch-bolt) in non-rebated door leaf for key, patent insert, economy or with lock in silver (optionally for an extra charge in black); optionally for an extra charge magnetic lock in black, gold or white

**GLAZING**

- standard: tempered milk or clear glass 4 mm and for an extra charge laminated glass VSG 221 milk or black safety glass, smooth on both sides
- possibility to change the glazing side to REVERSE (OBVERSE is standard glazing), p. 154

**AVAILABLE SOLUTIONS** (pp. 158-169)



**AVAILABLE DOOR LEAF WIDTHS** NEW

60	65	70	75	80N <sup>5)</sup>	80	85	90	95	100
----	----	----	----	-------------------	----	----	----	----	-----

**PREMIUM**

NATUR OAK PREMIUM <sup>4)</sup>	OAK PREMIUM	GRAPHITE ASH PREMIUM <sup>4)</sup>	WALNUT CLASSIC PREMIUM
			<b>NEW</b>
GREY MAPLE PREMIUM <sup>4)</sup>	WHITE BARK PREMIUM	WHITE PREMIUM <sup>1)4)</sup>	

**CPL**

WENGE DARK ST CPL	OAK ST CPL <sup>4)</sup>	GREY OAK ST CPL	ANTHRACITE ST CPL <sup>3)</sup>
BLACK ST CPL <sup>3)</sup>	DARK GREEN ST CPL <sup>3)</sup>	NAVY BLUE ST CPL <sup>3)5)</sup>	WHITE ST CPL <sup>1)3)</sup>
LIGHT GREY ST CPL <sup>3)</sup>	ASH GREY ST CPL <sup>3)</sup>	CAPPUCCINO ST CPL <sup>3)</sup>	
		<b>NEW</b>	
SAGE ST CPL <sup>3)</sup>	STONE GREY ST CPL <sup>3)</sup>		

**EXTRA CHARGES**

- factory through drilling for handles (so-called split) ordered as a set with the door leaf
- enhanced airflow trim standard or mini, ventilation undercut standard or mini (p. 153)
- wood-like plastic sleeves (4 pcs.)
- metal sleeves round and square (4 pcs.); finish: brushed nickel, patina, white and black
- ventilation grille (only for door leaves with widths: 80, 90, 100)
- rebated and non-rebated door leaf "100"
- laminated glass VSG 221 safety glass, smooth on both side
- metal caps for hinges in rebated door leaves (color: brushed nickel, patina, shiny chrome, shiny brass, white and black)
- change to hinges, strike plate and lock in black color for rebated door leaves
- drop-down seal
- change to magnetic lock in black, white or gold color for non-rebated door leaves
- change to hinges and strike plate in black, white or gold for non-rebated door leaves
- glulam stiles<sup>4)</sup>
- standard PL2112 +15% to the price of the door leaf before extra charges



<sup>1)</sup> smooth white laminate imitating a painted surface  
<sup>3)</sup> special **AntiFinger** coating reducing dirt and fingerprints  
<sup>4)</sup> vertical rails made of glulam covered with HDF and MDF boards available for an extra charge for the decors WHITE PREMIUM, NATUR OAK PREMIUM, GRAPHITE ASH PREMIUM, GREY MAPLE PREMIUM, OAK ST CPL  
<sup>5)</sup> only for non-rebated doors<sup>6)</sup> while stocks last



# NEMEZJA

REBATED AND NON-REBATED INTERIOR STILE DOORS



NEMEZJA 14 in ANTHRACITE ST CPL decor, with QUANTA FIT handle black matt



NEMEZJA 4



NEMEZJA 6



NEMEZJA 7



NEMEZJA 8



NEMEZJA 9

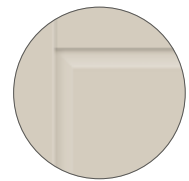

Beveled panel



NEMEZJA 10



NEMEZJA 11



NEMEZJA 12



NEMEZJA 15



NEMEZJA 16

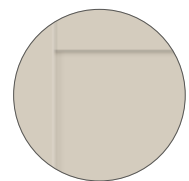

NEMEZJA 16  
Straight panel

NEMEZJA 16 in CAPPUCCINO ST CPL decor, with QUANTA FIT handle black matt



**NEW**

## DESIGN

- rebated or non-rebated door leaf made with STILE frame technology
- vertical and horizontal rails made of MDF board covered with GREKO, PREMIUM, ST CPL or ST CPL laminate with AntiFinger coating
- vertical rails made of glulam covered with HDF and MDF boards<sup>4)</sup>
- panels made of 16 mm thick HDF board, beveled and smooth (only NEMEZJA 16), covered with laminate in selected GREKO, CPL or PREMIUM decors
- optional, with extra charges: door frame extension panels and a crosshead with pilasters, pp. 155-157.
- possibility to shorten the door leaf on your own, details p. 153

## HARDWARE

- three silver 2-pin hinges with horizontal adjustment in the rebated door leaf or, for an extra charge, black ones
- two hinges (third for an extra charge) concealed in the non-rebated door leaf painted in silver color (optionally for an extra charge in black, gold or white); hinges are supplied and priced with the frame
- latch-bolt lock in rebated door leaf and magnetic (optionally latch-bolt) in non-rebated door leaf for key, patent insert, economy or with lock in silver (optionally for an extra charge in black); optionally for an extra charge magnetic lock in black, gold or white

## GLAZING

- as standard, 4 mm tempered frosted or clear glass and, for an extra charge, VSG 221 laminated glass, frosted or black safety glass, smooth on both sides or 4 mm decorative tempered glass relief and point **NEW** for NEMEZJA 4, 7, 11, 15 (relief and point glass smooth on one side)
- possibility to change the glazing side to REVERSE (OBERSE is standard glazing), p. 154

### GREKO

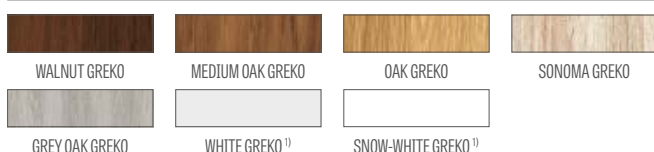

### PREMIUM



### CPL

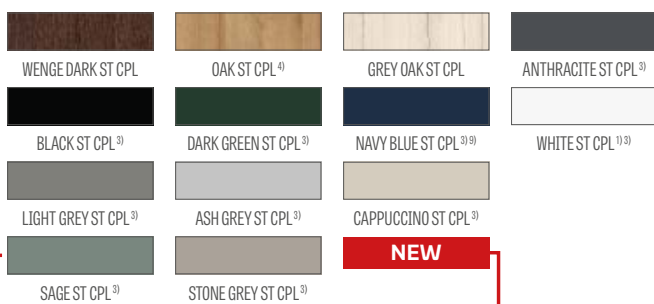

Glulam stiles<sup>4)</sup>

## AVAILABLE SOLUTIONS (pp. 158-169)



## AVAILABLE DOOR LEAF WIDTHS **NEW**



## EXTRA CHARGES

- factory through drilling for handles (so-called split) ordered as a set with the door leaf
- enhanced airflow trim standard or mini, ventilation undercut standard or mini (p. 153)
- wood-like plastic sleeves (4 pcs.)
- metal sleeves round and square (4 pcs.); finish: brushed nickel, patina, white and black
- ventilation grille (only for door leaves with widths: 80, 90, 100)
- rebated and non-rebated door leaf "100"
- laminated glass VSG 221 safety glass, smooth on both sides or decorative glass
- metal caps for hinges in rebated door leaves (colours: brushed nickel, patina, glossy chrome, glossy brass, white, and black)
- change to hinges, strike plate and lock in black color for rebated door leaves
- drop-down seal
- change to magnetic lock in black, white or gold color for non-rebated door leaves
- change to hinges and strike plate in black, white or gold for non-rebated door leaves
- glulam stiles<sup>4)</sup>
- standard PL2112<sup>3)</sup> +15% to the price of the door leaf before extra charges

<sup>1)</sup> smooth white laminate imitating a painted surface

<sup>3)</sup> special **AntiFinger** coating reducing dirt and fingerprints

<sup>4)</sup> vertical stiles made of glulam covered with HDF and MDF boards available at extra charge for decors WHITE PREMIUM, NATUR OAK PREMIUM, GRAPHITE ASH PREMIUM, GREY MAPLE PREMIUM, OAK ST CPL

<sup>5)</sup> only for non-rebated door leaves

<sup>7)</sup> decorative crosshead with pilasters available at extra charge, p. 155

<sup>8)</sup> not available for GREKO decors <sup>9)</sup> while stocks last



# PEONIA

REBATED AND NON-REBATED INTERIOR STILE DOORS



PEONIA 2 in SAGE ST CPL decor, with frosted glazing, with BELLA SLIM handle shiny brass, with decorative crosshead and pilasters<sup>6)</sup>



PEONIA 1



PEONIA 2



PEONIA 3



PEONIA 4



PEONIA 5



PEONIA 6



Double-sided adhesive muntin width 25 mm  
in the color of the door leaf or black

PEONIA 3 in SAGE ST CPL decor, with CUBE PREMIUM handle black matt, with decorative crosshead and pilasters<sup>6)</sup>



## GREKO



## PREMIUM



## CPL

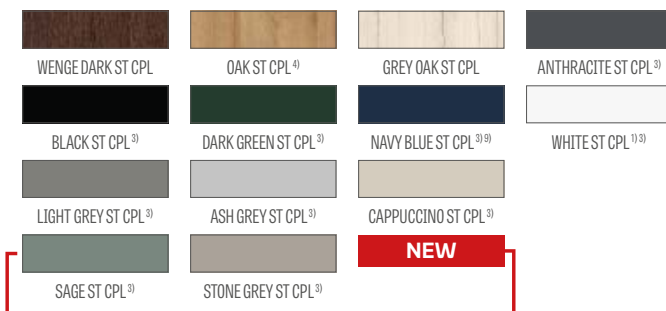

Glulam stiles<sup>4)</sup>

## DESIGN

- rebated or non-rebated door leaf made with STILE frame technology
- vertical and horizontal rails made of MDF board covered with GREKO, PREMIUM, ST CPL laminates or ST CPL laminate with AntiFinger coating
- vertical rails made of glulam covered with HDF and MDF boards<sup>4)</sup>
- panels made of 16 mm thick HDF board, beveled and covered with laminate in selected GREKO, CPL or PREMIUM decors
- double-sided muntin glued on glass, width 25 mm and height respectively: vertical 12 mm and horizontal 8 mm
- optionally, possibility to change the muntin decor to BLACK ST CPL color regardless of the door leaf decor
- optional, with extra charges: door frame extension panels and a crosshead with pilasters, pp. 155-157.
- possibility to shorten the door leaf on your own, details p. 153

## HARDWARE

- three silver 2-pin hinges with horizontal adjustment in the rebated door leaf or, for an extra charge, black ones
- two hinges (third for an extra charge) concealed in the non-rebated door leaf painted in silver color (optionally for an extra charge in black, gold or white); hinges are supplied and priced with the frame
- latch-bolt lock in rebated door leaf and magnetic (optionally latch-bolt) in non-rebated door leaf for key, patent insert, economy or with lock in silver (optionally for an extra charge in black); optionally for an extra charge magnetic lock in black, gold or white

## GLAZING

- as standard, 4 mm tempered frosted or clear glass and, for an extra charge, VSG 221 laminated glass, frosted or black safety glass, smooth on both sides or 4 mm decorative tempered glass relief and point **NEW** (relief and point glass smooth on one side)
- possibility to change the glazing side to REVERSE (OBVERSE is standard glazing), p. 154

## AVAILABLE SOLUTIONS (pp. 158-169)



## AVAILABLE DOOR LEAF WIDTHS **NEW**



## EXTRA CHARGES

factory through drilling for handles (so-called split) ordered as a set with the door leaf enhanced airflow trim standard or mini, ventilation undercut standard or mini (p. 153)

wood-like plastic sleeves (4 pcs.)

metal sleeves round and square (4 pcs.); finish: brushed nickel, patina, white and black

ventilation grille (only for door leaves with widths: 80, 90, 100)

rebated and non-rebated door leaf "100"

laminated glass VSG 221 safety glass, smooth on both sides or decorative glass

metal caps for hinges in rebated door leaves (colours: brushed nickel, patina, glossy chrome, glossy brass, white, and black)

change to hinges, strike plate and lock in black color for rebated door leaves

drop-down seal

change to magnetic lock in black, white or gold color for non-rebated door leaves

replacement with hinges and strike plate in black, white or gold for non-rebated door leaves

glulam stiles<sup>4)</sup>

standard PL2112<sup>8)</sup>

+15% to the price of the door leaf before extra charges

<sup>1)</sup> smooth white laminate imitating a painted surface

<sup>3)</sup> special **AntiFinger** coating reducing dirt and fingerprints

<sup>4)</sup> vertical stiles made of glulam covered with HDF and MDF boards available at extra charge for decors WHITE PREMIUM, NATUR OAK PREMIUM, GRAPHITE ASH PREMIUM, GREY MAPLE PREMIUM, OAK ST CPL

<sup>5)</sup> only for non-rebated door leaves

<sup>6)</sup> decorative crosshead with pilasters available at extra charge, p. 155

<sup>8)</sup> not available for GREKO decors<sup>3)</sup> while stocks last



# AMARYLIS

REBATED AND NON-REBATED INTERIOR STILE DOORS



AMARYLIS 2 in STONE GREY ST CPL decor, with decorative relief glazing, with BELLA SLIM handle shiny brass, with decorative crosshead and pilasters<sup>7)</sup>



AMARYLIS 1

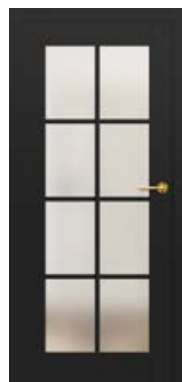

AMARYLIS 2



AMARYLIS 3



AMARYLIS 4



AMARYLIS 5



AMARYLIS 6



AMARYLIS 7



AMARYLIS 8



AMARYLIS 9



Double-sided adhesive muntin width 25 mm  
in the color of the door leaf or black

AMARYLIS 3 in NATUR OAK PREMIUM decor, with BELLA SLIM black matt handle



## DESIGN

- rebated or non-rebated door leaf made with STILE frame technology
- vertical and horizontal stiles made of MDF board covered with GREKO, PREMIUM, ST CPL laminates or ST CPL laminate with AntiFinger coating
- vertical rails made of glulam covered with HDF and MDF boards<sup>4)</sup>
- double-sided muntin glued to glass, width 25mm and height respectively: vertical 12 mm and horizontal 8 mm
- optionally, possibility to change the muntin decor to BLACK ST CPL color regardless of the door leaf decor
- optional, with extra charges: door frame extension panels and a crosshead with pilasters, pp. 155–157.
- possibility to shorten the door leaf on your own, details p. 153

## HARDWARE

- three silver 2-pin hinges with horizontal adjustment in the rebated door leaf or, for an extra charge, black ones
- two hinges (third for an extra charge) concealed in the non-rebated door leaf painted in silver color (optionally for an extra charge in black, gold or white); hinges are supplied and priced with the frame
- latch-bolt lock in rebated door leaf and magnetic (optionally latch-bolt) in non-rebated door leaf for key, patent insert, economy or with lock in silver (optionally for an extra charge in black); optionally for an extra charge magnetic lock in black, gold or white

## GLAZING

- standard: frosted or clear tempered glass 4 mm, and for an extra charge laminated VSG 221 glass, frosted or black safe, smooth on both sides, or decorative tempered glass 4 mm relief and point **NEW** (relief and point glass smooth on one side)
- possibility to change the glazing side to REVERSE (OBVERSE is standard glazing), p. 154

## GREKO



## PREMIUM



## CPL

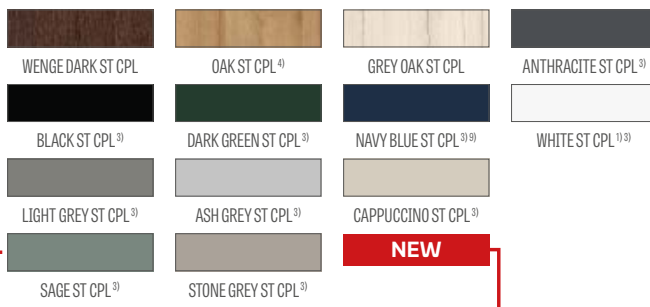

## AVAILABLE SOLUTIONS (pp. 158-169)

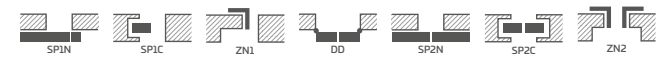

## AVAILABLE DOOR LEAF WIDTHS **NEW**



## EXTRA CHARGES

- factory through drilling for handles (so-called split) ordered as a set with the door leaf laminated glass VSG 221 safety glass, smooth on both sides or decorative glass
- enhanced airflow trim standard or mini, ventilation undercut standard or mini (p. 153)
- wood-like plastic sleeves (4 pcs.)
- metal sleeves round and square (4 pcs.); finish: brushed nickel, patina, white and black
- ventilation grille (only for door leaves with widths: 80, 90, 100)
- rebated and non-rebated door leaf "100"
- metal caps for hinges in rebated door leaves (colours: brushed nickel, patina, glossy chrome, glossy brass, white, and black)
- change to hinges, strike plate and lock in black color for rebated door leaves
- drop-down seal
- change to magnetic lock in black, white or gold color for non-rebated door leaves
- change to hinges and strike plate in black, white or gold for non-rebated door leaves
- glulam stiles<sup>4)</sup>
- standard PL2112<sup>6)</sup> +15% to the price of the door leaf before extra charges

<sup>1)</sup> smooth white laminate imitating a painted surface

<sup>3)</sup> special **AntiFinger** coating reducing dirt and fingerprints

<sup>4)</sup> vertical stiles made of glulam covered with HDF and MDF boards available at extra charge for decors WHITE PREMIUM, NATUR OAK PREMIUM, GRAPHITE ASH PREMIUM, GREY MAPLE PREMIUM, OAK ST CPL

<sup>5)</sup> only for non-rebated door leaves

<sup>7)</sup> decorative crosshead with pilasters available at extra charge, p. 155

<sup>6)</sup> not available for GREKO decors <sup>9)</sup> while stocks last



# MISKANT

REBATED AND NON-REBATED INTERIOR STILE DOORS



MISKANT 2 in NATUR OAK PREMIUM decor, with frame in BLACK ST CPL decor, with BELLA SLIM black matt handle



MISKANT 1



MISKANT 2

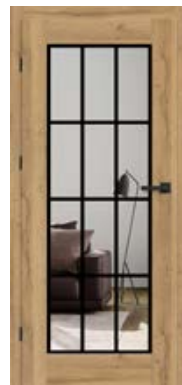

MISKANT 3



Black lines width 18 mm  
painted using screen printing  
technology



MISKANT 4



MISKANT 5



MISKANT 6

MISKANT 3 in NATUR OAK PREMIUM decor; with frame in BLACK ST CPL decor; with CUBE black matt handle

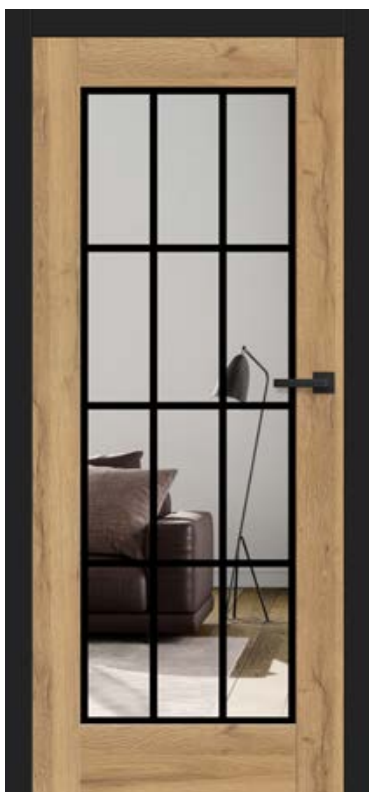

## DESIGN

- rebated or non-rebated door leaf made with STILE frame technology
- vertical and horizontal rails made of MDF board covered with GREKO, PREMIUM, ST CPL laminates or ST CPL laminate with AntiFinger coating
- vertical rails made of glulam covered with HDF and MDF boards<sup>4)</sup>
- optional, with extra charges: door frame extension panels and a crosshead with pilasters, pp. 155–157.
- possibility to shorten the door leaf on your own, details p. 153

## HARDWARE

- three silver 2-pin hinges with horizontal adjustment in the rebated door leaf or, for an extra charge, black ones
- two hinges (third for an extra charge) hidden in the non-rebated door leaf, painted silver (optionally for an extra charge in black, gold or white); hinges are supplied and priced with the frame
- latch-bolt lock in rebated door leaf and magnetic (optionally latch-bolt) in non-rebated door leaf for key, patent insert, economy or with lock in silver (optionally for an extra charge in black); optionally for an extra charge magnetic lock in black, gold or white

## GLAZING

- frosted tempered glass (MISKANT 2, 4, 6) or clear (MISKANT 1, 3, 5) thickness 4 mm or for an extra charge clear laminated VSG glass with internal application
- possibility to change the glazing side to REVERSE (OBVERSE is standard glazing), p. 154
- black lines with a width (thickness) of 18 mm painted using screen printing technology on one side of the glass

## AVAILABLE SOLUTIONS (pp. 158-169)



## AVAILABLE DOOR LEAF WIDTHS

**NEW**

60 65 70 75 80N<sup>5)</sup> 80 85 90 95 100

## GREKO



## PREMIUM



## CPL

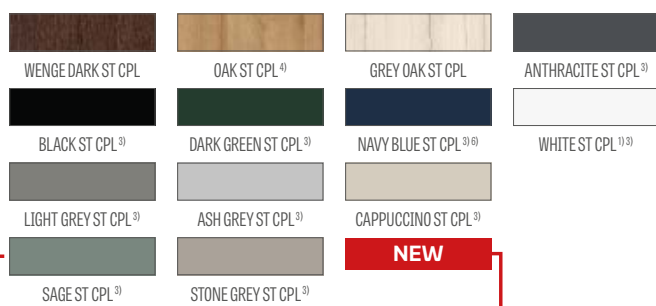

Glulam stiles<sup>4)</sup>

## EXTRA CHARGES

factory through drilling for handles (so-called split) ordered as a set with the door leaf

clear laminated VSG glass with internal application in black or white color

enhanced airflow trim standard or mini, ventilation undercut standard or mini (p. 153)

wood-like plastic sleeves (4 pcs.)

metal sleeves round and square (4 pcs.); finish: brushed nickel, patina, white and black

ventilation grille (only for door leaves with widths: 80, 90, 100)

rebated and non-rebated door leaf "100"

metal caps for hinges in rebated door leaves (colours: brushed nickel, patina, glossy chrome, glossy brass, white, and black)

change to hinges, strike plate and lock in black color for rebated door leaves

drop-down seal

change to magnetic lock in black, white or gold color for non-rebated door leaves

change to hinges and strike plate in black, white or gold for non-rebated door leaves

glulam stiles<sup>4)</sup>

<sup>1)</sup> smooth white laminate imitating a painted surface

<sup>3)</sup> special **AntiFinger** coating reducing dirt and fingerprints

<sup>4)</sup> vertical stiles made of glulam covered with HDF and MDF boards available at extra charge for decors WHITE PREMIUM, NATUR OAK PREMIUM, GRAPHITE ASH PREMIUM, GREY MAPLE PREMIUM, OAK ST CPL

<sup>5)</sup> only for non-rebated doors<sup>6)</sup> while stocks last



# MAGNOLIA

REBATED AND NON-REBATED INTERIOR STILE DOORS



MAGNOLIA 1 in OAK PREMIUM decor, with TOPAZ inox handle



MAGNOLIA 1



MAGNOLIA 2



MAGNOLIA 3



MAGNOLIA 4



MAGNOLIA 5



MAGNOLIA 6



MAGNOLIA 7



MAGNOLIA 8

MAGNOLIA 1 in OAK PREMIUM decor, with TOPAZ inox handle



## DESIGN

- rebated or non-rebated door leaf made with STILE frame technology
- vertical and horizontal stiles made of MDF board covered with GREKO, PREMIUM, ST CPL laminates or ST CPL laminate with AntiFinger coating
- vertical rails made of glulam covered with HDF and MDF boards<sup>4)</sup>
- panels made of HDF board 4 mm thick covered with GREKO, CPL or PREMIUM laminate
- optional, with extra charges: door frame extension panels and a crosshead with pilasters, pp. 155–157.
- possibility to shorten the door leaf on your own, details p. 153

## HARDWARE

- three silver 2-pin hinges with horizontal adjustment in the rebated door leaf or, for an extra charge, black ones
- two hinges (third for an extra charge) concealed in the non-rebated door leaf painted in silver color (optionally for an extra charge in black, gold or white); hinges are supplied and priced with the frame
- latch-bolt lock in rebated door leaf and magnetic (optionally latch-bolt) in non-rebated door leaf for key, patent insert, economy or with lock in silver (optionally for an extra charge in black); optionally for an extra charge magnetic lock in black, gold or white

## GLAZING

- standard: tempered milk or clear glass 4 mm and for an extra charge laminated glass VSG 221 milk or black safety glass, smooth on both sides
- possibility to change the glazing side to REVERSE (OBERVERSE is standard glazing), p. 154

## AVAILABLE SOLUTIONS (pp. 158-169)



## AVAILABLE DOOR LEAF WIDTHS

NEW

60 65 70 75 80N<sup>5)</sup> 80 85 90 95 100

### GREKO



### PREMIUM



### CPL

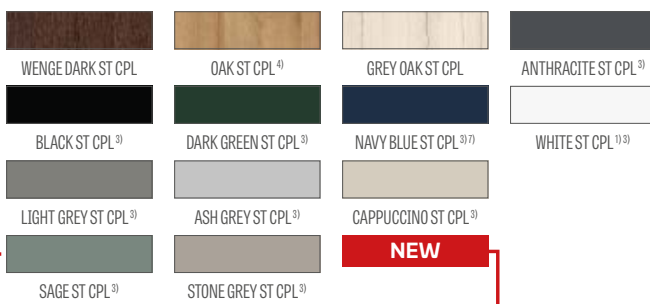

<sup>1)</sup> smooth white laminate imitating a painted surface

<sup>3)</sup> special **AntiFinger** coating reducing dirt and fingerprints

<sup>4)</sup> vertical stiles made of glulam covered with HDF and MDF boards available at extra charge for decors WHITE PREMIUM, NATUR OAK PREMIUM, GRAPHITE ASH PREMIUM, GREY MAPLE PREMIUM, OAK ST CPL

<sup>5)</sup> only for non-rebated doors

<sup>6)</sup> not available for GREKO decors

<sup>7)</sup> while stocks last

## EXTRA CHARGES

factory through drilling for handles (so-called split) ordered as a set with the door leaf

enhanced airflow trim standard or mini, ventilation undercut standard or mini (p. 153)

wood-like plastic sleeves (4 pcs.)

metal sleeves round and square (4 pcs.); finish: brushed nickel, patina, white and black

ventilation grille (only for door leaves with widths: 80, 90, 100)

rebated and non-rebated door leaf "100"

laminated VSG 221 glass, safe, smooth on both sides

metal caps for hinges in rebated door leaves

(color: brushed nickel, patina, shiny chrome, shiny brass, white and black)

change to hinges, strike plate and lock in black color for rebated door leaves

drop-down seal

change to magnetic lock in black, white or gold color for non-rebated door leaves

change to hinges and strike plate in black, white or gold for non-rebated door leaves

glulam stiles<sup>4)</sup>

standard PL2112<sup>6)</sup>

+15% to the price of the door leaf before extra charges



# BUDLEJA, POWOJNIK

REBATED AND NON-REBATED INTERIOR STILE DOORS



BUDLEJA 8 in WALNUT CLASSIC PREMIUM decor, with BELLA SLIM shiny brass handle



BUDLEJA 1



BUDLEJA 2



BUDLEJA 4



BUDLEJA 6



BUDLEJA 8



POWOJNIK 1



POWOJNIK 2



POWOJNIK 3

BUDLE JA 1 in WALNUT CLASSIC PREMIUM decor, with BELLA SLIM shiny brass handle



## DESIGN

- rebated or non-rebated door leaf made with STILE frame technology
- vertical and horizontal stiles made of MDF board covered with PREMIUM, ST CPL laminates, or ST CPL laminate with AntiFinger coating
- vertical rails made of glulam covered with HDF and MDF boards<sup>4)</sup>
- panels made of HDF board 4 mm thick covered with CPL or PREMIUM laminate (POWOJNIK)
- very wide rail, thickness 35 mm
- optional, with extra charges: door frame extension panels and a crosshead with pilasters, pp. 155-157.
- possibility to shorten the door leaf on your own, details p. 153

## HARDWARE

- three silver 2-pin hinges with horizontal adjustment in the rebated door leaf or, for an extra charge, black ones
- two hinges (third for an extra charge) concealed in the non-rebated door leaf painted in silver color (optionally for an extra charge in black, gold or white); hinges are supplied and priced with the frame
- latch-bolt lock in rebated door leaf and magnetic (optionally latch-bolt) in non-rebated door leaf for key, patent insert, economy or with lock in silver (optionally for an extra charge in black); optionally for an extra charge magnetic lock in black, gold or white

## GLAZING

- standard: tempered milk or clear glass 4 mm and for an extra charge laminated glass VSG 221 milk or black safety glass, smooth on both sides
- possibility to change the glazing side to REVERSE (OBERSE is standard glazing), p. 154

## AVAILABLE SOLUTIONS (pp. 158-169)

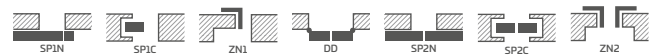

## AVAILABLE DOOR LEAF WIDTHS

**NEW**

60 65 70 75 80N<sup>5)</sup> 80 85 90 95 100

### PREMIUM

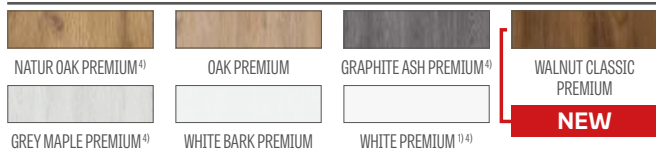

### CPL

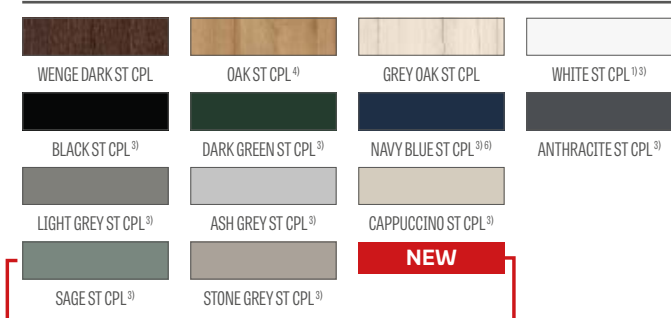

## EXTRA CHARGES

factory through drilling for handles (so-called split) ordered as a set with the door leaf

enhanced airflow trim standard or mini, ventilation undercut standard or mini (p. 153)

wood-like plastic sleeves (4 pcs.)

metal sleeves round and square (4 pcs.); finish: brushed nickel, patina, white and black

ventilation grille (only for door leaves with widths: 80, 90, 100)

rebated and non-rebated door leaf "100"

laminated VSG 221 glass, safe, smooth on both sides

metal caps for hinges in rebated door leaves

(color: brushed nickel, patina, shiny chrome, shiny brass, white and black)

change to hinges, strike plate and lock in black color for rebated door leaves

drop-down seal

change to magnetic lock in black, white or gold color for non-rebated door leaves

change to hinges and strike plate in black, white or gold for non-rebated door leaves

glulam stiles<sup>4)</sup>



Glulam stiles<sup>4)</sup>

<sup>1)</sup> smooth white laminate imitating a painted surface

<sup>3)</sup> special **AntiFinger** coating reducing dirt and fingerprints

<sup>4)</sup> vertical stiles made of glulam covered with HDF and MDF boards available at extra charge for decors WHITE PREMIUM, NATUR OAK PREMIUM, GRAPHITE ASH PREMIUM, GREY MAPLE PREMIUM, OAK ST CPL

<sup>5)</sup> only for non-rebated doors<sup>6)</sup> while stocks last



# LUKRECJA

REBATED AND NON-REBATED INTERIOR STILE DOORS



LUKRECJA 1 in NATUR OAK PREMIUM decor, with clear glazing, with BELLA SLIM shiny brass handle



LUKRECJA 1



LUKRECJA 2



LUKRECJA 3



LUKRECJA 4



LUKRECJA 5



LUKRECJA 6



LUKRECJA 7



LUKRECJA 8



LUKRECJA 9



Double-sided adhesive muntin width 25 mm  
in the color of the door leaf or black

LUKRECJA 1 in OAK ST CPL decor, with BELLA SLIM handle shiny brass



## DESIGN

- rebated or non-rebated door leaf made with STILE frame technology
- vertical and horizontal stiles made of MDF board covered with PREMIUM, ST CPL laminates, or ST CPL laminate with AntiFinger coating
- vertical rails made of glulam covered with HDF and MDF boards<sup>4)</sup>
- double-sided muntin glued to glass, width 25mm and height 12 mm
- optionally, possibility to change the muntin decor to BLACK ST CPL color regardless of the door leaf decor
- optional, with extra charges: door frame extension panels and a crosshead with pilasters, pp. 155-157.
- possibility to shorten the door leaf on your own, details p. 153

## HARDWARE

- three silver 2-pin hinges with horizontal adjustment in the rebated door leaf or, for an extra charge, black ones
- two hinges (third for an extra charge) concealed in the non-rebated door leaf painted in silver color (optionally for an extra charge in black, gold or white); hinges are supplied and priced with the frame
- latch-bolt lock in rebated door leaf and magnetic (optionally latch-bolt) in non-rebated door leaf for key, patent insert, economy or with lock in silver (optionally for an extra charge in black); optionally for an extra charge magnetic lock in black, gold or white

## GLAZING

- standard: tempered milk or clear glass 4 mm and for an extra charge laminated glass VSG 221 milk or black safety glass, smooth on both sides
- possibility to change the glazing side to REVERSE (OBERSE is standard glazing), p. 154

## AVAILABLE SOLUTIONS (pp. 158-169)

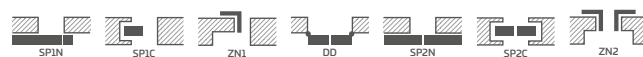

## AVAILABLE DOOR LEAF WIDTHS

NEW

60 65 70 75 80N<sup>5)</sup> 80 85 90 95 100

## EXTRA CHARGES

factory through drilling for handles (so-called split) ordered as a set with the door leaf

laminated VSG 221 glass, safe, smooth on both sides

enhanced airflow trim standard or mini, ventilation undercut standard or mini (p. 153)

wood-like plastic sleeves (4 pcs.)

metal sleeves round and square (4 pcs.); finish: brushed nickel, patina, white and black

ventilation grille (only for door leaves with widths: 80, 90, 100)

rebated and non-rebated door leaf "100"

metal caps for hinges in rebated door leaves (colours: brushed nickel, patina, glossy chrome, glossy brass, white, and black)

change to hinges, strike plate and lock in black color for rebated door leaves

drop-down seal

change to magnetic lock in black, white or gold color for non-rebated door leaves

change to hinges and strike plate in black, white or gold for non-rebated door leaves

glulam stiles<sup>4)</sup>

standard PL2112

+15% to the price of the door leaf before extra charges

## PREMIUM



## CPL

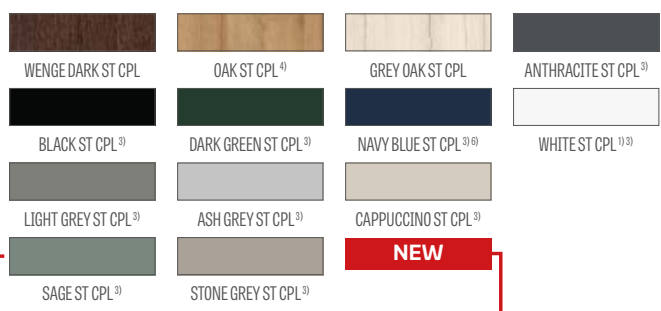

Glulam stiles<sup>4)</sup>

<sup>1)</sup> smooth white laminate imitating a painted surface

<sup>3)</sup> special **AntiFinger** coating reducing dirt and fingerprints

<sup>4)</sup> vertical stiles made of glulam covered with HDF and MDF boards available at extra charge for decors WHITE PREMIUM, NATUR OAK PREMIUM, GRAPHITE ASH PREMIUM, GREY MAPLE PREMIUM, OAK ST CPL

<sup>5)</sup> only for non-rebated doors<sup>6)</sup> while stocks last



# EPIMEDIUM

REBATED AND NON-REBATED INTERIOR STILE DOORS



EPIMEDIUM 6 in GREY ST CPL decor, with black VSG glazing, with QUANTA FIT handle black matt

WIDTH 80



EPIMEDIUM 1<sup>\*)</sup>



EPIMEDIUM 2<sup>\*)</sup>



EPIMEDIUM 3<sup>\*)</sup>



EPIMEDIUM 4<sup>\*)</sup>



EPIMEDIUM 6<sup>\*)</sup>

WIDTH 70



EPIMEDIUM 1<sup>\*)</sup>



EPIMEDIUM 2<sup>\*)</sup>



EPIMEDIUM 3<sup>\*)</sup>



EPIMEDIUM 4<sup>\*)</sup>



EPIMEDIUM 6<sup>\*)</sup>

<sup>\*)</sup> The presented photos of EPIMEDIUM doors refer only to the door leaf widths "80" and "70". In other widths, there are also significant differences in proportions of glass in relation to the vertical rails, which may affect the customer's product choice.

Graphics showing the individual widths can be found at [www.erkado.pl](http://www.erkado.pl)

EPI MEDIUM 6 in GREY ST CPL decor, with QUANTA FTI handle black matt, with black VSG glazing



## DESIGN

- rebated or non-rebated door leaf made with STILE frame technology
- vertical and horizontal stiles made of MDF board covered with GREKO, PREMIUM, ST CPL laminates or ST CPL laminate with AntiFinger coating
- vertical rails made of glulam covered with HDF and MDF boards<sup>4)</sup>
- panels made of HDF board 4 mm thick covered with GREKO, CPL or PREMIUM laminate
- narrow longitudinal rail thickness 22 mm
- optional, with extra charges: door frame extension panels and a crosshead with pilasters, pp. 155-157.
- possibility to shorten the door leaf on your own, details p. 153

## HARDWARE

- three silver 2-pin hinges with horizontal adjustment in the rebated door leaf or, for an extra charge, black ones
- two hinges (third for an extra charge) concealed in the non-rebated door leaf painted in silver color (optionally for an extra charge in black, gold or white); hinges are supplied and priced with the frame
- latch-bolt lock in rebated door leaf and magnetic (optionally latch-bolt) in non-rebated door leaf for key, patent insert, economy or with lock in silver (optionally for an extra charge in black); optionally for an extra charge magnetic lock in black, gold or white

## GLAZING

- standard: tempered milk or clear glass 4 mm, and for an extra charge laminated glass VSG 221 milk or black safety glass, smooth on both sides
- possibility to change the glazing side to REVERSE (OBERVERSE is standard glazing), p. 154
- variable glass width, depending on the width of the door leaf. See www.erkado.pl

## AVAILABLE SOLUTIONS (pp. 158-169)



## AVAILABLE DOOR LEAF WIDTHS

60 70 80N<sup>5)</sup> 80 90 100

### GREKO



### PREMIUM

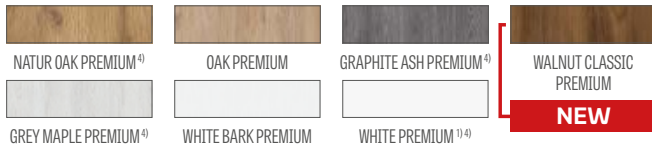

### CPL

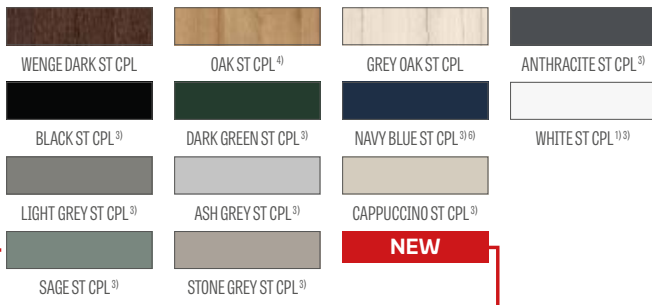

## EXTRA CHARGES

factory through drilling for handles (so-called split) ordered as a set with the door leaf

enhanced airflow trim standard or mini, ventilation undercut standard or mini (p. 153)

wood-like plastic sleeves (4 pcs.)

metal sleeves round and square (4 pcs.); finish: brushed nickel, patina, white and black

ventilation grille (only for door leaves with widths: 80, 90, 100)

rebated and non-rebated door leaf "100"

laminated VSG 221 glass, safe, smooth on both sides

metal caps for hinges on rebated door leaves (colours: brushed nickel, patina, glossy chrome, glossy brass, white, and black)

change to hinges, strike plate and lock in black color for rebated door leaves

drop-down seal

change to magnetic lock in black, white or gold color for non-rebated door leaves

change to hinges and strike plate in black, white or gold for non-rebated door leaves

glulam stiles<sup>4)</sup>

<sup>1)</sup> smooth white laminate imitating a painted surface

<sup>3)</sup> special **AntiFinger** coating reducing dirt and fingerprints

<sup>4)</sup> vertical stiles made of glulam covered with HDF and MDF boards available at extra charge for decors WHITE PREMIUM, NATUR OAK PREMIUM, GRAPHITE ASH PREMIUM, GREY MAPLE PREMIUM, OAK ST CPL

<sup>5)</sup> only for non-rebated doors <sup>6)</sup> while stocks last



# ARALIA NOLINA EWODIA

REBATED AND NON-REBATED INTERIOR STILE DOORS



NOLINA 1 in WHITE BARK PREMIUM decor, with RUMBA antibacterial handle black matt



ARALIA 1<sup>2)</sup>



NOLINA 1



EWODIA 1<sup>2)</sup>



EWODIA 2<sup>2)</sup>



EWODIA 4<sup>2)</sup>

NOLINA 1 in WHITE BARK PREMIUM decor, with TOPAZ inox handle



## DESIGN

- rebated or non-rebated door leaf made with STILE frame technology
- vertical and horizontal rails made of MDF board covered with PREMIUM laminate
- glulam stiles covered with HDF and MDF boards<sup>2)</sup>
- panels made of HDF board 16 mm thick covered with PREMIUM laminate (vertical grain)
- optional, with extra charges: door frame extension panels and a crosshead with pilasters, pp. 155–157.
- possibility to shorten the door leaf on your own, details p. 153

## HARDWARE

- three silver 2-pin hinges with horizontal adjustment in the rebated door leaf or, for an extra charge, black ones
- two hinges (third for an extra charge) concealed in the non-rebated door leaf painted in silver color (optionally for an extra charge in black, gold or white); hinges are supplied and priced with the frame
- latch-bolt lock in rebated door leaf and magnetic (optionally latch-bolt) in non-rebated door leaf for key, patent insert, economy or with lock in silver (optionally for an extra charge in black); optionally for an extra charge magnetic lock in black, gold or white

## GLAZING

- decormat milk glass 4 mm or for an extra charge laminated glass VSG 221 milk or black safety glass, smooth on both sides
- possibility to change the glazing side to REVERSE (OBVERSE is standard glazing), p. 154

## AVAILABLE SOLUTIONS (pp. 158-169)



## AVAILABLE DOOR LEAF WIDTHS



## PREMIUM



## EXTRA CHARGES

factory through drilling for handles (so-called split) ordered as a set with the door leaf

enhanced airflow trim standard or mini, ventilation undercut standard or mini (p. 153)

wood-like plastic sleeves (4 pcs.)

metal sleeves round and square (4 pcs.); finish: brushed nickel, patina, white and black

ventilation grille (only for door leaves with widths: 80, 90, 100)

rebated and non-rebated door leaf "100"

laminated VSG 221 glass, safe, smooth on both sides

metal caps for hinges in rebated door leaves

(color: brushed nickel, patina, shiny chrome, shiny brass, white and black)

change to hinges, strike plate and lock in black color for rebated door leaves

drop-down seal

change to magnetic lock in black, white or gold color for non-rebated door leaves

change to hinges and strike plate in black, white or gold for non-rebated door leaves

glulam stiles<sup>2)</sup>



Glulam stiles<sup>2)</sup>

<sup>2)</sup> glulam stiles covered with HDF and MDF boards available for an extra charge in models ARALIA 1, EWODIA 1, 2, 4 for decors NATUR OAK PREMIUM, GRAPHITE ASH PREMIUM, GREY MAPLE PREMIUM

<sup>3)</sup> only for non-rebated door leaves <sup>4)</sup> while stocks last



# JUKA

REBATED AND NON-REBATED INTERIOR STILE DOORS



JUKA 3 in OAK ST CPL decor, with TOPAZ inox handle



JUKA 1



JUKA 2



JUKA 3



JUKA 4



JUKA 5



JUKA 6



JUKA 7



JUKA 8

JUKA 1 in SAGE ST CPL decor, with BELLA SLIM handle shiny brass



**DESIGN**

- rebated or non-rebated door leaf made with STILE frame technology
- vertical and horizontal stiles made of MDF board covered with GREKO, PREMIUM, ST CPL laminates or ST CPL laminate with AntiFinger coating
- vertical rails made of glulam covered with HDF and MDF boards<sup>4)</sup>
- panels made of HDF board 4 mm thick covered with GREKO, CPL or PREMIUM laminate
- optional, with extra charges: door frame extension panels and a crosshead with pilasters, pp. 155–157.
- possibility to shorten the door leaf on your own, details p. 153

**HARDWARE**

- three silver 2-pin hinges with horizontal adjustment in the rebated door leaf or, for an extra charge, black ones
- two hinges (third for an extra charge) concealed in the non-rebated door leaf painted in silver color (optionally for an extra charge in black, gold or white); hinges are supplied and priced with the frame
- latch-bolt lock in rebated door leaf and magnetic (optionally latch-bolt) in non-rebated door leaf for key, patent insert, economy or with lock in silver (optionally for an extra charge in black); optionally for an extra charge magnetic lock in black, gold or white

**GLAZING**

- standard: tempered milk or clear glass 4 mm and for an extra charge laminated glass VSG 221 milk or black safety glass, smooth on both sides
- possibility to change the glazing side to REVERSE (OBVERSE is standard glazing), p. 154

**AVAILABLE SOLUTIONS** (pp. 158-169)

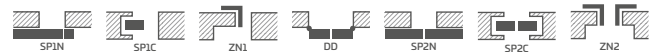

**AVAILABLE DOOR LEAF WIDTHS** NEW



**GREKO**



**PREMIUM**



**CPL**

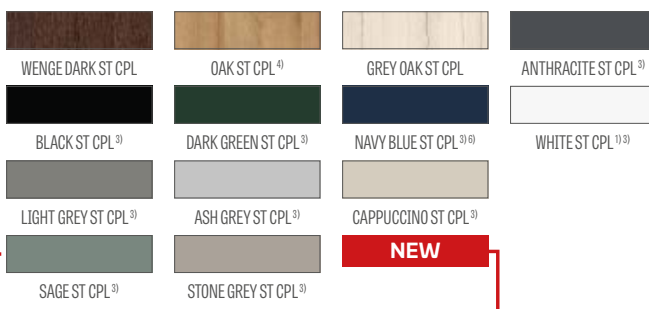

**EXTRA CHARGES**

factory through drilling for handles (so-called split) ordered as a set with the door leaf enhanced airflow trim standard or mini, ventilation undercut standard or mini (p. 153)

wood-like plastic sleeves (4 pcs.)

metal sleeves round and square (4 pcs.); finish: brushed nickel, patina, white and black

ventilation grille (only for door leaves with widths: 80, 90, 100)

rebated and non-rebated door leaf "100"

laminated VSG 221 glass, safe, smooth on both sides

metal caps for hinges in rebated door leaves (colours: brushed nickel, patina, glossy chrome, glossy brass, white, and black)

change to hinges, strike plate and lock in black color for rebated door leaves

drop-down seal

change to magnetic lock in black, white or gold color for non-rebated door leaves

change to hinges and strike plate in black, white or gold for non-rebated door leaves

glulam stiles <sup>4)</sup>

<sup>1)</sup> smooth white laminate imitating a painted surface

<sup>3)</sup> special **AntiFinger** coating reducing dirt and fingerprints

<sup>4)</sup> vertical stiles made of glulam covered with HDF and MDF boards available at extra charge for decors WHITE PREMIUM, NATUR OAK PREMIUM, GRAPHITE ASH PREMIUM, GREY MAPLE PREMIUM, OAK ST CPL

<sup>5)</sup> only for non-rebated doors <sup>6)</sup> while stocks last



# FORSYCJA

REBATED AND NON-REBATED INTERIOR STILE DOORS



FORSYCJA 1 in WHITE GREKO decor, with BELLA SLIM handle black matt



FORSYCJA 1



FORSYCJA 2



FORSYCJA 3



FORSYCJA 4



FORSYCJA 5



FORSYCJA 6



FORSYCJA 7



FORSYCJA 8

FORSYCJA 4 in WHITE GREKO decor, with CUBE handle black matt



**DESIGN**

- rebated or non-rebated door leaf made with STILE frame technology
- vertical and horizontal stiles made of MDF board covered with GREKO, PREMIUM, ST CPL laminates or ST CPL laminate with AntiFinger coating
- vertical rails made of glulam covered with HDF and MDF boards<sup>4)</sup>
- panels made of HDF board 4 mm thick covered with GREKO, CPL or PREMIUM laminate
- optional, with extra charges: door frame extension panels and a crosshead with pilasters, pp. 155–157.
- possibility to shorten the door leaf on your own, details p. 153

**HARDWARE**

- three silver 2-pin hinges with horizontal adjustment in the rebated door leaf or, for an extra charge, black ones
- two hinges (third for an extra charge) concealed in the non-rebated door leaf painted in silver color (optionally for an extra charge in black, gold or white); hinges are supplied and priced with the frame
- latch-bolt lock in rebated door leaf and magnetic (optionally latch-bolt) in non-rebated door leaf for key, patent insert, economy or with lock in silver (optionally for an extra charge in black); optionally for an extra charge magnetic lock in black, gold or white

**GLAZING**

- standard: tempered milk or clear glass 4 mm and for an extra charge laminated glass VSG 221 milk or black safety glass, smooth on both sides
- possibility to change the glazing side to REVERSE (OBERSE is standard glazing), p. 154

**AVAILABLE SOLUTIONS** (pp. 158-169)

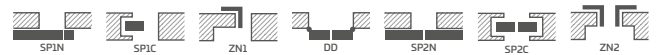

**AVAILABLE DOOR LEAF WIDTHS**

**NEW**

- 60
- 65
- 70
- 75
- 80N<sup>5)</sup>
- 80
- 85
- 90
- 95
- 100

**GREKO**



**PREMIUM**



**CPL**

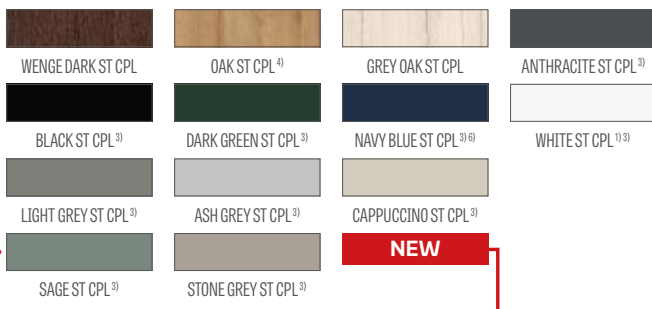

**EXTRA CHARGES**

- factory through drilling for handles (so-called split) ordered as a set with the door leaf
- enhanced airflow trim standard or mini, ventilation undercut standard or mini (p. 153)
- wood-like plastic sleeves (4 pcs.)
- metal sleeves round and square (4 pcs.); finish: brushed nickel, patina, white and black
- ventilation grille (only for door leaves with widths: 80, 90, 100)
- rebated and non-rebated door leaf "100"
- laminated VSG 221 glass, safe, smooth on both sides
- metal caps for hinges in rebated door leaves (colours: brushed nickel, patina, glossy chrome, glossy brass, white, and black)
- change to hinges, strike plate and lock in black color for rebated door leaves
- drop-down seal
- change to magnetic lock in black, white or gold color for non-rebated door leaves
- change to hinges and strike plate in black, white or gold for non-rebated door leaves
- glulam stiles<sup>4)</sup>

<sup>1)</sup> smooth white laminate imitating a painted surface  
<sup>3)</sup> special **AntiFinger** coating reducing dirt and fingerprints  
<sup>4)</sup> vertical stiles made of glulam covered with HDF and MDF boards available at extra charge for decors WHITE PREMIUM, NATUR OAK PREMIUM, GRAPHITE ASH PREMIUM, GREY MAPLE PREMIUM, OAK ST CPL  
<sup>5)</sup> only for non-rebated doors<sup>6)</sup> while stocks last



# LAWENDA

REBATED AND NON-REBATED INTERIOR STILE DOORS



LAWENDA 7 in OAK GREKO decor, with DECO handle



LAWENDA 1



LAWENDA 2



LAWENDA 3



LAWENDA 4



LAWENDA 5



LAWENDA 6



LAWENDA 7



LAWENDA 8



LAWENDA 9

LAVENDA 1 in OAK GREKO decor, with DECO handle



**DESIGN**

- rebated or non-rebated door leaf made with STILE frame technology
- vertical and horizontal stiles made of MDF board covered with GREKO, PREMIUM, ST CPL laminates or ST CPL laminate with AntiFinger coating
- vertical rails made of glulam covered with HDF and MDF boards<sup>4)</sup>
- panels made of HDF board 4 mm thick covered with GREKO, CPL or PREMIUM laminate
- optional, with extra charges: door frame extension panels and a crosshead with pilasters, pp. 155–157.
- possibility to shorten the door leaf on your own, details p. 153

**HARDWARE**

- three silver 2-pin hinges with horizontal adjustment in the rebated door leaf or, for an extra charge, black ones
- two hinges (third for an extra charge) concealed in the non-rebated door leaf painted in silver color (optionally for an extra charge in black, gold or white); hinges are supplied and priced with the frame
- latch-bolt lock in rebated door leaf and magnetic (optionally latch-bolt) in non-rebated door leaf for key, patent insert, economy or with lock in silver (optionally for an extra charge in black); optionally for an extra charge magnetic lock in black, gold or white

**GLAZING**

- standard: tempered milk or clear glass 4 mm and for an extra charge laminated glass VSG 221 milk or black safety glass, smooth on both sides
- possibility to change the glazing side to REVERSE (OBERSE is standard glazing), p. 154

**AVAILABLE SOLUTIONS** (pp. 158-169)



**AVAILABLE DOOR LEAF WIDTHS** NEW



**GREKO**



**PREMIUM**

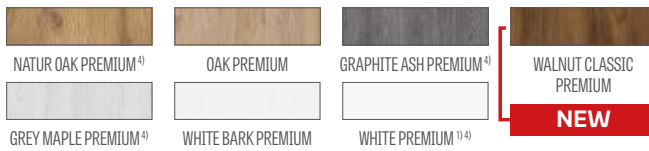

**CPL**

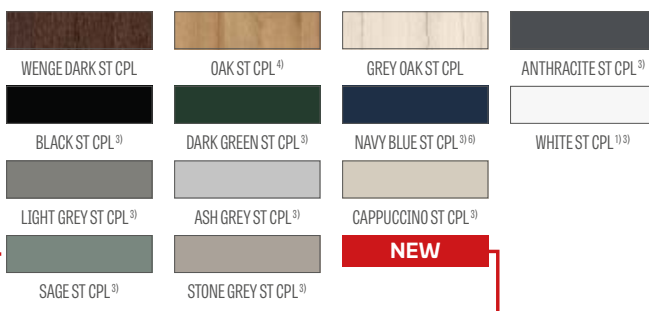

**EXTRA CHARGES**

factory through drilling for handles (so-called split) ordered as a set with the door leaf

enhanced airflow trim standard or mini, ventilation undercut standard or mini (p. 153)

wood-like plastic sleeves (4 pcs.)

metal sleeves round and square (4 pcs.); finish: brushed nickel, patina, white and black

ventilation grille (only for door leaves with widths: 80, 90, 100)

rebated and non-rebated door leaf "100"

laminated VSG 221 glass, safe, smooth on both sides

metal caps for hinges in rebated door leaves (colours: brushed nickel, patina, glossy chrome, glossy brass, white, and black)

change to hinges, strike plate and lock in black color for rebated door leaves

drop-down seal

change to magnetic lock in black, white or gold color for non-rebated door leaves

change to hinges and strike plate in black, white or gold for non-rebated door leaves

glulam stiles<sup>4)</sup>

<sup>1)</sup> smooth white laminate imitating a painted surface

<sup>3)</sup> special **AntiFinger** coating reducing dirt and fingerprints

<sup>4)</sup> vertical stiles made of glulam covered with HDF and MDF boards available at extra charge for decors WHITE PREMIUM, NATUR OAK PREMIUM, GRAPHITE ASH PREMIUM, GREY MAPLE PREMIUM, OAK ST CPL

<sup>5)</sup> only for non-rebated doors <sup>6)</sup> while stocks last



# IRYS

REBATED AND NON-REBATED INTERIOR STILE DOORS



IRYS1 in WHITE ST CPL decor, with CUBE handle black matt



IRYS1



IRYS2



IRYS3



IRYS4



IRYS5



IRYS6



IRYS7



IRYS8

IRYS 1 in GREY ST CPL decor, with QUANTA FIT handle black matt



## DESIGN

- rebated or non-rebated door leaf made with STILE frame technology
- vertical and horizontal stiles made of MDF board covered with GREKO, PREMIUM, ST CPL laminates or ST CPL laminate with AntiFinger coating
- vertical rails made of glulam covered with HDF and MDF boards<sup>4)</sup>
- panels made of HDF board 4 mm thick covered with GREKO, CPL or PREMIUM laminate
- optional, with extra charges: door frame extension panels and a crosshead with pilasters, pp. 155–157.
- possibility to shorten the door leaf on your own, details p. 153

## HARDWARE

- three silver 2-pin hinges with horizontal adjustment in the rebated door leaf or, for an extra charge, black ones
- two hinges (third for an extra charge) concealed in the non-rebated door leaf painted in silver color (optionally for an extra charge in black, gold or white); hinges are supplied and priced with the frame
- latch-bolt lock in rebated door leaf and magnetic (optionally latch-bolt) in non-rebated door leaf for key, patent insert, economy or with lock in silver (optionally for an extra charge in black); optionally for an extra charge magnetic lock in black, gold or white

## GLAZING

- standard: tempered milk or clear glass 4 mm, and for an extra charge laminated glass VSG 221 milk or black safety glass, smooth on both sides
- possibility to change the glazing side to REVERSE (OBERSE is standard glazing), p. 154

## AVAILABLE SOLUTIONS (pp. 158-169)



## AVAILABLE DOOR LEAF WIDTHS

NEW

60 65 70 75 80N<sup>5)</sup> 80 85 90 95 100

### GREKO



### PREMIUM

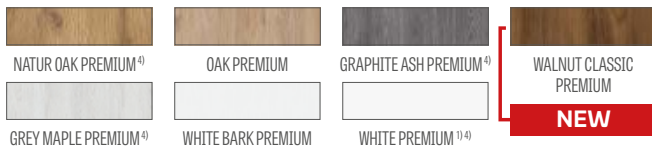

### CPL

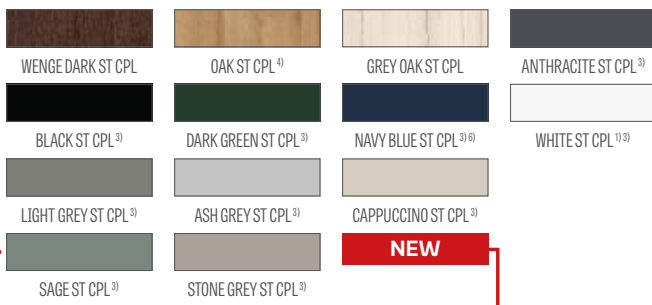

Glulam stiles<sup>4)</sup>

## EXTRA CHARGES

factory through drilling for handles (so-called split) ordered as a set with the door leaf enhanced airflow trim standard or mini, ventilation undercut standard or mini (p. 153)

wood-like plastic sleeves (4 pcs.)

metal sleeves round and square (4 pcs.); finish: brushed nickel, patina, white and black

ventilation grille (only for door leaves with widths: 80, 90, 100)

rebated and non-rebated door leaf "100"

laminated VSG 221 glass, safe, smooth on both sides

metal caps for hinges in rebated door leaves

(color: brushed nickel, patina, shiny chrome, shiny brass, white and black)

change to hinges, strike plate and lock in black color for rebated door leaves

drop-down seal

change to magnetic lock in black, white or gold color for non-rebated door leaves

change to hinges and strike plate in black, white or gold for non-rebated door leaves

glulam stiles<sup>4)</sup>

<sup>1)</sup> smooth white laminate imitating a painted surface

<sup>3)</sup> special **AntiFinger** coating reducing dirt and fingerprints

<sup>4)</sup> vertical stiles made of glulam covered with HDF and MDF boards available at extra charge for decors WHITE PREMIUM, NATUR OAK PREMIUM, GRAPHITE ASH PREMIUM, GREY MAPLE PREMIUM, OAK ST CPL

<sup>5)</sup> only for non-rebated doors<sup>6)</sup> while stocks last



# DAGLEZJA

REBATED AND NON-REBATED INTERIOR STILE DOORS



DAGLEZJA 1 in ANTHRACITE ST CPL decor, with CUBE handle brushed chrome matt



DAGLEZJA 1



DAGLEZJA 2



DAGLEZJA 3



DAGLEZJA 4



DAGLEZJA 5



DAGLEZJA 6



DAGLEZJA 7



DAGLEZJA 8

DAGLEZJA 6 in ANTHRACITE ST CPL decor, with CUBE handle brushed matt chrome



## DESIGN

- rebated or non-rebated door leaf made with STILE frame technology
- vertical and horizontal stiles made of MDF board covered with GREKO, PREMIUM, ST CPL laminates or ST CPL laminate with AntiFinger coating
- vertical rails made of glulam covered with HDF and MDF boards<sup>4)</sup>
- panels made of HDF board 4 mm thick covered with GREKO, CPL or PREMIUM laminate
- very wide crossbar
- optional, with extra charges: door frame extension panels and a crosshead with pilasters, pp. 155-157.
- possibility to shorten the door leaf on your own, details p. 153

## HARDWARE

- three silver 2-pin hinges with horizontal adjustment in the rebated door leaf or, for an extra charge, black ones
- two hinges (third for an extra charge) concealed in the non-rebated door leaf painted in silver color (optionally for an extra charge in black, gold or white); hinges are supplied and priced with the frame
- latch-bolt lock in rebated door leaf and magnetic (optionally latch-bolt) in non-rebated door leaf for key, patent insert, economy or with lock in silver (optionally for an extra charge in black); optionally for an extra charge magnetic lock in black, gold or white

## GLAZING

- standard frosted or clear glass 4 mm and for an extra charge laminated glass VSG 221 frosted or black safety glass, smooth on both sides
- possibility to change the glazing side to REVERSE (OBVERSE is standard glazing), p. 154

## AVAILABLE SOLUTIONS (pp. 158-169)

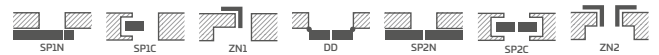

## AVAILABLE DOOR LEAF WIDTHS

**NEW**

60 65 70 75 80N<sup>5)</sup> 80 85 90 95 100

### GREKO



### PREMIUM



### CPL

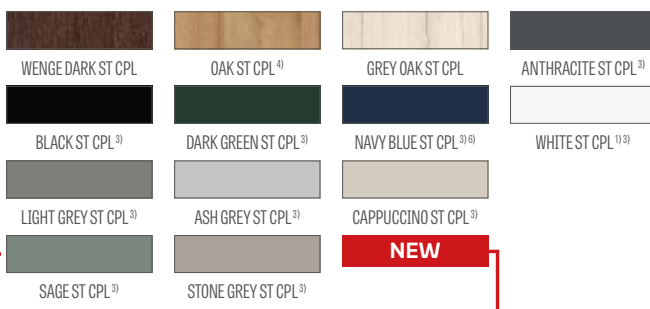

Glulam stiles<sup>4)</sup>

## EXTRA CHARGES

factory through drilling for handles (so-called split) ordered as a set with the door leaf enhanced airflow trim standard or mini, ventilation undercut standard or mini (p. 153)

wood-like plastic sleeves (4 pcs.)

metal sleeves round and square (4 pcs.); finish: brushed nickel, patina, white and black

ventilation grille (only for door leaves with widths: 80, 90, 100)

rebated and non-rebated door leaf "100"

laminated VSG 221 glass, safe, smooth on both sides

metal caps for hinges in rebated door leaves

(color: brushed nickel, patina, shiny chrome, shiny brass, white and black)

change to hinges, strike plate and lock in black color for rebated door leaves

drop-down seal

change to magnetic lock in black, white or gold color for non-rebated door leaves

change to hinges and strike plate in black, white or gold for non-rebated door leaves

glulam stiles<sup>4)</sup>

<sup>1)</sup> smooth white laminate imitating a painted surface

<sup>3)</sup> special **AntiFinger** coating reducing dirt and fingerprints

<sup>4)</sup> vertical stiles made of glulam covered with HDF and MDF boards available at extra charge for decors WHITE PREMIUM, NATUR OAK PREMIUM, GRAPHITE ASH PREMIUM, GREY MAPLE PREMIUM, OAK ST CPL

<sup>5)</sup> only for non-rebated doors<sup>6)</sup> while stocks last



# DEBECJA

REBATED AND NON-REBATED INTERIOR STILE DOORS



DEBECJA 1 in CAPPUCINO ST CPL decor, with BELLA SLIM handle shiny brass



DEBECJA 1



DEBECJA 2



DEBECJA 3



DEBECJA 4



DEBECJA 5



DEBECJA 6



DEBECJA 7

DEBECJA 7 m CAPPUCCINO ST CPL decor, with BELLA SLIM handle shiny brass



## DESIGN

- rebated or non-rebated door leaf made with STILE frame technology
- vertical and horizontal stiles made of MDF board covered with GREKO, PREMIUM, ST CPL laminates or ST CPL laminate with AntiFinger coating
- vertical rails made of glulam covered with HDF and MDF boards<sup>4)</sup>
- panels made of HDF board 4 mm thick covered with GREKO, CPL or PREMIUM laminate
- very wide crossbar
- optional, with extra charges: door frame extension panels and a crosshead with pilasters, pp. 155–157.
- possibility to shorten the door leaf on your own, details p. 153

## HARDWARE

- three silver 2-pin hinges with horizontal adjustment in the rebated door leaf or, for an extra charge, black ones
- two hinges (third for an extra charge) concealed in the non-rebated door leaf painted in silver color (optionally for an extra charge in black, gold or white); hinges are supplied and priced with the frame
- latch-bolt lock in rebated door leaf and magnetic (optionally latch-bolt) in non-rebated door leaf for key, patent insert, economy or with lock in silver (optionally for an extra charge in black); optionally for an extra charge magnetic lock in black, gold or white

## GLAZING

- standard tempered frosted or clear glass 4 mm and for an extra charge laminated glass VSG 221 frosted or black safety glass, smooth on both sides
- possibility to change the glazing side to REVERSE (OBSERVE is standard glazing), p. 154

## AVAILABLE SOLUTIONS (pp. 158-169)

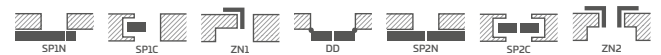

## GREKO



## PREMIUM



## CPL

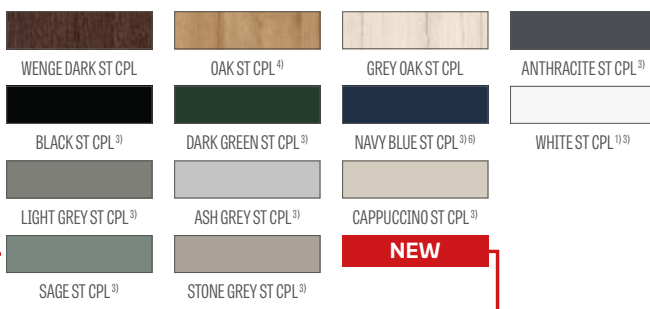

Glulam stiles<sup>4)</sup>

## AVAILABLE DOOR LEAF WIDTHS **NEW**



## EXTRA CHARGES

factory through drilling for handles (so-called split) ordered as a set with the door leaf

enhanced airflow trim standard or mini, ventilation undercut standard or mini (p. 153)

wood-like plastic sleeves (4 pcs.)

metal sleeves round and square (4 pcs.); finish: brushed nickel, patina, white and black

ventilation grille (only for door leaves with widths: 80, 90, 100)

rebated and non-rebated door leaf "100"

laminated VSG 221 glass, safe, smooth on both sides

metal caps for hinges in rebated door leaves  
(color: brushed nickel, patina, shiny chrome, shiny brass, white and black)

change to hinges, strike plate and lock in black color for rebated door leaves

drop-down seal

change to magnetic lock in black, white or gold color for non-rebated door leaves

change to hinges and strike plate in black, white or gold for non-rebated door leaves

glulam stiles<sup>4)</sup>

<sup>1)</sup> smooth white laminate imitating a painted surface

<sup>3)</sup> special **AntiFinger** coating reducing dirt and fingerprints

<sup>4)</sup> vertical stiles made of glulam covered with HDF and MDF boards available at extra charge for decors  
WHITE PREMIUM, NATUR OAK PREMIUM, GRAPHITE ASH PREMIUM, GREY MAPLE PREMIUM, OAK ST CPL

<sup>5)</sup> only for non-rebated doors<sup>6)</sup> while stocks last



# SURMIA

REBATED AND NON-REBATED INTERIOR STILE DOORS



SURMIA 1 in WENGE DARK ST CPL decor, with CUBE handle brushed matt chrome



SURMIA 1



SURMIA 2



SURMIA 3



SURMIA 4



GRAIN DIRECTIONS \*)

SURMIA 4 in WENGE DARK ST CPL decor, with CUBE handle brushed matt chrome



## DESIGN

- rebated or non-rebated door leaf made with STILE frame technology
- vertical and horizontal stiles made of MDF board covered with PREMIUM, ST CPL laminates, or ST CPL laminate with AntiFinger coating
- vertical rails made of glulam covered with HDF and MDF boards<sup>4)</sup>
- panels made of HDF board 22 mm and 4 mm thick covered with CPL or PREMIUM laminate
- very wide crossbar 35 mm thick
- optional, with extra charges: door frame extension panels and a crosshead with pilasters, pp. 155-157.
- possibility to shorten the door leaf on your own, details p. 153

## HARDWARE

- three silver 2-pin hinges with horizontal adjustment in the rebated door leaf or, for an extra charge, black ones
- two hinges (third for an extra charge) concealed in the non-rebated door leaf painted in silver color (optionally for an extra charge in black, gold or white); hinges are supplied and priced with the frame
- latch-bolt lock in rebated door leaf and magnetic (optionally latch-bolt) in non-rebated door leaf for key, patent insert, economy or with lock in silver (optionally for an extra charge in black); optionally for an extra charge magnetic lock in black, gold or white

## GLAZING

- standard tempered frosted or clear glass 4 mm and for an extra charge laminated glass VSG 221 frosted or black safety glass, smooth on both sides
- possibility to change the glazing side to REVERSE (OBVERSE is standard glazing), p. 154

## AVAILABLE SOLUTIONS (pp. 158-169)



## AVAILABLE DOOR LEAF WIDTHS

**NEW**

60 65 70 75 80N<sup>5)</sup> 80 85 90 95 100

## EXTRA CHARGES

factory through drilling for handles (so-called split) ordered as a set with the door leaf enhanced airflow trim standard or mini, ventilation undercut standard or mini (p. 153)

wood-like plastic sleeves (4 pcs.)

metal sleeves round and square (4 pcs.); finish: brushed nickel, patina, white and black

ventilation grille (only for door leaves with widths: 80, 90, 100)

rebated and non-rebated door leaf "100"

laminated VSG 221 glass, safe, smooth on both sides

metal caps for hinges in rebated door leaves

(color: brushed nickel, patina, shiny chrome, shiny brass, white and black)

change to hinges, strike plate and lock in black color for rebated door leaves

drop-down seal

change to magnetic lock in black, white or gold color for non-rebated door leaves

change to hinges and strike plate in black, white or gold for non-rebated door leaves

glulam stiles<sup>4)</sup>

### PREMIUM



### CPL

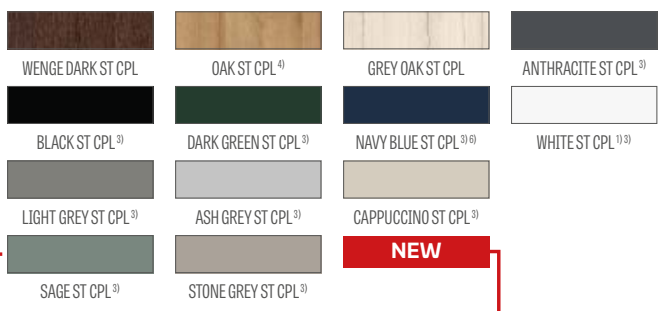

Glulam stiles<sup>4)</sup>

<sup>1)</sup> smooth white laminate imitating a painted surface

<sup>3)</sup> special **AntiFinger** coating reducing dirt and fingerprints

<sup>4)</sup> vertical stiles made of glulam covered with HDF and MDF boards available at extra charge for decors WHITE PREMIUM, NATUR OAK PREMIUM, GRAPHITE ASH PREMIUM, GREY MAPLE PREMIUM, OAK ST CPL

<sup>5)</sup> only for non-rebated doors<sup>6)</sup> while stocks last



# BERBERYS, FLOKS

REBATED AND NON-REBATED INTERIOR STILE DOORS



BERBERYS 1 in WALNUT CLASSIC PREMIUM decor, with CUBE handle brushed matt chrome



BERBERYS 1



BERBERYS 3



BERBERYS 5



BERBERYS 8



FLOKS 1



FLOKS 4



FLOKS 5



FLOKS 6

BERBERYS 1 in WALNUT CLASSIC PREMIUM decor, with CUBE handle brushed matt chrome



## DESIGN

- rebated or non-rebated door leaf made with STILE frame technology
- vertical and horizontal stiles made of MDF board covered with GREKO, PREMIUM, ST CPL laminates or ST CPL laminate with AntiFinger coating
- vertical rails made of glulam covered with HDF and MDF boards<sup>4)</sup>
- panels made of HDF board 4 mm thick covered with GREKO, CPL or PREMIUM laminate
- inserts made of brushed aluminum
- optional, with extra charges: door frame extension panels and a crosshead with pilasters, pp. 155-157.
- possibility to shorten the door leaf on your own, details p. 153

## HARDWARE

- three silver 2-pin hinges with horizontal adjustment in the rebated door leaf or, for an extra charge, black ones
- two hinges (third for an extra charge) concealed in the non-rebated door leaf painted in silver color (optionally for an extra charge in black, gold or white); hinges are supplied and priced with the frame
- latch-bolt lock in rebated door leaf and magnetic (optionally latch-bolt) in non-rebated door leaf for key, patent insert, economy or with lock in silver (optionally for an extra charge in black); optionally for an extra charge magnetic lock in black, gold or white

## GLAZING

- standard: tempered milk or clear glass 4 mm and for an extra charge laminated glass VSG 221 milk or black safety glass, smooth on both sides
- possibility to change the glazing side to REVERSE (OBVERSE is standard glazing), p. 154

## AVAILABLE SOLUTIONS (pp. 158-169)

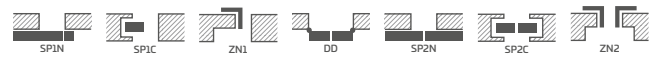

## AVAILABLE DOOR LEAF WIDTHS

NEW

60 65 70 75 80N<sup>5)</sup> 80 85 90 95 100

### GREKO



### PREMIUM



### CPL

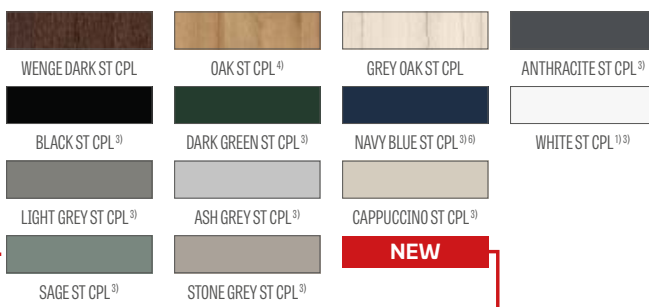

Glulam stiles<sup>4)</sup>

<sup>1)</sup> smooth white laminate imitating a painted surface

<sup>3)</sup> special **AntiFinger** coating reducing dirt and fingerprints

<sup>4)</sup> vertical stiles made of glulam covered with HDF and MDF boards available at extra charge for decors WHITE PREMIUM, NATUR OAK PREMIUM, GRAPHITE ASH PREMIUM, GREY MAPLE PREMIUM, OAK ST CPL

<sup>5)</sup> only for non-rebated doors<sup>6)</sup> while stocks last



# KROKUS

REBATED AND NON-REBATED INTERIOR STILE DOORS



KROKUS 1 in BLACK ST CPL decor, with CUBE PREMIUM handle brushed matt chrome



KROKUS 1



KROKUS 2



KROKUS 3



KROKUS 4



KROKUS 5



KROKUS 6

KROKUS-4 in BLACK ST CPL decor, with CUBE PREMIUM handle brushed matt chrome



## DESIGN

- rebated or non-rebated door leaf made with STILE frame technology
- vertical and horizontal stiles made of MDF board covered with GREKO, PREMIUM, ST CPL laminates or ST CPL laminate with AntiFinger coating
- vertical rails made of glulam covered with HDF and MDF boards<sup>4)</sup>
- panels made of HDF board 4 mm thick covered with GREKO, CPL or PREMIUM laminate
- inserts made of brushed aluminum
- optional, with extra charges: door frame extension panels and a crosshead with pilasters, pp. 155–157.
- possibility to shorten the door leaf on your own, details p. 153

## HARDWARE

- three silver 2-pin hinges with horizontal adjustment in the rebated door leaf or, for an extra charge, black ones
- two hinges (third for an extra charge) concealed in the non-rebated door leaf painted in silver color (optionally for an extra charge in black, gold or white); hinges are supplied and priced with the frame
- latch-bolt lock in rebated door leaf and magnetic (optionally latch-bolt) in non-rebated door leaf for key, patent insert, economy or with lock in silver (optionally for an extra charge in black); optionally for an extra charge magnetic lock in black, gold or white

## GLAZING

- standard: tempered milk or clear glass 4 mm and for an extra charge laminated glass VSG 221 milk or black safety glass, smooth on both sides
- possibility to change the glazing side to REVERSE (OBVERSE is standard glazing), p. 154

## AVAILABLE SOLUTIONS (pp. 158-169)



## AVAILABLE DOOR LEAF WIDTHS

**NEW**

60 65 70 75 80N<sup>5)</sup> 80 85 90 95 100

## GREKO



## PREMIUM



## CPL

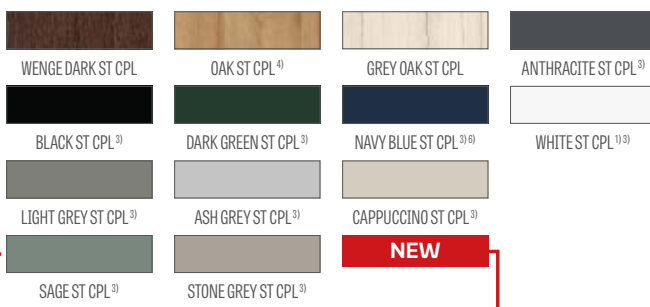

Glulam stiles<sup>4)</sup>

## EXTRA CHARGES

factory through drilling for handles (so-called split) ordered as a set with the door leaf

enhanced airflow trim standard or mini, ventilation undercut standard or mini (p. 153)

wood-like plastic sleeves (4 pcs.)

metal sleeves round and square (4 pcs.); finish: brushed nickel, patina, white and black

ventilation grille (only for door leaves with widths: 80, 90, 100)

rebated and non-rebated door leaf "100"

laminated VSG 221 glass, safe, smooth on both sides

metal caps for hinges in rebated door leaves

(color: brushed nickel, patina, shiny chrome, shiny brass, white and black)

change to hinges, strike plate and lock in black color for rebated door leaves

drop-down seal

change to magnetic lock in black, white or gold color for non-rebated door leaves

change to hinges and strike plate in black, white or gold for non-rebated door leaves

glulam stiles<sup>4)</sup>

<sup>1)</sup> smooth white laminate imitating a painted surface

<sup>3)</sup> special **AntiFinger** coating reducing dirt and fingerprints

<sup>4)</sup> vertical stiles made of glulam covered with HDF and MDF boards available at extra charge for decors WHITE PREMIUM, NATUR OAK PREMIUM, GRAPHITE ASH PREMIUM, GREY MAPLE PREMIUM, OAK ST CPL

<sup>5)</sup> only for non-rebated doors<sup>6)</sup> while stocks last



# KAMELIA

REBATED AND NON-REBATED INTERIOR STILE DOORS



KAMELIA 1 in GRAPHITE ASH PREMIUM decor, with CUBE handle brushed matt chrome



KAMELIA 1



KAMELIA 2



KAMELIA 3



KAMELIA 4



KAMELIA 5



KAMELIA 6



KAMELIA 7



KAMELIA 8

KAMELIA 1 in GRAPHITE ASH PREMIUM decor, with CUBE handle brushed matt chrome



## DESIGN

- rebated or non-rebated door leaf made with STILE frame technology
- vertical and horizontal stiles made of MDF board covered with GREKO, PREMIUM, ST CPL laminates or ST CPL laminate with AntiFinger coating
- vertical rails made of glulam covered with HDF and MDF boards<sup>4)</sup>
- panels made of HDF board 4 mm thick covered with GREKO, CPL or PREMIUM laminate
- optional, with extra charges: door frame extension panels and a crosshead with pilasters, pp. 155–157.
- possibility to shorten the door leaf on your own, details p. 153

## HARDWARE

- three silver 2-pin hinges with horizontal adjustment in the rebated door leaf or, for an extra charge, black ones
- two hinges (third for an extra charge) concealed in the non-rebated door leaf painted in silver color (optionally for an extra charge in black, gold or white); hinges are supplied and priced with the frame
- latch-bolt lock in rebated door leaf and magnetic (optionally latch-bolt) in non-rebated door leaf for key, patent insert, economy or with lock in silver (optionally for an extra charge in black); optionally for an extra charge magnetic lock in black, gold or white

## GLAZING

- standard: frosted or clear glass 4 mm, and for an extra charge laminated VSG 221 glass, frosted or black safe, smooth on both sides
- possibility to change the glazing side to REVERSE (OBERVERSE is standard glazing), p. 154

## AVAILABLE SOLUTIONS (pp. 158-169)

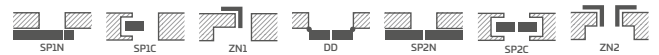

## AVAILABLE DOOR LEAF WIDTHS

**NEW**

60 65 70 75 80N<sup>5)</sup> 80 85 90 95 100

### GREKO



### PREMIUM



### CPL

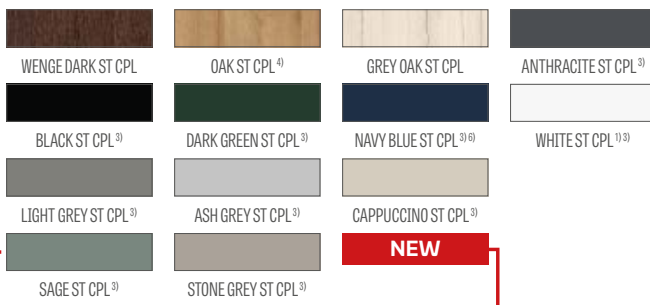

Glulam stiles<sup>4)</sup>

<sup>1)</sup> smooth white laminate imitating a painted surface

<sup>3)</sup> special **AntiFinger** coating reducing dirt and fingerprints

<sup>4)</sup> vertical stiles made of glulam covered with HDF and MDF boards available at extra charge for decors WHITE PREMIUM, NATUR OAK PREMIUM, GRAPHITE ASH PREMIUM, GREY MAPLE PREMIUM, OAK ST CPL

<sup>5)</sup> only for non-rebated doors<sup>6)</sup> while stocks last



# PETUNIA

REBATED AND NON-REBATED INTERIOR STILE DOORS



PETUNIA 1 in OAK PREMIUM decor, with CUBE handle black matt



PETUNIA 1



PETUNIA 2



PETUNIA 3



PETUNIA 4



PETUNIA 5



PETUNIA 6



PETUNIA 7



PETUNIA 8

PETUNIA 6 in OAK PREMIUM decor, with TOPAZ inox handle



## DESIGN

- rebated or non-rebated door leaf made with STILE frame technology
- vertical and horizontal stiles made of MDF board covered with GREKO, PREMIUM, ST CPL laminates or ST CPL laminate with AntiFinger coating
- vertical rails made of glulam covered with HDF and MDF boards<sup>4)</sup>
- panels made of HDF board 4 mm thick covered with GREKO, CPL or PREMIUM laminate
- optional, with extra charges: door frame extension panels and a crosshead with pilasters, pp. 155–157.
- possibility to shorten the door leaf on your own, details p. 153

## HARDWARE

- three silver 2-pin hinges with horizontal adjustment in the rebated door leaf or, for an extra charge, black ones
- two hinges (third for an extra charge) concealed in the non-rebated door leaf painted in silver color (optionally for an extra charge in black, gold or white); hinges are supplied and priced with the frame
- latch-bolt lock in rebated door leaf and magnetic (optionally latch-bolt) in non-rebated door leaf for key, patent insert, economy or with lock in silver (optionally for an extra charge in black); optionally for an extra charge magnetic lock in black, gold or white

## GLAZING

- standard: tempered milk or clear glass 4 mm and for an extra charge laminated glass VSG 221 milk or black safety glass, smooth on both sides
- possibility to change the glazing side to REVERSE (OBERSE is standard glazing), p. 154

## AVAILABLE SOLUTIONS (pp. 158-169)



## AVAILABLE DOOR LEAF WIDTHS

NEW

60 65 70 75 80N<sup>5)</sup> 80 85 90 95 100

### GREKO



### PREMIUM

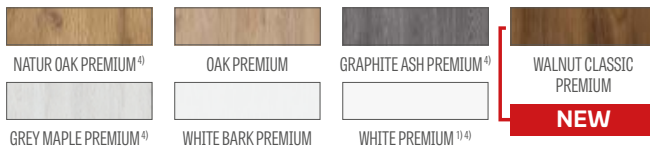

### CPL

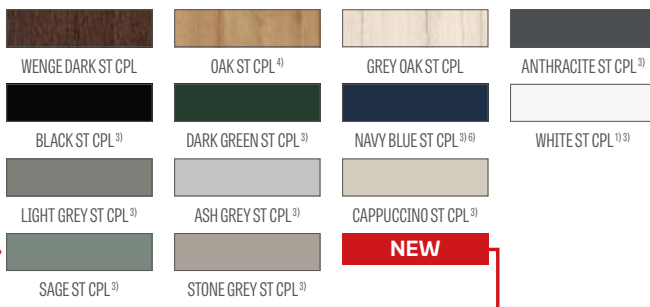

Glulam stiles<sup>4)</sup>

## EXTRA CHARGES

factory through drilling for handles (so-called split) ordered as a set with the door leaf enhanced airflow trim standard or mini, ventilation undercut standard or mini (p. 153)

wood-like plastic sleeves (4 pcs.)

metal sleeves round and square (4 pcs.); finish: brushed nickel, patina, white and black

ventilation grille (only for door leaves with widths: 80, 90, 100)

rebated and non-rebated door leaf "100"

laminated VSG 221 glass, safe, smooth on both sides

metal caps for hinges in rebated door leaves (color: brushed nickel, patina, shiny chrome, shiny brass, white and black)

change to hinges, strike plate and lock in black color for rebated door leaves

drop-down seal

change to magnetic lock in black, white or gold color for non-rebated door leaves

change to hinges and strike plate in black, white or gold for non-rebated door leaves

glulam stiles<sup>4)</sup>

<sup>1)</sup> smooth white laminate imitating a painted surface

<sup>3)</sup> special **AntiFinger** coating reducing dirt and fingerprints

<sup>4)</sup> vertical stiles made of glulam covered with HDF and MDF boards available at extra charge for decors WHITE PREMIUM, NATUR OAK PREMIUM, GRAPHITE ASH PREMIUM, GREY MAPLE PREMIUM, OAK ST CPL

<sup>5)</sup> only for non-rebated doors<sup>6)</sup> while stocks last



# AZALIA

REBATED AND NON-REBATED INTERIOR STILE DOORS



AZALIA 1 in STONE GREY ST CPL decor, with CUBE handle black matt



AZALIA 1



AZALIA 2



AZALIA 3



AZALIA 4



AZALIA 5



AZALIA 6



AZALIA 7



AZALIA 8

AZALLIA 6 in STONE GREY ST CPL decor; with CUBE handle black matt



## DESIGN

- rebated or non-rebated door leaf made with STILE frame technology
- vertical and horizontal stiles made of MDF board covered with GREKO, PREMIUM, ST CPL laminates or ST CPL laminate with AntiFinger coating
- vertical rails made of glulam covered with HDF and MDF boards<sup>4)</sup>
- panels made of HDF board 4 mm thick covered with GREKO, CPL or PREMIUM laminate
- optional, with extra charges: door frame extension panels and a crosshead with pilasters, pp. 155–157.
- possibility to shorten the door leaf on your own, details p. 153

## HARDWARE

- three silver 2-pin hinges with horizontal adjustment in the rebated door leaf or, for an extra charge, black ones
- two hinges (third for an extra charge) concealed in the non-rebated door leaf painted in silver color (optionally for an extra charge in black, gold or white); hinges are supplied and priced with the frame
- latch-bolt lock in rebated door leaf and magnetic (optionally latch-bolt) in non-rebated door leaf for key, patent insert, economy or with lock in silver (optionally for an extra charge in black); optionally for an extra charge magnetic lock in black, gold or white

## GLAZING

- standard: tempered milk or clear glass 4 mm and for an extra charge laminated glass VSG 221 milk or black safety glass, smooth on both sides
- possibility to change the glazing side to REVERSE (OBERSE is standard glazing), p. 154

## AVAILABLE SOLUTIONS (pp. 158-169)



## AVAILABLE DOOR LEAF WIDTHS

NEW

60 65 70 75 80N<sup>5)</sup> 80 85 90 95 100

### GREKO



### PREMIUM



### CPL

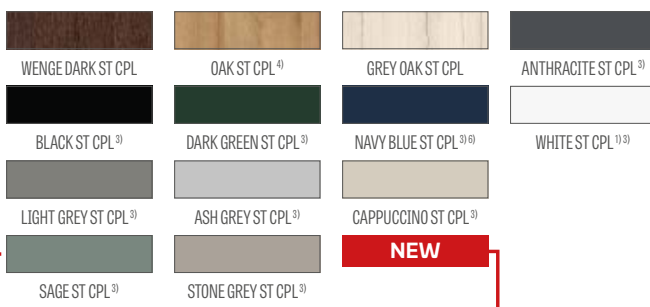

## EXTRA CHARGES

factory through drilling for handles (so-called split) ordered as a set with the door leaf enhanced airflow trim standard or mini, ventilation undercut standard or mini (p. 153)

wood-like plastic sleeves (4 pcs.)

metal sleeves round and square (4 pcs.); finish: brushed nickel, patina, white and black

ventilation grille (only for door leaves with widths: 80, 90, 100)

rebated and non-rebated door leaf "100"

laminated VSG 221 glass, safe, smooth on both sides

metal caps for hinges in rebated door leaves (color: brushed nickel, patina, shiny chrome, shiny brass, white and black)

change to hinges, strike plate and lock in black color for rebated door leaves

drop-down seal

change to magnetic lock in black, white or gold color for non-rebated door leaves

change to hinges and strike plate in black, white or gold for non-rebated door leaves

glulam stiles<sup>4)</sup>

<sup>1)</sup> smooth white laminate imitating a painted surface

<sup>3)</sup> special **AntiFinger** coating reducing dirt and fingerprints

<sup>4)</sup> vertical stiles made of glulam covered with HDF and MDF boards available at extra charge for decors WHITE PREMIUM, NATUR OAK PREMIUM, GRAPHITE ASH PREMIUM, GREY MAPLE PREMIUM, OAK ST CPL

<sup>5)</sup> only for non-rebated doors<sup>6)</sup> while stocks last



# HIACYNT

REBATED AND NON-REBATED INTERIOR STILE DOORS



HIACYNT 6 in GREY MAPLE PREMIUM decor, with QUANTA FIT handle black matt



HIACYNT 1



HIACYNT 2



HIACYNT 3



HIACYNT 4



HIACYNT 5



HIACYNT 6



HIACYNT 7



HIACYNT 8

HIACYNT 1 in GREY MAPLE PREMIUM decor, with QUANTA FIT handle black matt



## DESIGN

- rebated or non-rebated door leaf made with STILE frame technology
- vertical and horizontal stiles made of MDF board covered with GREKO, PREMIUM, ST CPL laminates or ST CPL laminate with AntiFinger coating
- vertical rails made of glulam covered with HDF and MDF boards<sup>4)</sup>
- panels made of 22 mm thick HDF board covered with GREKO, CPL or PREMIUM laminate
- optional, with extra charges: door frame extension panels and a crosshead with pilasters, pp. 155–157.
- possibility to shorten the door leaf on your own, details p. 153

## HARDWARE

- three silver 2-pin hinges with horizontal adjustment in the rebated door leaf or, for an extra charge, black ones
- two hinges (third for an extra charge) concealed in the non-rebated door leaf painted in silver color (optionally for an extra charge in black, gold or white); hinges are supplied and priced with the frame
- latch-bolt lock in rebated door leaf and magnetic (optionally latch-bolt) in non-rebated door leaf for key, patent insert, economy or with lock in silver (optionally for an extra charge in black); optionally for an extra charge magnetic lock in black, gold or white

## GLAZING

- standard: tempered milk or clear glass 4 mm and for an extra charge laminated glass VSG 221 milk or black safety glass, smooth on both sides
- possibility to change the glazing side to REVERSE (OBERVERSE is standard glazing), p. 154

## AVAILABLE SOLUTIONS (pp. 158-169)



## AVAILABLE DOOR LEAF WIDTHS

NEW

60 65 70 75 80N<sup>5)</sup> 80 85 90 95 100

### GREKO



### PREMIUM



### CPL

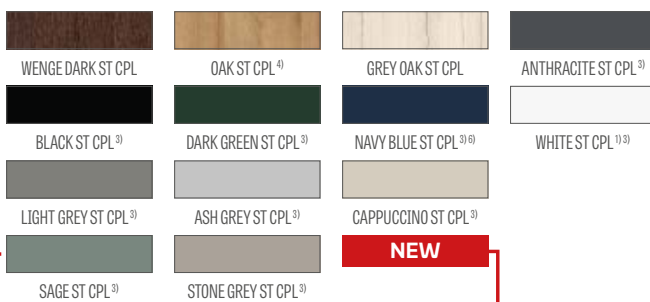

Glulam stiles<sup>4)</sup>

## EXTRA CHARGES

factory through drilling for handles (so-called split) ordered as a set with the door leaf enhanced airflow trim standard or mini, ventilation undercut standard or mini (p. 153)

wood-like plastic sleeves (4 pcs.)

metal sleeves round and square (4 pcs.); finish: brushed nickel, patina, white and black

ventilation grille (only for door leaves with widths: 80, 90, 100)

rebated and non-rebated door leaf "100"

laminated VSG 221 glass, safe, smooth on both sides

metal caps for hinges in rebated door leaf; (color: brushed nickel, patina, chrome gloss, brass gloss, white and black)

change to hinges, strike plate and lock in black color for rebated door leaves

drop-down seal

change to magnetic lock in black, white or gold color for non-rebated door leaves

change to hinges and strike plate in black, white or gold for non-rebated door leaves

glulam stiles<sup>4)</sup>

<sup>1)</sup> smooth white laminate imitating a painted surface

<sup>3)</sup> special **AntiFinger** coating reducing dirt and fingerprints

<sup>4)</sup> vertical stiles made of glulam covered with HDF and MDF boards available at extra charge for decors WHITE PREMIUM, NATUR OAK PREMIUM, GRAPHITE ASH PREMIUM, GREY MAPLE PREMIUM, OAK ST CPL

<sup>5)</sup> only for non-rebated doors<sup>6)</sup> while stocks last



# FRAGI

INTERIOR DOOR LEAVES FRAME STYLE REBATED



FRAGI 19 POINT **NEW** in BLACK ST CPL decor, with CUBE PREMIUM handle brushed chrome matt



FRAGI 4  
DECORMAT



FRAGI 5  
TRANSPARENT



FRAGI 7  
DECORMAT GRAPHITE



FRAGI 9



FRAGI 10



FRAGI 15  
VSG/ESG milky



FRAGI 16  
VSG/ESG black



FRAGI 17  
SMOKY GRAPHITE

FRAGI 18 RELIEF, in BLACK ST CPL decor, with CUBE PREMIUM handle brushed matt chrome

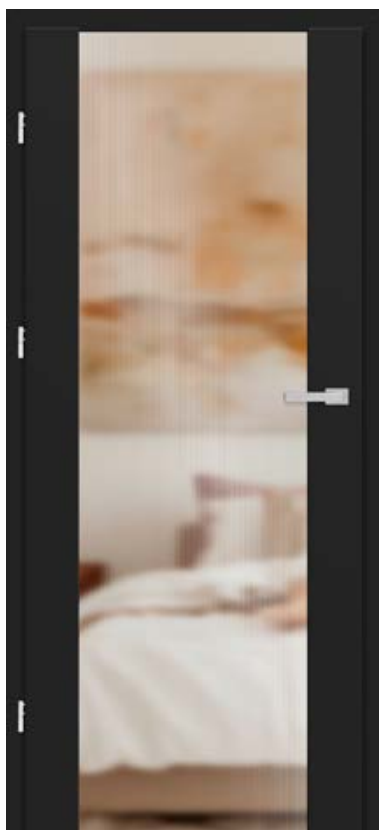

**NEW**

## DESIGN

- rebated or non-rebated door leaf **NEW** (except FRAGI 9 and 10) made in the STILE frame technology
- vertical and horizontal rails made of MDF board covered with GREKO, PREMIUM, ST CPL laminates or ST CPL laminate with AntiFinger coating
- vertical rails made of glulam covered with HDF and MDF boards<sup>3)</sup>
- for non-rebated door leaves, due to the glass being set back at the top, it does not adhere to the gasket (a technological gap remains)
- optionally, for an extra charge, door frame extension panels as well as crosshead with pilasters pp. 155-157

## HARDWARE

- three silver 2-pin hinges with horizontal adjustment in the rebated door leaf or, for an extra charge, black ones
- two hinges (third available for an extra charge) concealed in the non-rebated door leaf painted in silver color (optionally for an extra charge in black, gold or white); hinges are supplied and priced with the frame
- latch-bolt lock in rebated door leaf and magnetic (optionally latch-bolt) in non-rebated door leaf for key, patent insert, economy or with lock in silver (optionally for an extra charge in black); optionally for an extra charge magnetic lock in black, gold or white

## GLAZING

- 8 mm toughened glass or toughened and laminated glass VSG/ESG 441, frosted or black pane safe, smooth on both sides (models FRAGI 15 and FRAGI 16), smooth glass colored in mass (FRAGI 17) **NEW** or decorative toughened glass 8 mm relief (FRAGI 18) and point (FRAGI 19) **NEW**. Relief and point glass is smooth on one side.
- possibility to change the glazing side to REVERSE (OBVERSE is standard glazing), p. 154

## GREKO



## PREMIUM



## CPL

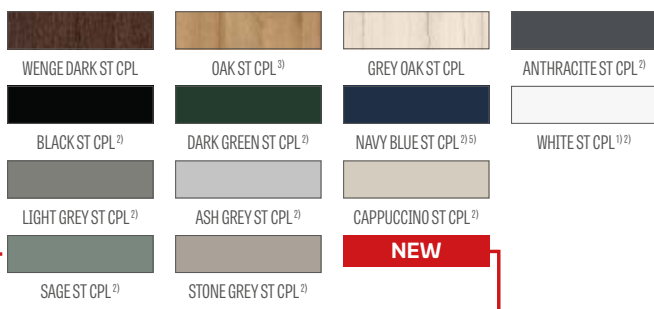

## AVAILABLE SOLUTIONS (pp. 155-157)



## AVAILABLE DOOR LEAF WIDTHS



## EXTRA CHARGES

factory through drilling for handles (so-called split) ordered as a set with the door leaf

ventilation undercut

metal caps for hinges in rebated door leaves  
(color: brushed nickel, patina, shiny chrome, shiny brass, white and black)

change to hinges, strike plate and lock in black color for rebated door leaves

replacement with a magnetic lock in black, white or gold for non-rebated door leaves

replacement with hinges and strike plate in black, white or gold for non-rebated door leaves

glulam stiles<sup>3)</sup>



Glulam stiles<sup>3)</sup>

<sup>1)</sup> smooth white laminate imitating a painted surface

<sup>2)</sup> special **AntiFinger** coating limiting dirt and fingerprints

<sup>3)</sup> vertical stiles made of glulam covered with HDF and MDF boards available at extra charge for decors WHITE PREMIUM, NATUR OAK PREMIUM, GRAPHITE ASH PREMIUM, GREY MAPLE PREMIUM, OAK ST CPL

<sup>4)</sup> only for non-rebated door leaves <sup>5)</sup> while stocks last

# LOFT BASIC



LOFT BASIC 2 in black color; transparent toughened glass.



**DESIGN**

- doors made of steel profiles, glazed, with steel muntins with a width of 20 mm and thickness of 2 mm glued on both sides to the glass pane
- the door leaf and transom frame made of powder-coated steel profiles as standard in BLACK STR and WHITE STR color, and for an extra charge in colors from the RAL STR palette
- possibility to order doors in standard dimensions (table p. 66) with side transoms made to size in widths from 200 to 1000 mm every 3 mm and heights from 1900 to 2200 mm every 3 mm (transom variants p. 66)
- the minimum height of the top sidelight is 200 mm, the maximum is 1000 mm; possibility to order custom size every 3 mm
- possibility to order doors to size in the width range from "70" to "100" every 3 mm and height from 1900 mm to 2200 mm every 3 mm (only variant H and D)
- when changing the dimensions of LOFT BASIC models, the arrangement of muntins changes proportionally with the increase in width and height
- maximum door height with top sidelight 3000 mm, maximum width of side sidelights 1000 mm
- profiles painted with powder coating technology; all colours have a fine STR texture, which creates a coating that limits dirt and fingerprints
- the arrangement of muntins varies depending on the dimensions (details in the B2B panel)
- clip-on square (at extra charge) to be installed by the customer, dimensions 15 x 15 x 1.5 mm, length 3 m, available in STANDARD colours and, at extra charge, in RAL colours

**HARDWARE**

- three welded steel hinges
- magnetic lock
- standard handle DIVA FIT or pull handle

**GLAZING**

- standard clear tempered glass 6 mm
- for an extra charge: laminated VSG milky glass 6 mm, dark grey 6 mm, smoked graphite 6 mm, decorative glass relief 6 mm and point 8 mm; decorative glasses have texture on one side (OBERSE), and are smooth on the other side (REVERSE); possibility to change the glazing side to REVERSE (OBERSE is standard).

**AVAILABLE DOOR LEAF WIDTHS**



**AVAILABLE SOLUTIONS**

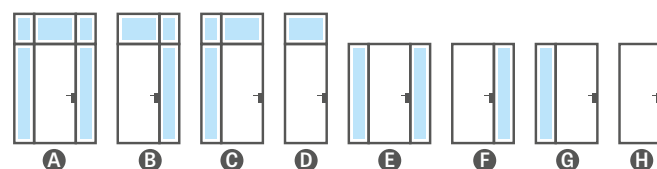

**EXTRA CHARGES**

- profiles painted in STR structure in RAL 5002, 6005, 7006, 7016, 7024, 7032, 8017, 9007, 9010 colors + 15%
- smoked graphite glass 6 mm
- dark grey glass 6 mm
- relief glass 6 mm
- point glass 8 mm
- VSG milky glass 6 mm
- door with BELLA SLIM handle, black matt
- 5 mm or 10 mm door leaf enhanced airflow trim<sup>1)</sup>
- clip-on square 15x15x1.5 mm, length 3 m, BLACK STR or WHITE STR
- cylinder (three keys) black or silver

**POWDER COATING**



**RAL STR (at extra charge)**



<sup>1)</sup> the clearance under the entire width of the door leaf is 9 mm as standard, with a recovery cut it will be 14 mm or 19 mm respectively

<sup>2)</sup> transom with an area below 0.7 m<sup>2</sup> – price as for a 0.7 m<sup>2</sup> sidelights

# LOFT CLASSIC



LOFT CLASSIC 2 in black color, clear tempered glass.



**DESIGN**

- doors made of steel profiles, glazed, with steel muntins with a width of 20 mm and thickness of 2 mm glued on both sides to the glass pane
- the door leaf and transom frame made of powder-coated steel profiles as standard in BLACK STR and WHITE STR color, and for an extra charge in colors from the RAL STR palette
- possibility to order doors in standard dimensions (table p. 66) with side transoms made to size in widths from 200 to 1000 mm every 3 mm and heights from 1900 to 2200 mm every 3 mm (transom variants p. 66)
- the minimum height of the top sidelight is 200 mm, the maximum is 1000 mm; possibility to order custom size every 3 mm
- possibility to order doors to size in the width range from "70" to "100" every 3 mm and height from 1900 mm to 2200 mm every 3 mm (only variant H and D)
- when changing the dimensions of LOFT CLASSIC models, the arrangement of muntins changes proportionally with the increase in width and height
- maximum door height with top sidelight 3000 mm, maximum width of side sidelights 1000 mm
- profiles painted with powder coating technology; all colours have a fine STR texture, which creates a coating that limits dirt and fingerprints
- the arrangement of muntins varies depending on the dimensions (details in the B2B panel)
- clip-on square (at extra charge) to be installed by the customer, dimensions 15 x 15 x 1.5 mm, length 3 m, available in STANDARD colours and, at extra charge, in RAL colours

**HARDWARE**

- three welded steel hinges
- magnetic lock
- standard handle DIVA FIT or pull handle

**GLAZING**

- standard clear tempered glass 6 mm
- for an extra charge: laminated VSG milky glass 6 mm, dark grey 6 mm, smoked graphite 6 mm, decorative glass relief 6 mm and point 8 mm; decorative glasses have texture on one side (OBSERVE), and are smooth on the other side (REVERSE); possibility to change the glazing side to REVERSE (OBSERVE is standard).

**AVAILABLE DOOR LEAF WIDTHS**



**AVAILABLE SOLUTIONS**

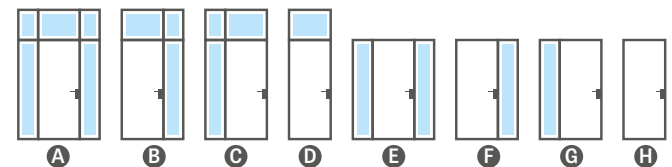

**EXTRA CHARGES**

- profiles painted in STR structure in RAL 5002, 6005, 7006, 7016, 7024, 7032, 8017, 9007, 9010 colors + 15%
- smoked graphite glass 6 mm
- dark grey glass 6 mm
- relief glass 6 mm
- point glass 8 mm
- VSG milky glass 6 mm
- door with BELLA SLIM handle, black matt
- 5 mm or 10 mm door leaf enhanced airflow trim<sup>1)</sup>
- clip-on square 15x15x1.5 mm, length 3 m, BLACK STR or WHITE STR
- cylinder (three keys) black or silver

**POWDER COATING**



**RAL STR (at extra charge)**



<sup>1)</sup> the clearance under the entire width of the door leaf is 9 mm as standard, with a recovery cut it will be 14 mm or 19 mm respectively  
<sup>2)</sup> transom with an area below 0.7 m<sup>2</sup> – price as for a 0.7 m<sup>2</sup> sidelights

# LOFT ART



LOFT ART 1 in black color, clear tempered glass.



LOFT ART 1



LOFT ART 2

**POWDER COATING**



**RAL STR (at extra charge)**



**DESIGN**

- doors made of steel profiles, glazed, with steel muntins with a width of 20 mm and thickness of 2 mm glued on both sides to the glass pane
- the door leaf and transom frame made of powder-coated steel profiles as standard in BLACK STR and WHITE STR color, and for an extra charge in colors from the RAL STR palette
- possibility to order doors in standard dimensions (table p. 66) with side transoms made to size in widths from 200 to 1000 mm every 3 mm and heights from 1900 to 2200 mm every 3 mm (transom variants p. 66)
- the minimum height of the top sidelight is 200 mm, the maximum is 1000 mm; possibility to order custom size every 3 mm
- possibility to order doors to size in the width range from "70" to "100" every 3 mm and height from 1900 mm to 2200 mm every 3 mm (only variant H and D)
- when changing the dimensions of LOFT ART models, the area between the muntin above the handle and the top one changes in height, and the area between the outermost vertical muntins changes in width
- maximum door height with top sidelight 3000 mm, maximum width of side sidelights 1000 mm
- profiles painted with powder coating technology; all colours have a fine STR texture, which creates a coating that limits dirt and fingerprints
- the arrangement of muntins varies depending on the dimensions (details in the B2B panel)
- clip-on square (at extra charge) to be installed by the customer, dimensions 15 x 15 x 1.5 mm, length 3 m, available in STANDARD colours and, at extra charge, in RAL colours

**HARDWARE**

- three welded steel hinges
- magnetic lock
- standard handle DIVA FIT or pull handle

**GLAZING**

- standard clear tempered glass 6 mm
- for an extra charge: laminated VSG milky glass 6 mm, dark grey 6 mm, smoked graphite 6 mm, decorative glass relief 6 mm and point 8 mm; decorative glasses have texture on one side (OBVERSE), and are smooth on the other side (REVERSE); possibility to change the glazing side to REVERSE (OBVERSE is standard).

**AVAILABLE DOOR LEAF WIDTHS**



**AVAILABLE SOLUTIONS**

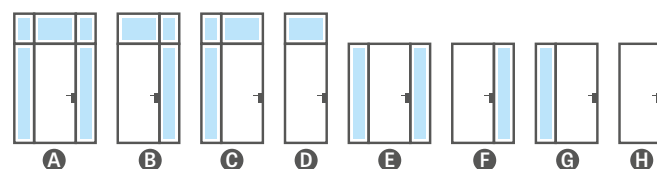

**EXTRA CHARGES**

profiles painted in STR structure in RAL 5002, 6005, 7006, 7016, 7024, 7032, 8017, 9007, 9010 colors + 15%

smoked graphite glass 6 mm

dark grey glass 6 mm

relief glass 6 mm

point glass 8 mm

VSG milky glass 6 mm

door with BELLA SLIM handle, black matt

5 mm or 10 mm door leaf enhanced airflow trim<sup>1)</sup>

clip-on square 15x15x1.5 mm, length 3 m, BLACK STR or WHITE STR

cylinder (three keys) black or silver

<sup>1)</sup> the clearance under the entire width of the door leaf is 9 mm as standard, with a recovery cut it will be 14 mm or 19 mm respectively

<sup>2)</sup> transom with an area below 0.7 m<sup>2</sup> – price as for a 0.7 m<sup>2</sup> sidelights



# LOFT

INTERNAL STEEL DOOR LEAVES

## STANDARD DOOR DIMENSIONS

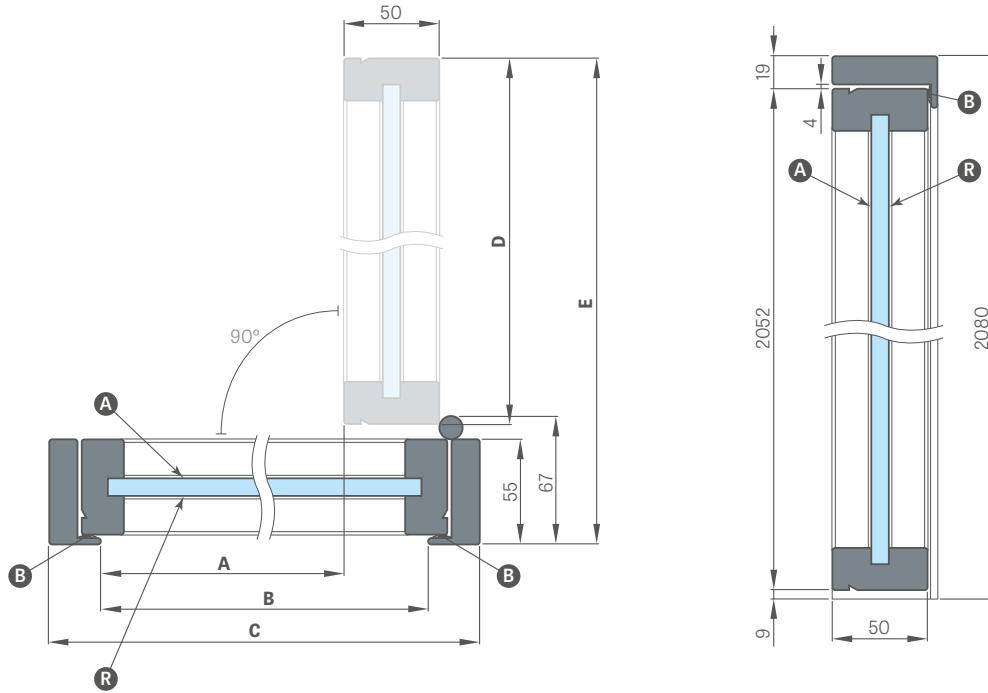

Door width	Clear opening	Frame opening	Frame width	Door leaf width	Door opening range with frame
	A	B	C	D	E
70	702	746	800	762	826
80	802	846	900	862	926
90	902	946	1000	962	1026
100	1002	1046	1100	1062	1126

- A** - glazing, OBVERSE side
- R** - glazing, REVERSE side
- B** - rubber gasket

## AVAILABLE SOLUTIONS

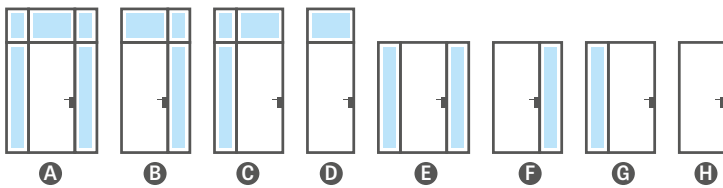

## HANDLE and GRIP



DIVA FIT handle  
matt black square  
(as standard)

BELLA SLIM handle  
matt black square  
(at extra charge)

steel grip  
painted in the color  
of the door

## AVAILABLE TYPES OF GLAZING

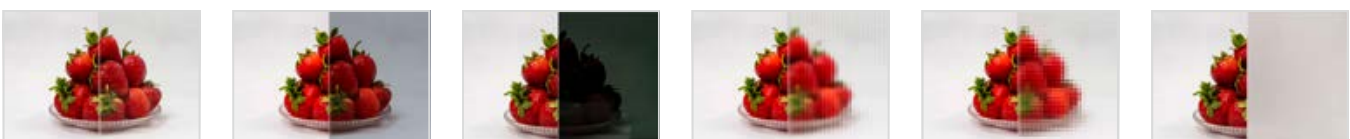

CLEAR GLASS

SMOKED GRAPHITE

DARK GREY

RELIEF GLASS

POINT GLASS

VSG MILKY

# LOFT

INTERNAL STEEL DOOR LEAVES



LOFT ART 1 DOUBLE-LEAF DOOR in black color, transparent tempered glass.



# GRAF GLASS DOORS

INTERNAL GLASS DOOR LEAVES



GRAF 68 with decorative relief glazing, with frame in BLACK ST CPL decor

# GRAF GLASS DOORS

INTERNAL GLASS DOOR LEAVES



GRAF 35

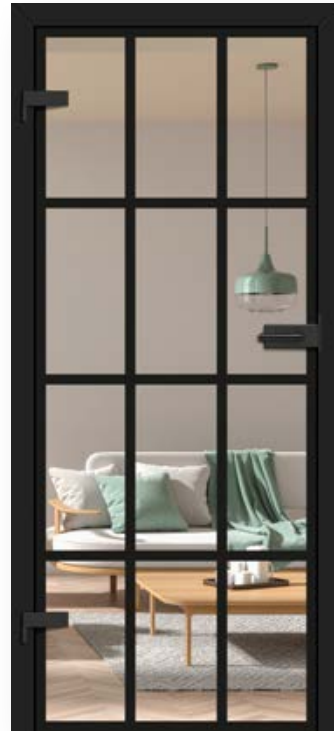

GRAF 36

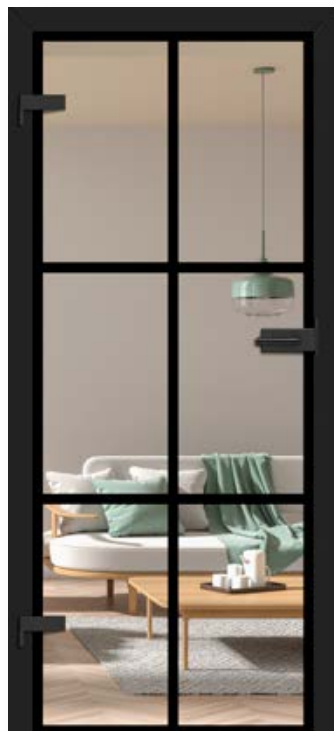

GRAF 61



GRAF 62

ILLUSTRATION OF GLAZING TRANSPARENCY on p. 154

# GRAF GLASS DOORS

INTERNAL GLASS DOOR LEAVES



GRAF 68  
RELIEF glass



GRAF 69  
POINT glass



ILLUSTRATION OF GLAZING TRANSPARENCY on p. 154

## DESIGN

- 8 mm tempered glass with or without external applications, 8 mm Antisol glass colored in mass (GRAF 26 and 67 **NEW**), laminated and tempered glass VSG/ESG (GRAF 65, 66) or for an extra charge, laminated and tempered clear glass VSG/ESG with an internal application in black for GRAF 34, 37, 63, 33, 36, 61 or white
- possibility to change the glazing side to REVERSE (OBSERVE standard glazing)
- depending on the model pattern, frosted or clear glass with patterns painted in black or white
- the width (thickness) of the line in model GRAF 35, 36, 38, 39, 61, 62 is 30 mm
- optionally, for an extra charge, door frame extension panels as well as crosshead with pilasters pp. 155-157
- available model GRAF 66 frosted VSG/ESG glass **NEW**
- models 33, 34, 36, 37, 39, 61, 63 available with smoked graphite glass
- models GRAF 68 RELIEF **NEW** and GRAF 69 POINT **NEW** decorative tempered glass 8 mm. Relief and point glass is smooth on one side.

## FIXED AND ADJUSTABLE DOOR FRAME

- prices of adjustable and fixed frames for rebated doors pp. 184-187
- no possibility to use an electric strike
- in frames for glass panes, a hinge with a pin of 10 mm is used
- in the adjustable and fixed frame, it is possible to change the strike plate (for an extra charge) to black or white powder-coated
- FOR GRAF GLASS DOOR LEAVES, ONLY REBATED FRAMES ARE AVAILABLE IN ALL AVAILABLE DECORS, STEEL FRAMES (NOT AVAILABLE WITH VERTICAL HINGE OPTION) AND UV-LACQUERED FRAME**

**NOTE:** The expanded collection of glass doors and the variety of existing models can be found on our website [www.erkado.pl](http://www.erkado.pl). The models available there can also be ordered via the B2B panel.

## EXTRA CHARGES

clear VSG/ESG glass with internal application in color black<sup>3)</sup> (models GRAF 33, 36, 39, 61) or white (models 34, 67, 63)

smoked graphite glass (models GRAF 33, 36, 39, 61)

rail door closer in colors: silver, black

door leaf "90"

door leaf "100" and "110"<sup>2)</sup> **NEW** (three hinges used as standard)

ventilation undercut

black or white strike plate

vertical hinges **NEW**

## AVAILABLE DOOR LEAF WIDTHS

60 70 80 90, 100, 110 (for an extra charge)



See more at [www.erkado.pl](http://www.erkado.pl)

## METAL-BUD HARDWARE stainless steel, black, white (available shapes: oval or rectangle)

**Metal-Bud**



TYPE OF FITTINGS	TWO HINGES		THREE HINGES	
	stainless steel	color black / white	stainless steel	color black / white
SET 1A OVAL (handle with economy lock + hinges for 10 mm pin)				
SET 2A OVAL (handle with key lock + hinges for 10 mm pin)				
SET 3A OVAL (handle with cylinder lock + hinges for 10 mm pin)				
SET 4AZ OVAL EXTERNAL (handle + lock with bolt + hinges for 10 mm pin) <sup>1)</sup>				
SET 4AW OVAL INTERNAL (handle + lock with bolt + hinges for 10 mm pin) <sup>1)</sup>				
SET 1B RECTANGLE SLIM (handle with economy lock + hinges for 10 mm pin)				
SET 2B RECTANGLE SLIM (handle with key lock + hinges for 10 mm pin)				
SET 3B RECTANGLE SLIM (handle with cylinder lock + hinges for 10 mm pin)				
SET 4BZ RECTANGLE SLIM EXTERNAL (handle + lock with latch + hinges for 10 mm pin) <sup>1)</sup>				
SET 4BW RECTANGLE SLIM INTERNAL (handle + lock with latch + hinges for 10 mm pin) <sup>1)</sup>				
patent cylinder 31/17				
patent cylinder with knob 31G/17 on the external side or 27/21G on the internal side <sup>1)</sup>				

<sup>1)</sup> detailed description of bathroom hardware selection (lock with latch) p. 152

<sup>2)</sup> available for models GRAF 8, 9, 11, 65, 66, 68, 69

<sup>3)</sup> with VSG/ESG glass, two laminated glass panes are visible from the edge



# LAMELLAS

WALL-MOUNTED



Wall lamellas with decorative strip in OAK ST CPL finish, with adapter in BLACK ST CPL finish and skirting strip in OAK ST CPL finish.  
BALDUR 1 door in OAK ST CPL finish, with black VSG glazing

Decorative lamellas are mounted on the wall as a decorative element and at the same time improve the acoustics in the room.

Installation is possible in several ways – the decorative strip can be mounted to the wall using only the mounting strip or by using adapters that serve as a base for the panels.

Decorative lamellas are available in PREMIUM and ST CPL laminates, which can be combined in selected configurations.



composition of decorative lamellas with skirting strip in OAK ST CPL finish



components of wall lamellas

## DECORATIVE STRIP

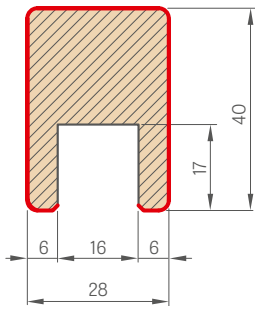

## MOUNTING STRIP

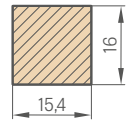

## END STRIP

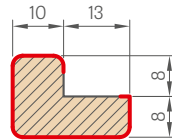

## ADAPTER

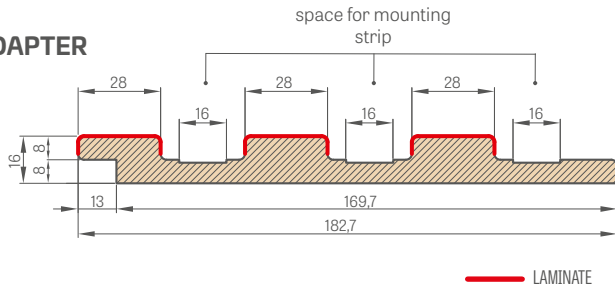

adapter, length 2750 mm
decorative strip (including mounting strip) length 2750 mm
end strip, length 2750 mm
self-adhesive cap masking the cut of the decorative strip

Individual elements of the decorative lamellas system are in a commercial length of 2750 mm, however, each product has a production length of 2800 mm and is delivered in this length, where 25 mm per side is a margin for easy self-cutting before installation, as well as a reserve in case of transport damage.

Wall lamellas can also be installed without an adapter, directly to the wall using only the mounting strip onto which the decorative strip is mounted.

The decorative strip (including the mounting strip) can only be purchased in quantities of three pieces, e.g. 3 pcs, 6 pcs, 9 pcs, etc.

Caps are available in all finishes and are used to mask the cut of the decorative strip. The caps have a self-adhesive surface on one side.

adapter – quantity in package 1 piece

end strip – quantity in package 3 pcs

decorative strip + mounting strip – quantity in package 3 pcs + 3 pcs

## DECORATIVE LAMELLAS

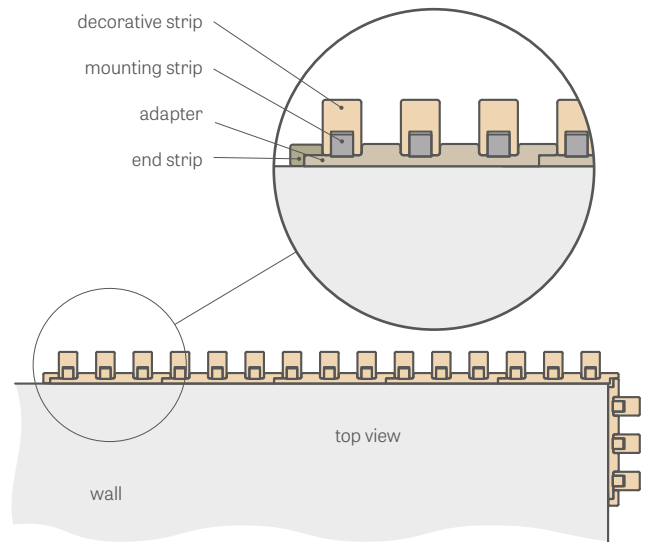

installation video  
variant with adapter:  
<https://youtu.be/p3I7u3cWMmg>



installation video  
variant without adapter:  
<https://youtu.be/fFa5afWWFOM>



## PREMIUM

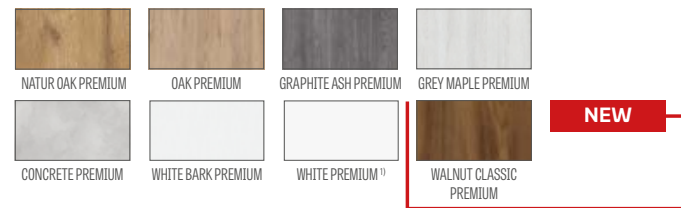

## CPL



# SKIRTING STRIPS

## SKIRTING BOARD

- length 2.40 m
- laminated
- lacquered
- The skirting board is made of moisture-resistant MDF board. Available: UV lacquer UV, laminates: GREKO, ST CPL, PREMIUM, and in primer laminate for painting..
- Installation method - gluing to the wall

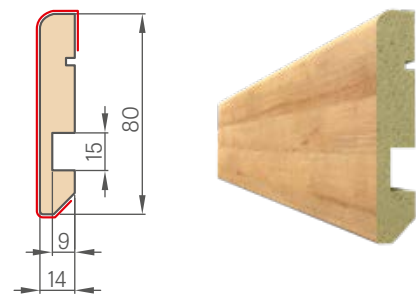

<sup>1)</sup> smooth white laminate imitating a painted surface

<sup>2)</sup> special **AntiFinger** coating limiting dirt and fingerprints



# WERBENA

LACQUERED DOOR LEAVES, REBATED, NON-REBATED AND REVERSIBLE



WERBENA 3 WHITE TITANIUM UV with QUANTA FIT handle, black matt



WERBENA 1



WERBENA 2



WERBENA 3

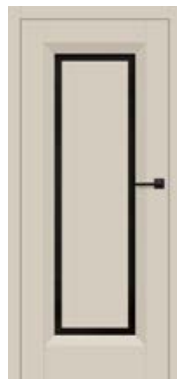

WERBENA 4



WERBENA 5

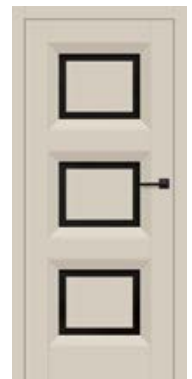

WERBENA 6



WERBENA 7



WERBENA 8



WERBENA 9

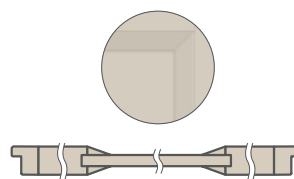

WERBENA 1, 2, 3  
beveled strip at 16 mm panel

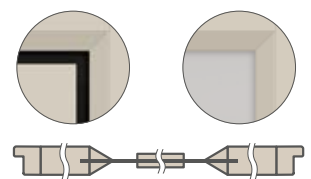

WERBENA 4, 5, 6, 7, 8, 9  
deep beveled strip by the glass



WERBENA 7 WHITE TITANIUM UV with QUANTA FIT handle, black matt



**DESIGN**

- rebated, non-rebated, or for an extra charge, reversible door leaf made with STILE technology
- vertical and horizontal rails made of MDF board, covered with laminate and painted with durable UV lacquer UV
- optionally, for an extra charge, vertical rails made of glulam covered with HDF and MDF boards
- WERBENA 1, 2, 3 - panels made of 16 mm thick MDF board framed with a beveled strip;
- WERBENA 4, 5, 6 - panels made of 3 mm thick moisture-resistant HDF board glued on both sides to glass. The edge of the panel is in the color of the door leaf.
- transparency width between the beveled strip and the glued panel 40 mm
- optional, with extra charges: door frame extension panels and a crosshead with pilasters, pp. 155-157.
- possibility to shorten the door leaf on your own, details p. 153

**FINISH**

- door leaves and frames painted with water-based lacquer cured with UV technology, which provides high resistance to demanding usage conditions

**HARDWARE**

- three silver 2-pin hinges with horizontal adjustment in the rebated door leaf or, for an extra charge, black ones
- two hinges (third for an extra charge) concealed in the non-rebated door leaf painted in silver color (optionally for an extra charge in black, gold or white); hinges are supplied and priced with the frame
- latch-bolt lock in the rebated door leaf and magnetic (optionally latch-bolt) in the non-rebated door leaf: for key, patent insert, economy or with a lock in silver color (for an extra charge in black); optionally, for an extra charge, magnetic lock in black, gold, or white color

**GLAZING**

- standard: frosted or clear tempered glass 4 mm and for an extra charge laminated glass VSG 221 frosted or black safety, smooth on both sides or decorative tempered glass 4 mm relief and point **NEW** (WERBENA 7, 8, 9). Relief and point glass is smooth on one side.
- possibility to change the glazing side to REVERSE (OBVERSE is standard glazing), p. 154

**EXTRA CHARGES**

- factory through drilling for handles (so-called split) ordered as a set with the door leaf
- reversible door leaf
- enhanced airflow trim standard or mini, ventilation undercut standard or mini (p. 153)
- rebated and non-rebated door leaf "100"
- metal caps for hinges in rebated door leaves (colours: brushed nickel, patina, glossy chrome, glossy brass, white, and black)
- change to hinges, strike plate and lock in black color for rebated door leaves
- laminated glass VSG 221 safety glass, smooth on both sides or decorative glass
- drop-down seal
- replacement with a magnetic lock in black, white or gold for non-rebated door leaves
- change to hinges and strike plate in black, white or gold for non-rebated door leaves
- standard PL2112 +15% to the price of the door leaf before extra charges
- glulam stiles

**UV LACQUER**



**AVAILABLE SOLUTIONS** (pp. 158-169)

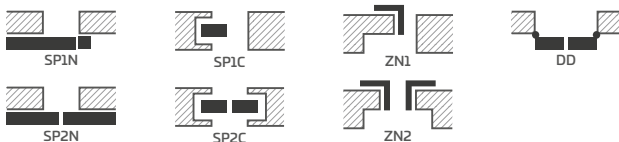

**AVAILABLE DOOR LEAF WIDTHS**



<sup>2)</sup> only for non-rebated door leaves

<sup>3)</sup> decorative crosshead with pilasters available at extra cost, p. 155



# JASMIN

LACQUERED DOOR LEAVES, REBATED, NON-REBATED AND REVERSIBLE

REGISTERED DESIGN  
**ERKADO**  
015099362-0001/015099362-0006



JASMIN 4 CASHMERE TITANIUM UV with BELLA SLIM handle, shiny brass



JASMIN 1



JASMIN 2



JASMIN 3



JASMIN 4



JASMIN 5<sup>\*)</sup>



JASMIN 6<sup>\*)</sup>



JASMIN 7<sup>\*)</sup>



JASMIN 8<sup>\*)</sup>

<sup>\*)</sup> The presented photos of JASMIN 5-8 doors refer only to the door leaf width "80". In other widths, there are differences in the proportions of the radii of the central panel in relation to the glass, which may affect the customer's product choice. Graphics showing the individual widths can be found at [www.erkado.pl](http://www.erkado.pl)

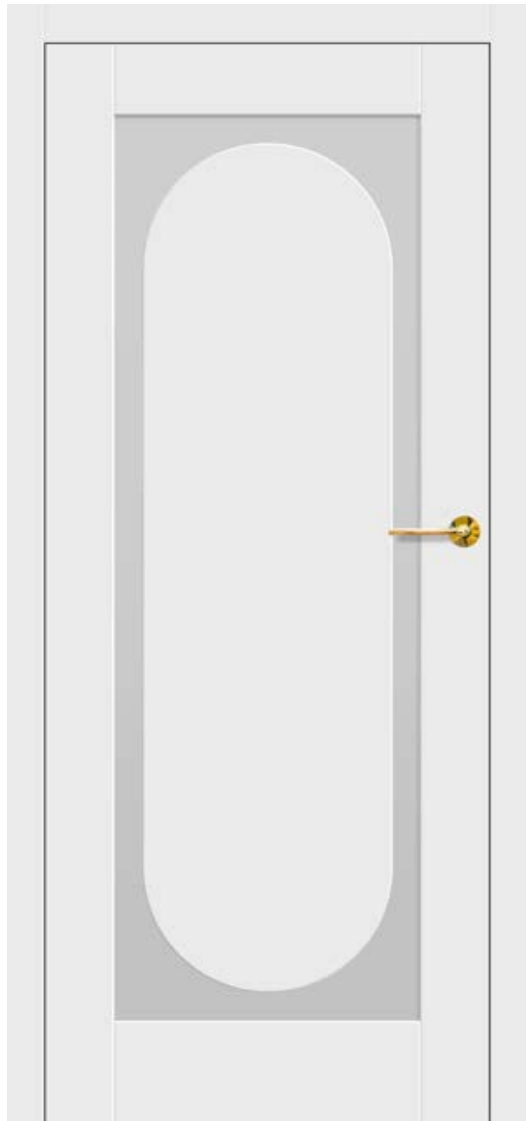

JASMIN 5 WHITE TITANIUM UV with BELLA SLIM handle, shiny brass

**DESIGN**

- rebated, non-rebated, or for an extra charge, reversible door leaf made with STILE technology
- vertical and horizontal rails made of MDF board, covered with laminate and painted with durable UV lacquer UV
- optionally, for an extra charge, vertical rails made of glulam covered with HDF and MDF boards
- panels made of 3 mm thick moisture-resistant HDF board glued on both sides to glass. The edge of the panel is in the color of the door leaf.
- the width of the transparency between the edge of the rail and the glued panel is 50 mm<sup>4)</sup>
- optional, with extra charges: door frame extension panels and a crosshead with pilasters, pp. 155-157.
- possibility to shorten the door leaf on your own, details p. 153

**FINISH**

- door leaves and frames painted with water-based lacquer cured with UV technology, which provides high resistance to demanding usage conditions

**HARDWARE**

- three silver 2-pin hinges with horizontal adjustment in the rebated door leaf or, for an extra charge, black ones
- two hinges (third for an extra charge) concealed in the non-rebated door leaf painted in silver color (optionally for an extra charge in black, gold or white); hinges are supplied and priced with the frame
- latch-bolt lock in the rebated door leaf and magnetic (optionally latch-bolt) in the non-rebated door leaf: for key, patent insert, economy or with a lock in silver color (for an extra charge in black); optionally, for an extra charge, magnetic lock in black, gold, or white color

**GLAZING**

- standard: tempered milk or clear glass 4 mm and for an extra charge laminated glass VSG 221 milk or black safety glass, smooth on both sides
- possibility to change the glazing side to REVERSE (OBSERVE is standard glazing), p. 154

**EXTRA CHARGES**

- factory through drilling for handles (so-called split) ordered as a set with the door leaf
- reversible door leaf
- enhanced airflow trim standard or mini, ventilation undercut standard or mini (p. 153)
- rebated and non-rebated door leaf "100"
- metal caps for hinges in rebated door leaves (colours: brushed nickel, patina, glossy chrome, glossy brass, white, and black)
- change to hinges, strike plate and lock in black color for rebated door leaves
- laminated glass VSG 221 safety glass, smooth on both side
- drop-down seal
- replacement with a magnetic lock in black, white or gold for non-rebated door leaves
- change to hinges and strike plate in black, white or gold for non-rebated door leaves
- standard PL2112 +15% to the price of the door leaf before extra charges
- glulam stiles

**UV LACQUER**

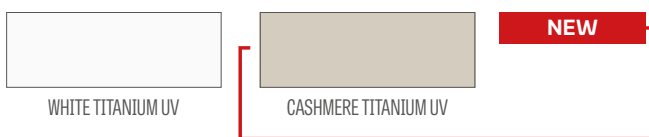

**AVAILABLE SOLUTIONS** (pp. 158-169)

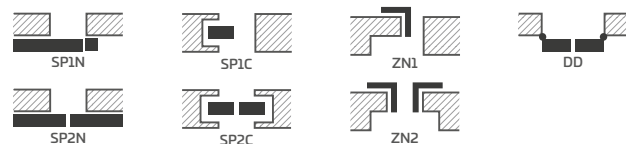

**AVAILABLE DOOR LEAF WIDTHS**



<sup>2)</sup> only for non-rebated door leaves

<sup>3)</sup> decorative crosshead with pilasters available at extra cost, p. 155

<sup>4)</sup> does not apply to arches



# AMARYLIS

LACQUERED DOOR LEAVES, REBATED, NON-REBATED AND REVERSIBLE



AMARYLIS 9 with BELLA SLIM handle, shiny brass, with decorative relief glazing, with decorative crosshead and pilasters<sup>3)</sup>



AMARYLIS 1



AMARYLIS 2



AMARYLIS 3



AMARYLIS 4



AMARYLIS 5



AMARYLIS 6



AMARYLIS 7



AMARYLIS 8



AMARYLIS 9



Double-sided adhesive  
muntin width 25 mm

AMARYLIS 6 with CUBE PREMIUM handle, black matt, with decorative relief glazing



## DESIGN

- rebated, non-rebated, or for an extra charge, reversible door leaf made with STILE technology
- vertical and horizontal rails made of MDF board, covered with laminate and painted with durable lacquer UV
- optionally, for an extra charge, vertical rails made of glulam covered with HDF and MDF boards
- double-sided muntin glued on glass, width 25 mm and height respectively: vertical 12 mm and horizontal 8 mm
- optional, with extra charges: door frame extension panels and a crosshead with pilasters, pp. 155–157.
- possibility to shorten the door leaf on your own, details p. 153

## FINISH

- door leaves and frames painted with water-based lacquer cured with UV technology, which provides high resistance to demanding usage conditions

## HARDWARE

- three silver 2-pin hinges with horizontal adjustment in the rebated door leaf or, for an extra charge, black ones
- two hinges (third for an extra charge) concealed in the non-rebated door leaf painted in silver color (optionally for an extra charge in black, gold or white); hinges are supplied and priced with the frame
- latch-bolt lock in the rebated door leaf and magnetic (optionally latch-bolt) in the non-rebated door leaf: for key, patent insert, economy or with a lock in silver color (for an extra charge in black); optionally, for an extra charge, magnetic lock in black, gold, or white color

## GLAZING

- standard: frosted or clear tempered glass 4 mm, and for an extra charge laminated VSG 221 glass, frosted or black safe, smooth on both sides, or decorative tempered glass 4 mm relief and point **NEW** (relief and point glass smooth on one side)
- possibility to change the glazing side to REVERSE (OBSERVE is standard glazing), p. 154

## EXTRA CHARGES

factory through drilling for handles (so-called split) ordered as a set with the door leaf

reversible door leaf

enhanced airflow trim standard or mini, ventilation undercut standard or mini (p. 153)

rebated and non-rebated door leaf "100"

metal caps for hinges in rebated door leaves (colours: brushed nickel, patina, glossy chrome, glossy brass, white, and black)

change to hinges, strike plate and lock in black color for rebated door leaves

laminated glass VSG 221 safety glass, smooth on both sides or decorative glass

drop-down seal

replacement with a magnetic lock in black, white or gold for non-rebated door leaves

change to hinges and strike plate in black, white or gold for non-rebated door leaves

standard PL2112

+15% to the price of the door leaf before extra charges

glulam stiles

## UV LACQUER

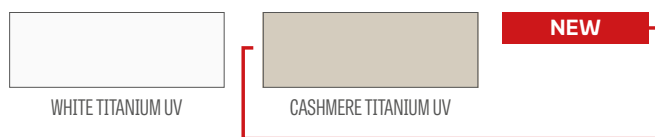

## AVAILABLE SOLUTIONS (pp. 158-169)

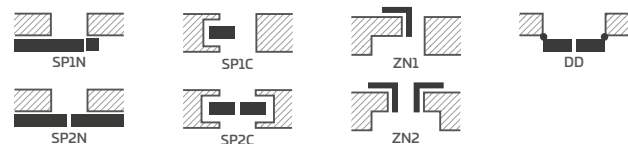

## AVAILABLE DOOR LEAF WIDTHS

**NEW**

60 65 70 75 80N<sup>2)</sup> 80 85 90 95 100

<sup>2)</sup> only for non-rebated door leaves

<sup>3)</sup> decorative crosshead with pilasters available at extra cost, p. 155

<sup>4)</sup> while stocks last



# PEONIA

LACQUERED DOOR LEAVES, REBATED, NON-REBATED AND REVERSIBLE



PEONIA 1 with BELLA SLIM handle, shiny brass, with decorative crosshead and pilasters<sup>3)</sup>



PEONIA 1



PEONIA 2



PEONIA 3



Double-sided adhesive muntin width 25 mm



PEONIA 4



PEONIA 5



PEONIA 6

PEONIA 2 with CUBE handle, black matt, with decorative crosshead and pilasters<sup>3)</sup>



## DESIGN

- rebated, non-rebated, or for an extra charge, reversible door leaf made with STILE technology
- vertical and horizontal rails made of MDF board, covered with laminate and painted with durable lacquer UV
- optionally, for an extra charge, vertical rails made of glulam covered with HDF and MDF boards
- panels made of 16 mm thick HDF board painted with durable lacquer UV
- double-sided muntin glued on glass, width 25 mm and height respectively: vertical 12 mm and horizontal 8 mm
- optional, with extra charges: door frame extension panels and a crosshead with pilasters, pp. 155–157.
- possibility to shorten the door leaf on your own, details p. 153

## FINISH

- door leaves and frames painted with water-based lacquer cured with UV technology, which provides high resistance to demanding usage conditions

## HARDWARE

- three silver 2-pin hinges with horizontal adjustment in the rebated door leaf or, for an extra charge, black ones
- two hinges (third for an extra charge) concealed in the non-rebated door leaf painted in silver color (optionally for an extra charge in black, gold or white); hinges are supplied and priced with the frame
- latch-bolt lock in the rebated door leaf and magnetic (optionally latch-bolt) in the non-rebated door leaf: for key, patent insert, economy or with a lock in silver color (for an extra charge in black); optionally, for an extra charge, magnetic lock in black, gold, or white color

## GLAZING

- standard: frosted or clear tempered glass, and for an extra charge, VSG 221 laminated glass, frosted or black safety glass, smooth on both sides, or 4 mm decorative tempered glass relief and point **NEW** (relief and point glass smooth on one side)
- possibility to change the glazing side to REVERSE (OBVERSE is standard glazing), p. 154

## EXTRA CHARGES

factory through drilling for handles (so-called split) ordered as a set with the door leaf

reversible door leaf

enhanced airflow trim standard or mini, ventilation undercut standard or mini (p. 153)

rebated and non-rebated door leaf "100"

metal caps for hinges in rebated door leaves (colours: brushed nickel, patina, glossy chrome, glossy brass, white, and black)

change to hinges, strike plate and lock in black color for rebated door leaves

laminated glass VSG 221 safety glass, smooth on both sides or decorative glass

drop-down seal

replacement with a magnetic lock in black, white or gold for non-rebated door leaves

change to hinges and strike plate in black, white or gold for non-rebated door leaves

standard PL2112

+15% to the price of the door leaf before extra charges

glulam stiles

## UV LACQUER



WHITE TITANIUM UV



CASHMERE TITANIUM UV

**NEW**

## AVAILABLE SOLUTIONS (pp. 158-169)

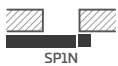

SP1N



SP1C

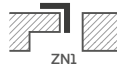

ZN1

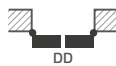

DD

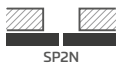

SP2N

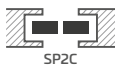

SP2C



ZN2

## AVAILABLE DOOR LEAF WIDTHS

**NEW**

60 65 70 75 80N<sup>2)</sup> 80 85 90 95 100

<sup>2)</sup> only for non-rebated door leaves

<sup>3)</sup> decorative crosshead with pilasters available at extra cost, p. 155

<sup>4)</sup> while stocks last



# MISKANT

LACQUERED DOOR LEAVES, REBATED, NON-REBATED AND REVERSIBLE



MISKANT 2 with BELLA SLIM handle, black matt



MISKANT 1



MISKANT 2

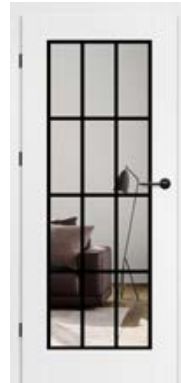

MISKANT 3



Black lines width 18 mm  
painted using screen printing  
technology



MISKANT 4



MISKANT 5



MISKANT 6

MISKANT 4 with BELLA SLIM handle, black matt



## DESIGN

- rebated, non-rebated, or for an extra charge, reversible door leaf made with STILE technology
- vertical and horizontal rails made of MDF board, covered with laminate and painted with durable lacquer UV
- optionally, for an extra charge, vertical rails made of glulam covered with HDF and MDF boards
- optional, with extra charges: door frame extension panels and a crosshead with pilasters, pp. 155-157.
- possibility to shorten the door leaf on your own, details p. 153

## FINISH

- door leaves and frames painted with water-based lacquer cured with UV technology, which provides high resistance to demanding usage conditions

## HARDWARE

- three silver 2-pin hinges with horizontal adjustment in the rebated door leaf or, for an extra charge, black ones
- two hinges (third for an extra charge) concealed in the non-rebated door leaf painted in silver color (optionally for an extra charge in black, gold or white); hinges are supplied and priced with the frame
- latch-bolt lock in the rebated door leaf and magnetic (optionally latch-bolt) in the non-rebated door leaf: for key, patent insert, economy or with a lock in silver color (for an extra charge in black); optionally, for an extra charge, magnetic lock in black, gold, or white color

## GLAZING

- frosted tempered glass (MISKANT 2, 4, 6) or clear (MISKANT 1, 3, 5) 4 mm thick, or for an extra charge, VSG laminated glass with internal application
- possibility to change the glazing side to REVERSE (OBERSE is standard glazing), p. 154
- black lines painted using screen printing technology on one side of the glass, width (thickness) 18 mm

## EXTRA CHARGES

factory through drilling for handles (so-called split) ordered as a set with the door leaf

reversible door leaf

VSG laminated glass, clear, with internal application in color black or white

enhanced airflow trim standard or mini, ventilation undercut standard or mini (p. 153)

rebated and non-rebated door leaf "100"

metal caps for hinges in rebated door leaves (colours: brushed nickel, patina, glossy chrome, glossy brass, white, and black)

change to hinges, strike plate and lock in black color for rebated door leaves

drop-down seal

replacement with a magnetic lock in black, white or gold for non-rebated door leaves

change to hinges and strike plate in black, white or gold for non-rebated door leaves

glulam stiles

## UV LACQUER



WHITE TITANIUM UV



CASHMERE TITANIUM UV

NEW

## AVAILABLE SOLUTIONS (pp. 158-169)

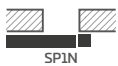

SP1N



SP1C

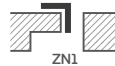

ZN1

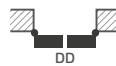

DD

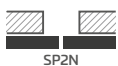

SP2N

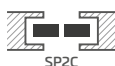

SP2C



ZN2

## AVAILABLE DOOR LEAF WIDTHS

NEW

60 65 70 75 80N<sup>2)</sup> 80 85 90 95 100

<sup>2)</sup> only for non-rebated door leaves

<sup>3)</sup> while stocks last



# NEMEZJA

LACQUERED DOOR LEAVES, REBATED, NON-REBATED AND REVERSIBLE



NEMEZJA 14 CASHMERE TITANIUM UV with BELLA SLIM handle, shiny brass, with decorative crosshead and pilasters<sup>3)</sup>



NEMEZJA 4



NEMEZJA 6



NEMEZJA 7



NEMEZJA 8



NEMEZJA 9

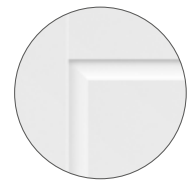

Beveled panel



NEMEZJA 10



NEMEZJA 11



NEMEZJA 12



NEMEZJA 15



NEMEZJA 16

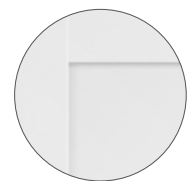

NEMEZJA 16  
Straight panel

NEMEZJA 8 with BELLA SLIM handle, shiny brass



## DESIGN

- rebated, non-rebated, or for an extra charge, reversible door leaf made with STILE technology
- vertical and horizontal rails made of MDF board, covered with laminate and painted with durable lacquer UV
- optionally, for an extra charge, vertical rails made of glulam covered with HDF and MDF boards
- panels made of 16 mm thick HDF board, beveled and smooth (NEMEZJA 15), painted with durable lacquer UV
- optional, with extra charges: door frame extension panels and a crosshead with pilasters, pp. 155-157.
- possibility to shorten the door leaf on your own, details p. 153

## FINISH

- door leaves and frames painted with water-based lacquer cured with UV technology, which provides high resistance to demanding usage conditions

## HARDWARE

- three silver 2-pin hinges with horizontal adjustment in the rebated door leaf or, for an extra charge, black ones
- two hinges (third for an extra charge) concealed in the non-rebated door leaf painted in silver color (optionally for an extra charge in black, gold or white); hinges are supplied and priced with the frame
- latch-bolt lock in the rebated door leaf and magnetic (optionally latch-bolt) in the non-rebated door leaf: for key, patent insert, economy or with a lock in silver color (for an extra charge in black); optionally, for an extra charge, magnetic lock in black, gold, or white color

## GLAZING

- standard: frosted or clear tempered glass, and for an extra charge, VSG 221 laminated glass, frosted or black safety glass, smooth on both sides, or 4 mm decorative tempered glass relief and point **NEW** for NEMEZJA 4, 7, 11, 15 (relief and point glass smooth on one side)
- possibility to change the glazing side to REVERSE (OBSERVE is standard glazing), p. 154

## EXTRA CHARGES

factory through drilling for handles (so-called split) ordered as a set with the door leaf

reversible door leaf

enhanced airflow trim standard or mini, ventilation undercut standard or mini (p. 153)

rebated and non-rebated door leaf "100"

metal caps for hinges in rebated door leaves (colours: brushed nickel, patina, glossy chrome, glossy brass, white, and black)

change to hinges, strike plate and lock in black color for rebated door leaves

laminated glass VSG 221 safety glass, smooth on both sides or decorative glass

drop-down seal

replacement with a magnetic lock in black, white or gold for non-rebated door leaves

change to hinges and strike plate in black, white or gold for non-rebated door leaves

standard PL2112

+15% to the price of the door leaf before extra charges

glulam stiles

## UV LACQUER



WHITE TITANIUM UV

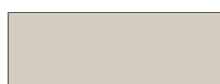

CASHMERE TITANIUM UV

**NEW**

## AVAILABLE SOLUTIONS (pp. 158-169)

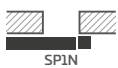

SP1N



SP1C



ZN1

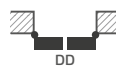

DD

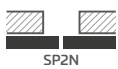

SP2N

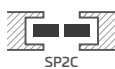

SP2C



ZN2

## AVAILABLE DOOR LEAF WIDTHS

**NEW**

60 65 70 75 80N<sup>2)</sup> 80 85 90 95 100

<sup>2)</sup> only for non-rebated door leaves

<sup>3)</sup> decorative crosshead with pilasters available at extra cost, p. 155

<sup>4)</sup> while stocks last



# LAURENCJA

LACQUERED DOOR LEAVES WITH REBATE, WITHOUT REBATE



LAURENCJA 1 with BELLA SLIM handle, black matt, with black VSG glazing



LAURENCJA 1



LAURENCJA 2



LAURENCJA 3



LAURENCJA 4



LAURENCJA 5



LAURENCJA 6

LAURENCIA 1 with BELLAJIM handle, black matt, and with black VSG 221 laminated glazing



## DESIGN

- rebated, non-rebated door leaf made with STILE technology
- vertical and horizontal rails made of MDF board, covered with laminate and painted with durable lacquer UV
- optionally, for an extra charge, vertical rails made of glulam covered with HDF and MDF boards
- panels made of 4 mm thick HDF board painted with durable lacquer UV
- optional, with extra charges: door frame extension panels and a crosshead with pilasters, pp. 155-157.
- possibility to shorten the door leaf on your own, details p. 153

## FINISH

- door leaves and frames painted with water-based lacquer cured with UV technology, which provides high resistance to demanding usage conditions

## HARDWARE

- three silver 2-pin hinges with horizontal adjustment in the rebated door leaf or, for an extra charge, black ones
- two hinges (third for an extra charge) concealed in the non-rebated door leaf painted in silver color (optionally for an extra charge in black, gold or white); hinges are supplied and priced with the frame
- latch-bolt lock in the rebated door leaf and magnetic (optionally latch-bolt) in the non-rebated door leaf: for key, patent insert, economy or with a lock in silver color (for an extra charge in black); optionally, for an extra charge, magnetic lock in black, gold, or white color

## GLAZING

- standard: frosted or clear glass, and for an extra charge, VSG 221 laminated glass, frosted or black safety glass, smooth on both sides
- possibility to change the glazing side to REVERSE (OBVERSE is standard glazing), p. 154

## EXTRA CHARGES

factory through drilling for handles (so-called split) ordered as a set with the door leaf

enhanced airflow trim standard or mini, ventilation undercut standard or mini (p. 153)

rebated and non-rebated door leaf "100"

metal caps for hinges in rebated door leaves (colours: brushed nickel, patina, glossy chrome, glossy brass, white, and black)

change to hinges, strike plate and lock in black color for rebated door leaves

laminated VSG 221 glass, safe, smooth on both sides

drop-down seal

replacement with a magnetic lock in black, white or gold for non-rebated door leaves

change to hinges and strike plate in black, white or gold for non-rebated door leaves

glulam stiles

## UV LACQUER



## AVAILABLE SOLUTIONS (pp. 158-169)

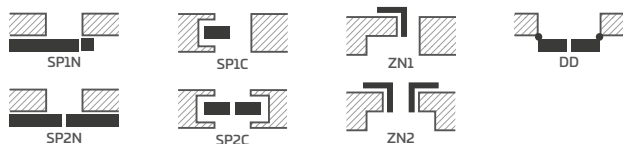

## AVAILABLE DOOR LEAF WIDTHS

NEW



<sup>2)</sup> only for non-rebated door leaves

<sup>3)</sup> while stocks last



# BALDUR

LACQUERED DOOR LEAVES, REBATED, NON-REBATED AND REVERSIBLE



BALDUR 1 with BELLA SLIM handle in black matt and glued VSG 441 black glazing



BALDUR 1



BALDUR 2



BALDUR 3



BALDUR 4



BALDUR 5



BALDUR 6



BALDUR 7



BALDUR 8

BALDUR 7 with CUBE PREMIUM handle in black matt



## DESIGN

- rebated, reverse, or non-rebated door leaf
- internal MDF frame covered with two HDF boards
- optional, for an additional fee, internal wooden stile (sides and top, bottom MDF) covered with two HDF boards
- stabilizing "honeycomb" filling or, for an extra charge, solid board filling
- optional, with extra charges: door frame extension panels and a crosshead with pilasters, pp. 155-157.
- possibility to shorten the door leaf on your own, details on p. 153 (does not apply to BALDUR 1, 3, 5)

## FINISH

- door leaves and frames painted with water-based lacquer cured with UV technology, which provides high resistance to demanding usage conditions
- door leaf edge made in standard or non-rebated technology
- in sliding systems, BALDUR 1 has a visible profile (17 mm high) at the bottom of the glass in aluminum or black color

## HARDWARE

- three screw-in pin hinges in the rebated door leaf, silver or, for an extra charge, black
- two hinges (third for an extra charge) hidden in the non-rebated door leaf and two hinges in the reverse door leaf (third for an extra charge) painted in silver (optionally for an extra charge in black, gold, or white); hinges are supplied and priced with the frame
- latch-bolt lock in the rebated door leaf and magnetic lock in the non-rebated door leaf (optionally latch-bolt): for key, patent insert, economy, or with lock in silver (for an extra charge in black); optionally for an extra charge, magnetic lock in black, gold, or white
- magnetic lock in the reverse door leaf: for key, patent insert, economy, or with lock in silver; optionally for an extra charge in black, gold, or white

## GLAZING

- **BALDUR 1, 3, 5 standard with glued and tempered glass VSG/ESG 441, safety glass, milky or black, smooth on both sides**
- fixed glazing width; BALDUR 1 - 50 mm, BALDUR 3, 5 - 210 mm

## UV LACQUER



## AVAILABLE SOLUTIONS<sup>1) 3)</sup> (pp. 158-169)

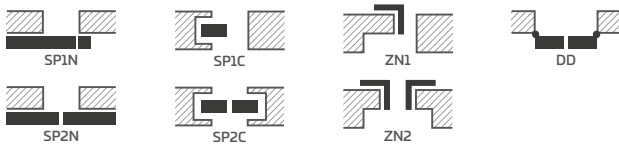

## AVAILABLE DOOR LEAF WIDTHS

NEW

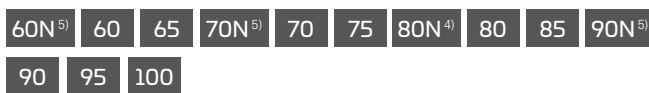

## VENTILATION UNDERCUT

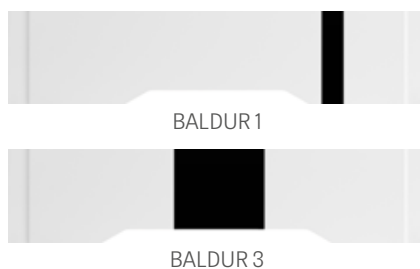

## EXTRA CHARGES

reverse door leaf

solid board filling

enhanced airflow trim standard or mini, ventilation undercut standard or mini (p. 153)

rebated and non-rebated door leaf "100"

additional bottom rail enabling

shortening the door leaf on your own up to max 8 cm (does not apply to model Baldur 1, 3, 5)

metal caps for hinges in rebated door leaves (colours: brushed nickel, patina, glossy chrome, glossy brass, white, and black)

change to hinges, strike plate and lock in black color for rebated door leaves

drop-down seal (does not apply to model BALDUR 1, 3, 5)

replacement with a magnetic lock in black, white, or gold for non-rebated and reverse door leaves

change to hinges and strike plate in black, white or gold for non-rebated door leaves

internal wooden stile (sides and top, bottom MDF)

standard PL2112

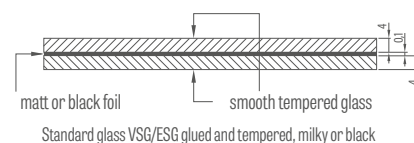

## MOULDING

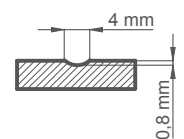

<sup>1)</sup> models BALDUR 3, 5 not available in sliding systems or in double-leaf doors

<sup>3)</sup> BALDUR 1 model not available in wall pocket systems

<sup>4)</sup> only for non-rebated and reverse door leaves

<sup>5)</sup> only BALDUR 1 non-rebated and reverse

<sup>6)</sup> while stocks last



# ANUBIS

LACQUERED DOOR LEAVES, REBATED, NON-REBATED AND REVERSIBLE



ANUBIS 1 in standard PL2112, with BELLA SLIM handle in shiny chrome



ANUBIS 1



ANUBIS 2



ANUBIS 3



ANUBIS 4



ANUBIS 5

ANUBIS 3 with BELLA SLIM handle in shiny brass



## DESIGN

- rebated, reverse, or non-rebated door leaf
- internal MDF frame covered with two HDF boards
- optional, for an additional fee, internal wooden stile (sides and top, bottom MDF) covered with two HDF boards
- stabilizing "honeycomb" filling or, for an extra charge, solid board filling
- optional, with extra charges: door frame extension panels and a crosshead with pilasters, pp. 155-157.
- possibility to shorten the door leaf on your own, details p. 153

## FINISH

- door leaves and frames painted with water-based lacquer cured with UV technology, which provides high resistance to demanding usage conditions
- door leaf edge made in standard or non-rebated technology

## HARDWARE

- three screw-in pin hinges in the rebated door leaf, silver or, for an extra charge, black
- two hinges (third available at extra charge) concealed in the non-rebated door leaf and two hinges in the reverse door leaf (third available at extra charge) painted in silver (optionally at extra charge in black, gold or white); hinges are supplied and priced with the frame
- latch-bolt lock in the rebated door leaf and magnetic lock in the non-rebated door leaf (optionally latch-bolt): for key, patent insert, economy, or with lock in silver (for an extra charge in black); optionally for an extra charge, magnetic lock in black, gold, or white
- magnetic lock in the reverse door leaf: for key, patent insert, economy, or with lock in silver; optionally for an extra charge in black, gold, or white

## MOULDING

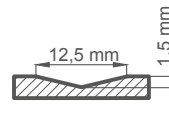

## EXTRA CHARGES

reverse door leaf

solid board filling

enhanced airflow trim standard or mini, ventilation undercut standard or mini (p. 153)

rebated and non-rebated door leaf "100"

additional bottom rail (possibility to shorten the door leaf by up to 8 cm on your own)

metal caps for hinges in rebated door leaves (colours: brushed nickel, patina, glossy chrome, glossy brass, white, and black)

change to hinges, strike plate and lock in black color for rebated door leaves

drop-down seal

replacement with a magnetic lock in black, white, or gold for non-rebated and reverse door leaves

change to hinges and strike plate in black, white or gold for non-rebated door leaves

internal wooden stile (sides and top, bottom MDF)

standard PL2112

## UV LACQUER



WHITE TITANIUM UV



CASHMERE TITANIUM UV

NEW

## AVAILABLE SOLUTIONS (pp. 158-169)

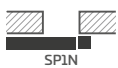

SP1N



SP1C

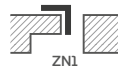

ZN1

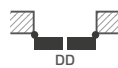

DD

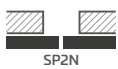

SP2N

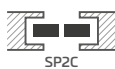

SP2C



ZN2

## AVAILABLE DOOR LEAF WIDTHS

60

70

80N<sup>2)</sup>

80

90

100

<sup>2)</sup> only for non-rebated and reverse door leaves

<sup>3)</sup> while stocks last



# UNO PREMIUM

LACQUERED DOOR LEAVES, REBATED, NON-REBATED AND REVERSIBLE



UNO PREMIUM with BELLA SLIM handle shiny brass

Non-rebated door; architrave 8 cm, 90° door frame joints, view from the frame side



Rebated door; architrave 8 cm, door frame joints 45°, view from the frame side



Rebated door; architrave 6 cm, door frame joints 45°, view from the hinge side



UNO PREMIUM with CUBE handle black matt



## DESIGN

- rebated, reverse, or non-rebated door leaf
- internal MDF frame covered with two HDF boards
- optional, for an additional fee, internal wooden stile (sides and top, bottom MDF) covered with two HDF boards
- stabilizing "honeycomb" filling or, for an extra charge, solid board filling
- optional, with extra charges: door frame extension panels and a crosshead with pilasters, pp. 155-157.
- possibility to shorten the door leaf on your own, details p. 153

## FINISH

- door leaves and frames painted with water-based lacquer cured with UV technology, which provides high resistance to demanding usage conditions
- door leaf edge made with standard technology

## HARDWARE

- three screw-in pin hinges in the rebated door leaf, silver or, for an extra charge, black
- two hinges (third available at extra charge) concealed in the non-rebated door leaf and two hinges in the reverse door leaf (third available at extra charge) painted in silver (optionally at extra charge in black, gold or white); hinges are supplied and priced with the frame
- latch-bolt lock in the rebated door leaf and magnetic lock in the non-rebated door leaf (optionally latch-bolt): for key, patent insert, economy, or with lock in silver (for an extra charge in black); optionally for an extra charge, magnetic lock in black, gold, or white
- magnetic lock in the reverse door leaf: for key, patent insert, economy, or with lock in silver; optionally for an extra charge in black, gold, or white

## EXTRA CHARGES

reverse door leaf

solid board filling

enhanced airflow trim standard or mini, ventilation undercut standard or mini (p. 153)

rebated and non-rebated door leaf "100"

rebated and non-rebated door leaf "110"

additional bottom rail (possibility to shorten the door leaf by up to 8 cm on your own)

metal caps for hinges in rebated door leaves (colours: brushed nickel, patina, glossy chrome, glossy brass, white, and black)

change to hinges, strike plate and lock in black color for rebated door leaves

drop-down seal

replacement with a magnetic lock in black, white, or gold for non-rebated and reverse door leaves

change to hinges and strike plate in black, white or gold for non-rebated door leaves

stainless steel porthole: polished "chrome" or brushed "satin" and black matt; decormat milky glass, clear glass, porthole diameter: inside 235 mm, outside 350 mm)

internal wooden stile (sides and top, bottom MDF)

standard PL2112

## UV LACQUER



WHITE TITANIUM UV



CASHMERE TITANIUM UV

NEW

## AVAILABLE SOLUTIONS (pp. 158-169)

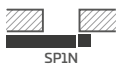

SP1N



SP1C

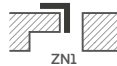

ZN1



DD

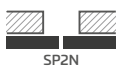

SP2N

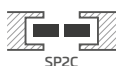

SP2C



ZN2

## AVAILABLE DOOR LEAF WIDTHS

NEW

60N <sup>2)</sup>	60	65	70N <sup>2)</sup>	70	75	80N <sup>2)</sup>	80	85	90N <sup>2)</sup>
90	95	100	110						

<sup>2)</sup> only for non-rebated and reverse door leaves

<sup>3)</sup> while stocks last

# TURAN

LACQUERED DOOR LEAVES, REBATED, NON-REBATED AND REVERSIBLE



finalist  
of the competition



2019



TURAN 8<sup>3)</sup> in standard PL2112, with VSG 221 black laminated glazing, with QUANTA FIT handle black matt



TURAN 1



TURAN 2



TURAN 3



TURAN 4



TURAN 5



TURAN 6



TURAN 7<sup>1)</sup>



TURAN 8

<sup>1)</sup> the REVERSE version shown in the photo

TURAN 6 with BELLA SLIM handle black matt.



## DESIGN

- rebated, non-rebated, or for an extra charge, reversible door leaf made with STILE technology
- vertical and horizontal rails made of MDF board, covered with laminate and painted with durable UV lacquer UV
- optionally, for an extra charge, vertical rails made of glulam covered with HDF and MDF boards
- in the TURAN 8 model<sup>3)</sup> panel made of 3 mm moisture-resistant HDF board glued on both sides to the glass. The edge of the panel is always in the color of the door leaf.
- panels made of 16 mm MDF board, milled and painted with durable UV lacquer
- optional, with extra charges: door frame extension panels and a crosshead with pilasters, pp. 155–157.
- possibility to shorten the door leaf on your own, details p. 153

## FINISH

- door leaves and frames painted with water-based lacquer cured with UV technology, which provides high resistance to demanding usage conditions

## HARDWARE

- three silver 2-pin hinges with horizontal adjustment in the rebated door leaf or, for an extra charge, black ones
- two hinges (third for an extra charge) concealed in the non-rebated door leaf painted in silver color (optionally for an extra charge in black, gold or white); hinges are supplied and priced with the frame
- latch-bolt lock in the rebated door leaf and magnetic (optionally latch-bolt) in the non-rebated door leaf: for key, patent insert, economy or with a lock in silver color (for an extra charge in black); optionally, for an extra charge, magnetic lock in black, gold, or white color

## GLAZING

- TURAN 1 and TURAN 8 model: 4 mm tempered milky or clear glass and, at extra charge, VSG 221 laminated glass, milky or black safety glass, smooth on both sides or 4 mm tempered decorative glass relief and point **NEW** for TURAN 1 (relief and point glass smooth on one side)
- TURAN 7 model available with mirror on one side. The other side – lacquered board with UV. Front – mirror on the hinge side.
- TURAN 8 model fixed glazing width - 50 mm

## EXTRA CHARGES

factory through drilling for handles (so-called split) ordered as a set with the door leaf

reversible door leaf

enhanced airflow trim standard or mini, ventilation undercut standard or mini (p. 153)

rebated and non-rebated door leaf "100"

metal caps for hinges in rebated door leaves (colours: brushed nickel, patina, glossy chrome, glossy brass, white, and black)

change to hinges, strike plate and lock in black color for rebated door leaves

VSG 221 laminated glass, safety glass, smooth on both sides (applies to TURAN 1 and TURAN 8) or decorative glass

drop-down seal

replacement with a magnetic lock in black, white or gold for non-rebated door leaves

change to hinges and strike plate in black, white or gold for non-rebated door leaves

standard PL2112

+15% to the price of the door leaf before extra charges

glulam stiles

## UV LACQUER



WHITE TITANIUM UV



CASHMERE TITANIUM UV

**NEW**

## AVAILABLE SOLUTIONS (pp. 158-169)

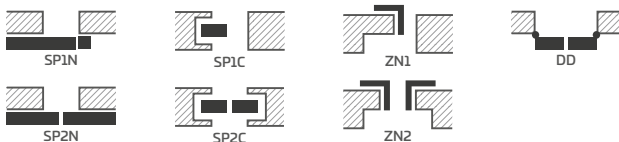

## AVAILABLE DOOR LEAF WIDTHS

60 70 80N<sup>2)</sup> 80 90 100

## MOULDING

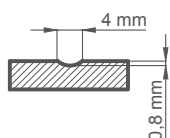

<sup>2)</sup> only for non-rebated door leaves



# MILDA

LACQUERED DOOR LEAVES, REBATED, NON-REBATED AND REVERSIBLE

product recommended  
for the competition



2019



MILDA 4 with CUBE PREMIUM handle black matt



MILDA 1



MILDA 2



MILDA 3



MILDA 4



MILDA 5

MILDA 2 with CUBE PREMIUM handle black matt



## DESIGN

- rebated, reverse, or non-rebated door leaf
- internal MDF frame covered with two HDF boards
- optional, for an additional fee, internal wooden stile (sides and top, bottom MDF) covered with two HDF boards
- stabilizing "honeycomb" filling or, for an extra charge, solid board filling
- optional, with extra charges: door frame extension panels and a crosshead with pilasters, pp. 155-157.
- possibility to shorten the door leaf on your own, details p. 153

## FINISH

- door leaves and frames painted with water-based lacquer cured with UV technology, which provides high resistance to demanding usage conditions
- door leaf edge made in standard or non-rebated technology

## HARDWARE

- three screw-in pin hinges in the rebated door leaf, silver or, for an extra charge, black
- two hinges (third available at extra charge) concealed in the non-rebated door leaf and two hinges (third available at extra charge) in the reverse door leaf painted in silver (optionally at extra charge in black, gold or white); hinges are supplied and priced with the frame
- latch-bolt lock in the rebated door leaf and magnetic lock in the non-rebated door leaf (optionally latch-bolt): for key, patent insert, economy, or with lock in silver (for an extra charge in black); optionally for an extra charge, magnetic lock in black, gold, or white
- magnetic lock in the reverse door leaf: for key, patent insert, economy, or with lock in silver; optionally for an extra charge in black, gold, or white

## MOULDING

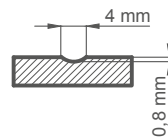

## EXTRA CHARGES

- reverse door leaf
- solid board filling
- enhanced airflow trim standard or mini, ventilation undercut standard or mini (p. 153)
- rebated and non-rebated door leaf "100"
- additional bottom rail (possibility to shorten the door leaf by up to 8 cm on your own)
- metal caps for hinges in rebated door leaves (colours: brushed nickel, patina, glossy chrome, glossy brass, white, and black)
- change to hinges, strike plate and lock in black color for rebated door leaves
- drop-down seal
- replacement with a magnetic lock in black, white, or gold for non-rebated and reverse door leaves
- change to hinges and strike plate in black, white or gold for non-rebated door leaves
- internal wooden stile (sides and top, bottom MDF)
- standard PL2112

## UV LACQUER



## AVAILABLE SOLUTIONS (pp. 158-169)

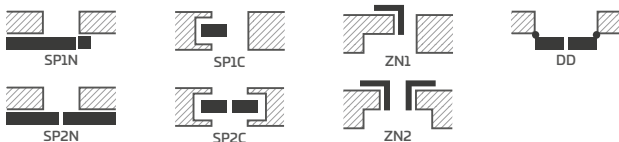

## AVAILABLE DOOR LEAF WIDTHS



<sup>2)</sup> only for non-rebated and reverse door leaves

<sup>3)</sup> while stocks last



# SYLENA

LACQUERED DOOR LEAVES, REBATED, NON-REBATED AND REVERSIBLE



SYLENA 5 with BELLA SLIM handle shiny brass



SYLENA 1



SYLENA 2



SYLENA 3



SYLENA 4



SYLENA 5



SYLENA 6



SYLENA 7



SYLENA 8

SYLENA 3 with BELLA SLIM handle black matt



## DESIGN

- rebated, reverse, or non-rebated door leaf
- internal MDF frame covered with two HDF boards
- optional, for an additional fee, internal wooden stile (sides and top, bottom MDF) covered with two HDF boards
- stabilizing "honeycomb" filling or, for an extra charge, solid board filling
- optional, with extra charges: door frame extension panels and a crosshead with pilasters, pp. 155–157.
- possibility to shorten the door leaf on your own, details p. 153

## FINISH

- door leaves and frames painted with water-based lacquer cured with UV technology, which provides high resistance to demanding usage conditions
- door leaf edge made in standard or non-rebated technology

## HARDWARE

- three screw-in pin hinges in the rebated door leaf, silver or, for an extra charge, black
- two hinges (third for an extra charge) hidden in the non-rebated door leaf and two hinges (third for an extra charge) in the reversible leaf painted in silver (optionally for an extra charge in black, gold or white); hinges are supplied and priced with the frame
- latch-bolt lock in the rebated door leaf and magnetic lock in the non-rebated door leaf (optionally latch-bolt): for key, patent insert, economy, or with lock in silver (for an extra charge in black); optionally for an extra charge, magnetic lock in black, gold, or white
- magnetic lock in the reverse door leaf: for key, patent insert, economy, or with lock in silver; optionally for an extra charge in black, gold, or white

## MOULDING

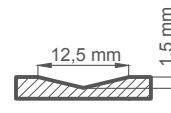

## EXTRA CHARGES

reverse door leaf

solid board filling

enhanced airflow trim standard or mini, ventilation undercut standard or mini (p. 153)

rebated and non-rebated door leaf "100"

additional bottom rail (possibility to shorten the door leaf by up to 8 cm on your own)

metal caps for hinges in rebated door leaves (colours: brushed nickel, patina, glossy chrome, glossy brass, white, and black)

change to hinges, strike plate and lock in black color for rebated door leaves

drop-down seal

replacement with a magnetic lock in black, white, or gold for non-rebated and reverse door leaves

change to hinges and strike plate in black, white or gold for non-rebated door leaves

internal wooden stile (sides and top, bottom MDF)

standard PL2112

## UV LACQUER



WHITE TITANIUM UV



CASHMERE TITANIUM UV

NEW

## AVAILABLE SOLUTIONS (pp. 158-169)

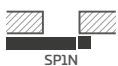

SP1N



SP1C



ZN1



DD

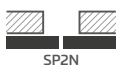

SP2N

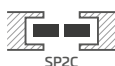

SP2C



ZN2

## AVAILABLE DOOR LEAF WIDTHS

60

70

80N<sup>2)</sup>

80

90

100

<sup>2)</sup> only for non-rebated and reverse door leaves

<sup>3)</sup> while stocks last



# INLAYS

DECORATIVE INSERT FLUSH WITH THE SURFACE OF THE LAMINATE



ALTAMURA 1 in BLACK ST CPL decor, with LUX 614 inlay, with QUANTA FIT handle black matt



NEW

## LUX INLAY RED, BLUE and OLIVE

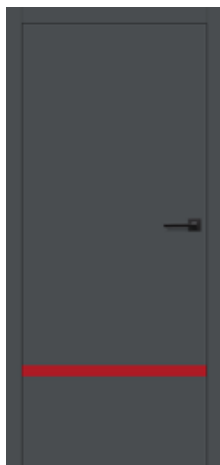

inlay LUX 617

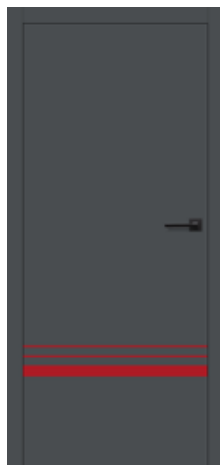

inlay LUX 618

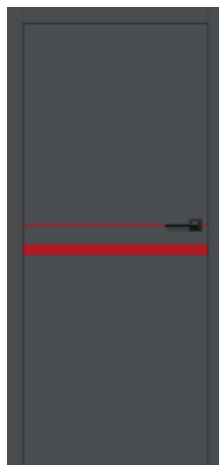

inlay LUX 619



inlay LUX 620



inlay LUX 621



inlay LUX 703



inlay LUX 704



inlay LUX 712



inlay LUX 713

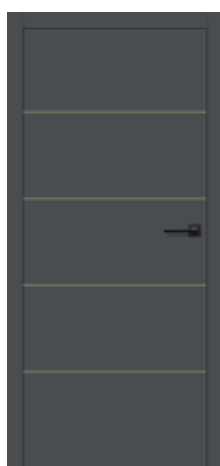

inlay LUX 807



inlay LUX 814



inlay LUX 816

Frame and door leaf ANTHRACITE ST CPL

**INLAYS** are placed on both sides of the door leaf and are flush with its surface. The width of the inlay is 8 mm or 50 mm. Inlays in red, blue and olive colors are available in all combinations, just like black, steel, gold, oak or copper inlays.

Available LUX INLAY colors:  
brushed steel **LUX 100**, black **LUX 200**, oak (compatible with OAK CLASSIC CPL 0.2 and 0.7) **LUX 300**,  
brushed gold **LUX 400**, brushed copper **LUX 500**,  
red **LUX 600**, blue **LUX 700**, olive **LUX 800**

The presented INLAYS can optionally be used for an extra charge in the following models available in PL and standard PL2112 (if available):

- UNO PREMIUM laminate
- ALTAMURA 1
- FORTECA RC2 and RC3
- HERSE SET ECO 30 dB
- HERSE SET 32 dB
- HERSE SET AKUSTIC 39 dB
- LEDA EI30 and EI60



# INLAYS

DECORATIVE INSERT FLUSH WITH THE SURFACE OF THE LAMINATE

## LUX INLAY BLACK



inlay LUX 217



inlay LUX 218



inlay LUX 219



inlay LUX 220



inlay LUX 221



inlay LUX 203



inlay LUX 204



inlay LUX 212



inlay LUX 213



inlay LUX 207



inlay LUX 214



inlay LUX 216

Frame BLACK ST CPL door leaf OAK CLASSIC CPL

**INLAYS** are placed on both sides of the door leaf and are flush with its surface. The width of the inlay is 8 mm or 50 mm.

Available LUX INLAY colors:  
brushed steel **LUX 100**, black **LUX 200**, oak (compatible with OAK CLASSIC CPL 0.2 and 0.7) **LUX 300**,  
brushed gold **LUX 400**, brushed copper **LUX 500**,  
red **LUX 600**, blue **LUX 700**, olive **LUX 800**

The presented INLAYS can optionally be used for an extra charge in the following models available in PL and standard PL212 (if available):

- UNO PREMIUM laminate
- ALTAMURA 1
- FORTEGA RC2 and RC3
- HERSE SET ECO 30 dB
- HERSE SET 32 dB
- HERSE SET AKUSTIC 39 dB
- LEDA EI30 and EI60

INLAY LUX **OAK**



inlay LUX 317



inlay LUX 318



inlay LUX 319



inlay LUX 320



inlay LUX 321



inlay LUX 303



inlay LUX 304



inlay LUX 312



inlay LUX 313



inlay LUX 307



inlay LUX 314



inlay LUX 316

Frame OAK CLASSIC CPL 0.2 door leaf WHITE ST CPL

**INLAYS** are placed on both sides of the door leaf and are flush with its surface. The width of the inlay is 8 mm or 50 mm.

Available LUX INLAY colors:  
 brushed steel **LUX 100**, black **LUX 200**, oak (compatible with OAK CLASSIC CPL 0.2 and 0.7) **LUX 300**,  
 brushed gold **LUX 400**, brushed copper **LUX 500**,  
 red **LUX 600**, blue **LUX 700**, olive **LUX 800**

The presented INLAYS can optionally be used for an extra charge in the following models available in PL and standard PL2112 (if available):

- UNO PREMIUM laminate
- ALTAMURA 1
- FORTECA RC2 and RC3
- HERSE SET ECO 30 dB
- HERSE SET 32 dB
- HERSE SET AKUSTIC 39 dB
- LEDA EI30 and EI60



# INLAYS

DECORATIVE INSERT FLUSH WITH THE SURFACE OF THE LAMINATE

## INLAY LUX BRUSHED STEEL



inlay LUX 117

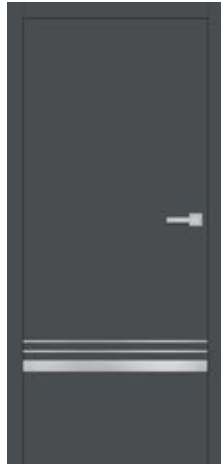

inlay LUX 118



inlay LUX 119



inlay LUX 120

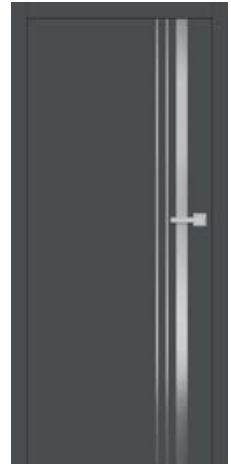

inlay LUX 121

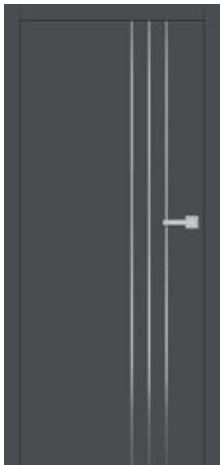

inlay LUX 103



inlay LUX 104



inlay LUX 112



inlay LUX 113

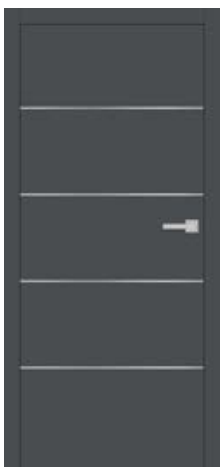

inlay LUX 107

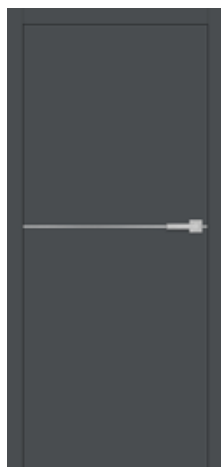

inlay LUX 114



inlay LUX 116

Frame and door leaf ANTHRACITE ST CPL

**INLAYS** are placed on both sides of the door leaf and are flush with its surface. The width of the inlay is 8 mm or 50 mm.

Available LUX INLAY colors:  
brushed steel **LUX 100**, black **LUX 200**, oak (compatible with OAK CLASSIC CPL 0.2 and 0.7) **LUX 300**,  
brushed gold **LUX 400**, brushed copper **LUX 500**,  
red **LUX 600**, blue **LUX 700**, olive **LUX 800**

The presented INLAYS can optionally be used for an extra charge in the following models available in PL and standard PL2112 (if available):

- UNO PREMIUM laminate
- ALTAMURA 1
- FORTEGA RC2 and RC3
- HERSE SET ECO 30 dB
- HERSE SET 32 dB
- HERSE SET AKUSTIC 39 dB
- LEDA EI30 and EI60

The photos show non-rebated doors with an economy lock, in other types of doors the lock positions may differ.

## INLAY LUX BRUSHED COPPER



inlay LUX 517



inlay LUX 518



inlay LUX 519



inlay LUX 520



inlay LUX 521



inlay LUX 503



inlay LUX 504



inlay LUX 512



inlay LUX 513



inlay LUX 507



inlay LUX 514



inlay LUX 516

Frame and door leaf SAGE ST CPL

**INLAYS** are placed on both sides of the door leaf and are flush with its surface. The width of the inlay is 8 mm or 50 mm.

Available LUX INLAY colors:  
 brushed steel **LUX 100**, black **LUX 200**, oak (compatible with OAK CLASSIC CPL 0.2 and 0.7) **LUX 300**,  
 brushed gold **LUX 400**, brushed copper **LUX 500**,  
 red **LUX 600**, blue **LUX 700**, olive **LUX 800**

The presented INLAYS can optionally be used for an extra charge in the following models available in PL and standard PL2112 (if available):

- UNO PREMIUM laminate
- ALTAMURA 1
- FORTECA RC2 and RC3
- HERSE SET ECO 30 dB
- HERSE SET 32 dB
- HERSE SET AKUSTIC 39 dB
- LEDA EI30 and EI60



# INLAYS

DECORATIVE INSERT FLUSH WITH THE SURFACE OF THE LAMINATE

## INLAY LUX BRUSHED GOLD



inlay LUX 417

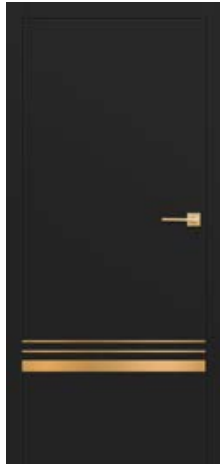

inlay LUX 418

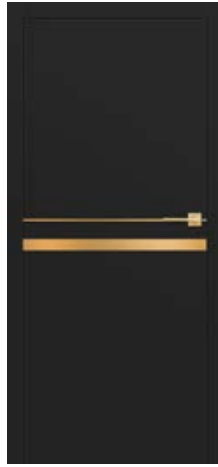

inlay LUX 419

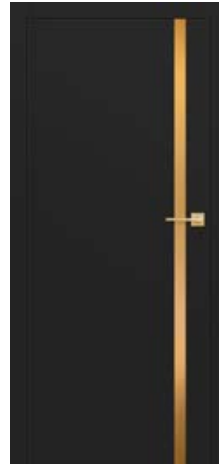

inlay LUX 420



inlay LUX 421



inlay LUX 403

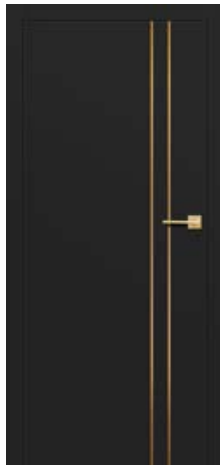

inlay LUX 404

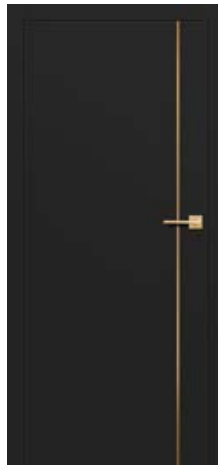

inlay LUX 412



inlay LUX 413



inlay LUX 407



inlay LUX 414

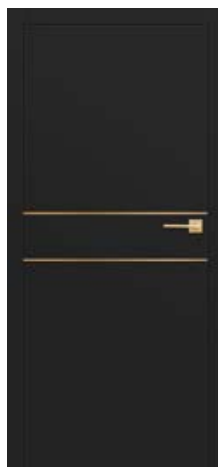

inlay LUX 416

Frame and door leaf BLACK ST CPL

**INLAYS** are placed on both sides of the door leaf and are flush with its surface. The width of the inlay is 8 mm or 50 mm.

Available LUX INLAY colors:  
brushed steel **LUX 100**, black **LUX 200**, oak (compatible with OAK CLASSIC CPL 0.2 and 0.7) **LUX 300**,  
brushed gold **LUX 400**, brushed copper **LUX 500**,  
red **LUX 600**, blue **LUX 700**, olive **LUX 800**

The presented INLAYS can optionally be used for an extra charge in the following models available in PL and standard PL2112 (if available):

- UNO PREMIUM laminate
- ALTAMURA 1
- FORTEGA RC2 and RC3
- HERSE SET ECO 30 dB
- HERSE SET 32 dB
- HERSE SET AKUSTIC 39 dB
- LEDA EI30 and EI60

The photos show non-rebated doors with an economy lock, in other types of doors the lock positions may differ.

# INLAYS

DECORATIVE INSERT FLUSH WITH THE SURFACE OF THE LAMINATE



ALTAMURA 1 in BLACK ST CPL decor; with LUX 421 inlay; with BELLA SLIM square handle satin brass



# BALDUR

INTERIOR DOOR LEAVES: REBATED, NON-REBATED, AND REVERSIBLE



BALDUR 1 in NATUR OAK PREMIUM decor, with frame in BLACK ST CPL decor, with QUBIK handle black matt

BALDUR 1 in OAK RETRO CPL decor, with frame in BLACK ST CPL decor, with CUBE PREMIUM handle black matt



BALDUR 1

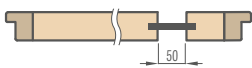

8 mm frosted tempered glass or, for an extra charge, VSG/ESG 441 glass frosted or black pane.

BALDUR 3 in OAK ST CPL decor, with frame in BLACK ST CPL decor, with CUBE PREMIUM handle black matt



BALDUR 3

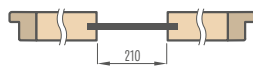

8 mm frosted tempered glass or, for an extra charge, VSG/ESG 441 glass frosted or black pane.

NEW

BALDUR 9 in OAK CLASSIC CPL decor, with frame in BLACK ST CPL decor, with CUBE PREMIUM handle black matt



BALDUR 9

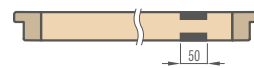

Black lacobel glass 4 mm glued on both sides into the door leaf and flush with its surface.

## DESIGN

- rebated, reverse, or non-rebated door leaf
- internal MDF frame covered with two HDF boards
- optional, for an additional fee, internal wooden stile (sides and top, bottom MDF) covered with two HDF boards
- stabilizing "honeycomb" filling or, for an extra charge, solid board filling
- optional, with extra charges: door frame extension panels and a crosshead with pilasters, pp. 155-157.

## FINISH

- HDF board covered with PREMIUM or CPL laminate
- door leaf edge made in standard rebate technology or rebated in CPL laminates 0.2, edged with ABS only in the color of the door leaf or, for an extra charge, with standard black edging
- the reversible door leaf is available only with STANDARD edge and in PREMIUM and ST CPL decors
- the edge of the door leaf is edged in the color of the surface or optionally in smooth black (in the NATUR OAK TRANSVERSE PREMIUM decor, the black edge has a transverse structure). The edge in black colors is edged partially around the perimeter (two vertical and top) and at the glass.
- BALDUR 1 rebated and non-rebated door leaf only for WHITE ST CPL decor optionally made in soft technology (no visible longitudinal edge laminate joints) requiring the use of a full board for an extra charge. Soft technology is not available in standard PL2112.
- in sliding systems BALDUR 1 has a visible profile at the bottom with a height of 17 mm in aluminum or black color

## HARDWARE

- three screw-in pin hinges in the rebated door leaf, silver or, for an extra charge, black
- two hinges (third for an extra charge) hidden in the non-rebated door leaf and two hinges (third for an extra charge) in the reversible leaf painted in silver (optionally for an extra charge in black, gold or white); hinges are supplied and priced with the frame
- latch-bolt lock in the rebated door leaf and magnetic lock in the non-rebated door leaf (optionally latch-bolt): for key, patent insert, economy or with lock in silver color (for an extra charge in black); optionally for an extra charge magnetic lock in black, gold or white
- magnetic lock in the reversible leaf: for key, patent insert, economy or with lock in silver color; optionally for an extra charge in black, gold or white

## GLAZING

- BALDUR 1, 3 frosted tempered glass 8 mm or, for an extra charge, laminated and tempered VSG/ESG 441 safety glass, frosted or black, smooth on both sides
- BALDUR 9 **NEW** 4 mm black glass flush on both sides with the surface of the door leaf
- visual width of the glass: BALDUR 1 and 9 – 50 mm, BALDUR 3 – 210 mm

## CPL

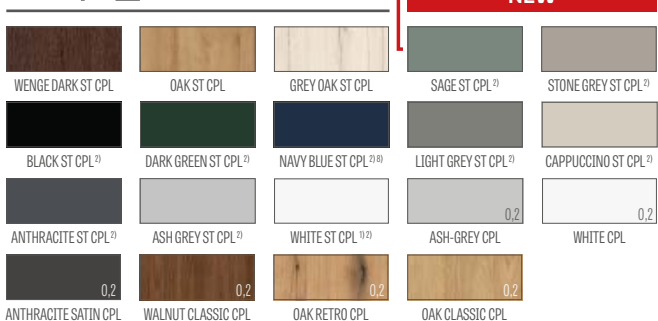

## PREMIUM



## EXTRA CHARGES

**reversible door leaf** (not available in CPL 0.2 and for BALDUR 1 with SOFT edge)

solid board filling

enhanced airflow trim standard or mini, ventilation undercut standard or mini (p. 153)

rebated and non-rebated door leaf "100"

VSG/ESG 441 glass frosted or black pane

metal hinge caps in the rebated door leaf (brushed nickel, patina, chrome gloss, brass gloss, white and black)

change to hinges, strike plate and lock in black color for rebated door leaves

black door leaf edge finish

change to magnetic lock in black, white or gold for non-rebated and reversible door leaves

change to hinges and strike plate in black, white or gold for non-rebated door leaves

internal wooden stile (sides and top, bottom MDF)

standard PL2112

+ 15% to the price of the door leaf before surcharges

## AVAILABLE DOOR LEAF WIDTHS **NEW**



## AVAILABLE SOLUTIONS <sup>3)</sup> (pp. 158-169)



## TYPES OF EDGE FINISHES



EDGE FINISH OF THE DOOR LEAF BLACK SMOOTH



EDGE FINISH OF THE DOOR LEAF BLACK TRANSVERSE

## VENTILATION UNDERCUT



<sup>1)</sup> smooth white laminate imitating a painted surface

<sup>2)</sup> special **AntiFinger** coating limiting dirt and fingerprints

<sup>3)</sup> BALDUR 3 model not available in sliding systems or double-leaf doors

<sup>4)</sup> only soft version for BALDUR 1 rebated and non-rebated in WHITE ST CPL decor and available only at extra charge with solid board filling (soft option not available in standard PL2112)

<sup>5)</sup> in the set, the frame is made in NATUR OAK PREMIUM decor

<sup>6)</sup> only for non-rebated and reversible door leaves

<sup>7)</sup> only BALDUR 1 and BALDUR 9 non-rebated and reversible, not available with soft edge

<sup>8)</sup> while stocks last



# UNO PREMIUM

INTERIOR DOOR LEAVES: REBATED, NON-REBATED, AND REVERSIBLE



UNO PREMIUM in OAK PREMIUM decor, with frame in BLACK ST CPL decor, with CUBE PREMIUM handle black matt

UNO PREMIUM in NATUR OAK TRANSVERSE PREMIUM decor, with CUBE handle black matt



UNO PREMIUM in GRAPHITE ASH PREMIUM decor, with CUBE handle black matt



UNO PREMIUM in WALNUT CLASSIC PREMIUM decor, with CUBE handle black matt



UNO PREMIUM in WHITE PREMIUM decor, with BELLA SLIM handle black matt



## DESIGN

- rebated, reverse, or non-rebated door leaf
- internal MDF frame covered with two HDF boards
- optional, for an additional fee, internal wooden stile (sides and top, bottom MDF) covered with two HDF boards
- stabilizing "honeycomb" filling
- solid board filling available at extra charge
- optional, with extra charges: door frame extension panels and a crosshead with pilasters, pp. 155-157.
- possibility to shorten the door leaf on your own, details p. 153

## FINISH

- HDF board covered with PREMIUM laminate
- door leaf edge made in standard rebated or non-rebated technology
- edge finished with edging in the color of the door leaf surface or optionally in smooth black (in NATUR OAK TRANSVERSE PREMIUM decor, black edging with transverse structure)
- inserts (inlay) color: brushed steel, black, brushed gold and OAK CLASSIC CPL with a width of 8 mm or 50 mm flush with the door leaf surface, present on both sides of the door leaf, pp. 100-107

## HARDWARE

- three screw-in pin hinges in the rebated door leaf, silver or, for an extra charge, black
- two hinges (third for an extra charge) hidden in the non-rebated door leaf and two hinges (third for an extra charge) in the reversible leaf painted in silver (optionally for an extra charge in black, gold or white); hinges are supplied and priced with the frame
- latch-bolt lock in the rebated door leaf and magnetic lock in the non-rebated door leaf (optionally latch-bolt): for key, patent insert, economy or with lock in silver color (for an extra charge in black); optionally for an extra charge magnetic lock in black, gold or white
- magnetic lock in the reversible leaf: for key, patent insert, economy or with lock in silver color; optionally for an extra charge in black, gold or white

## PREMIUM

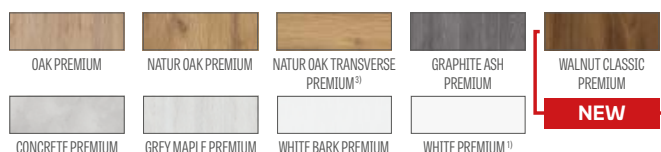

## AVAILABLE DOOR LEAF WIDTHS



## AVAILABLE SOLUTIONS (pp. 158-169)

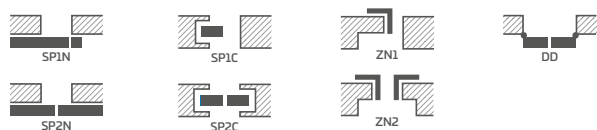

## EDGE FINISH TYPES



EDGE FINISH OF THE DOOR LEAF BLACK SMOOTH (at extra charge)



EDGE FINISH BLACK TRANSVERSE DOOR LEAF (at extra charge)



## EXTRA CHARGES

- reverse door leaf
- solid board filling
- reinforcement for door closer
- arm door closer (silver, black, white, brown)
- additional bottom beam (can be shortened by yourself up to max 8 cm)
- metal sleeves round and square (4 pcs.) finish: brushed nickel, patina, white and black
- wood-like plastic sleeves (4 pcs.)
- enhanced airflow trim standard or mini, ventilation undercut standard or mini (p. 153) or ventilation grille
- rebated and non-rebated door leaf "100"
- rebated and non-rebated door leaf "110"
- drop-down seal
- metal caps for hinges in rebated door leaves (brushed nickel, patina, gloss chrome, gloss brass, white, and black)
- change to hinges, strike plate and lock in black color for rebated door leaves
- stainless steel porthole: polished "chrome" or brushed "satin" and black matt; decormat milky glass, clear glass, porthole diameter: int. 235 mm ext. 350 mm)
- black door leaf edge finish
- change to magnetic lock in black, white or gold for non-rebated and reversible door leaves
- change to hinges and strike plate in black, white or gold for non-rebated door leaves
- internal wooden stile (sides and top, bottom MDF)
- LUX inlay; versions to choose from pp. 100-107
- standard PL2112 + 15% to the price of the door leaf before surcharges

<sup>1)</sup> smooth white laminate imitating a painted surface

<sup>3)</sup> in the set, the frame is made in NATUR OAK PREMIUM decor

<sup>4)</sup> only for non-rebated and reverse door leaves

<sup>5)</sup> while stocks last



# ALTAMURA

INTERIOR DOOR LEAVES: REBATED, NON-REBATED, AND REVERSIBLE



ALTAMURA 1 in RETRO CPL decor, with QUANTA FIT handle black matt, with black matt porthole



ALTAMURA 1



ALTAMURA 2



ALTAMURA 3



ALTAMURA 4



middle panel



ALTAMURA 5



ALTAMURA 6



ALTAMURA 7



ALTAMURA 8

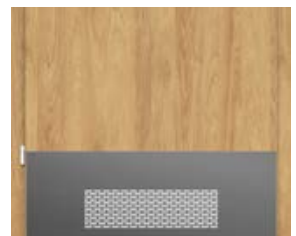

grid panel

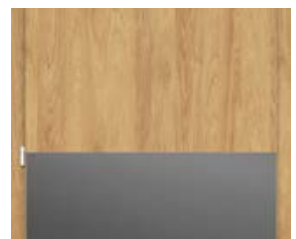

bottom panel

## DESIGN

- rebated, reverse, or non-rebated door leaf
- internal MDF frame covered with two HDF boards
- optional, for an additional fee, internal wooden stile (sides and top, bottom MDF) covered with two HDF boards
- stabilizing "honeycomb" filling or, for an extra charge, solid board filling
- optional, with extra charges: door frame extension panels and a crosshead with pilasters, pp. 155-157.
- possibility to shorten the door leaf on your own, details p. 153

## FINISH

- HDF board covered with laminate
- leaf edge made with STANDARD technology
- CPL laminates 0.2 and 0.7 available only with STANDARD edge, which is finished with ABS edging only in the color of the door leaf or, for an extra charge, with standard black edging
- edge (standard or non-rebated finish) finished with edging in the color of the surface or optionally in smooth black (in NATUR OAK TRANSVERSE PREMIUM decor, black edging with transverse structure)
- for ALTAMURA 1, double-sided inserts (inlay) available for an extra charge as indicated on pp. 100-107

## HARDWARE

- three screw-in pin hinges in the rebated door leaf, silver or, for an extra charge, black
- two hinges (third available for an extra charge) concealed in the non-rebated door leaf and two hinges in the reverse door leaf (third available for an extra charge) painted in silver (optionally for an extra charge in black, gold, or white); hinges are supplied and priced with the frame
- latch-bolt lock in the rebated door leaf and magnetic lock in the non-rebated door leaf (optionally latch-bolt): for key, patent insert, economy or with lock in silver color (for an extra charge in black); optionally for an extra charge magnetic lock in black, gold or white
- magnetic lock in the reversible leaf: for key, patent insert, economy or with lock in silver color; optionally for an extra charge in black, gold or white

## GLAZING

- **standard: tempered decormat glass - milky**, transparent or, for an extra charge, VSG 221 milky safety glass smooth on both sides
- possibility to change the glazing side to REVERSE (OBVERSE is standard glazing), p. 154

## EXTRA CHARGES

**reverse door leaf** (not available in CPL 0.2 and 0.7)

solid board filling

reinforcement for door closer

arm door closer (silver, black, white, brown)

additional bottom beam (can be shortened by the user to max 8 cm)

enhanced airflow trim standard or mini, ventilation undercut standard or mini (p. 153) or ventilation grille

metal sleeves, round or square (4 pcs.), finish: brushed nickel, patina, white and black

plastic sleeves

rebated and non-rebated door leaf "100" rebated and non-rebated door leaf "110"

laminated glass VSG 221 frosted pane

drop-down seal

metal caps for hinges in rebated door leaf (brushed nickel, patina, polished chrome, polished brass, white and black)

change to hinges, strike plate and lock in black color for rebated door leaves

in the ALTAMURA 1 model, available porthole in stainless steel: polished chrome or brushed satin and matt black; decormat milky glass, clear glass, porthole diameter: int. 235 mm ext. 350 mm)

stainless steel panel (mounted on both sides only for STANDARD rebated door leaves) height 300mm

– bottom ALTAMURA 1, 3, 4, 6, 8

– middle ALTAMURA 1, 4

– bottom with ventilation ALTAMURA 1, 3, 4, 6, 8

black door leaf edge finish

change to magnetic lock in black, white or gold for non-rebated and reversible door leaves

change to hinges and strike plate in black, white or gold for non-rebated door leaves

internal wooden stile (sides and top, bottom MDF)

in the ALTAMURA 1 model, LUX inlay; versions to choose from p. 100-107

standard PL2112

+ 15% to the price of the door leaf before surcharges

## GREKO



## CPL



## PREMIUM

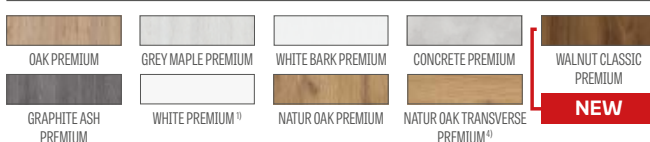

## AVAILABLE DOOR LEAF WIDTHS NEW



## AVAILABLE SOLUTIONS (pp. 158-169)



## TYPES OF EDGE FINISHES



## GLAZING FRAME



<sup>1)</sup> smooth white laminate imitating a painted surface

<sup>3)</sup> special **AntiFinger** coating reducing dirt and fingerprints

<sup>4)</sup> in the set, the frame is made in NATUR OAK PREMIUM decor

<sup>5)</sup> only for non-rebated and reverse door leaves

<sup>6)</sup> only ALTAMURA 1 non-rebated and reverse

<sup>7)</sup> while stocks last



# ANSEDONIA

INTERIOR DOOR LEAVES: REBATED, NON-REBATED, AND REVERSIBLE



ANSEDONIA 4 in GREY OAK ST CPL decor, with TOPAZ inox handle



ANSEDONIA 1



ANSEDONIA 2



ANSEDONIA 3



ANSEDONIA 4



ANSEDONIA 5



ANSEDONIA 6



ANSEDONIA 7



ANSEDONIA 8



ANSEDONIA 9



ANSEDONIA 10



ANSEDONIA 11



ANSEDONIA 12

## DESIGN

- rebated, reverse, or non-rebated door leaf
- internal MDF frame covered with two HDF boards
- optional, for an additional fee, internal wooden stile (sides and top, bottom MDF) covered with two HDF boards
- stabilizing "honeycomb" filling or, for an extra charge, solid board filling
- optional, with extra charges: door frame extension panels and a crosshead with pilasters, pp. 155-157.
- possibility to shorten the door leaf on your own, details p. 153

## FINISH

- HDF board covered with laminate
- door leaf edge made with STANDARD technology
- CPL laminates 0.2 and 0.7 available only with STANDARD edge, which is finished with ABS edging only in the color of the door leaf or, for an extra charge, with standard black edging
- edge (standard or non-rebated finish) finished with edging in the color of the surface or optionally in smooth black (in NATUR OAK TRANSVERSE PREMIUM decor, black edging with transverse structure)

## HARDWARE

- three screw-in pin hinges in the rebated door leaf, silver or, for an extra charge, black
- two hinges (third available for an extra charge) concealed in the non-rebated door leaf and two hinges in the reverse door leaf (third available for an extra charge) painted in silver (optionally for an extra charge in black, gold, or white); hinges are supplied and priced with the frame
- latch-bolt lock in the rebated door leaf and magnetic lock in the non-rebated door leaf (optionally latch-bolt): for key, patent insert, economy or with lock in silver color (for an extra charge in black); optionally for an extra charge magnetic lock in black, gold or white
- magnetic lock in the reversible leaf: for key, patent insert, economy or with lock in silver color; optionally for an extra charge in black, gold or white

## GLAZING

- **standard: tempered decormat glass - milky**, transparent or, for an extra charge, VSG 221 milky safety glass smooth on both sides
- possibility to change the glazing side to REVERSE (OBVERSE is standard glazing), p. 154

## EXTRA CHARGES

### reverse door leaf

(not available in CPL 0.2 and 0.7)

solid board filling

reinforcement for door closer

arm door closer (silver, black, white, brown)

additional bottom beam (can be shortened by the user to max 8 cm)

enhanced airflow trim standard or mini, ventilation undercut standard or mini (p. 153) or ventilation grille

plastic sleeves

metal sleeves, round or square (4 pcs.), finish: brushed nickel, patina, white and black

rebated and non-rebated door leaf "100"

laminated glass VSG 221, milky glass smooth on both sides

drop-down seal

metal caps for hinges in rebated door leaf (brushed nickel, patina, polished chrome, polished brass, white and black)

change to hinges, strike plate and lock in black color for rebated door leaves

black door leaf edge finish

change to magnetic lock in black, white or gold for non-rebated and reversible door leaves

change to hinges and strike plate in black, white or gold for non-rebated door leaves

internal wooden stile (sides and top, bottom MDF)

standard PL2112

+ 15% to the price of the door leaf before surcharges

## AVAILABLE DOOR LEAF WIDTHS NEW

60 65 70 75 80N<sup>5)</sup> 80 85 90 95 100

## GREKO

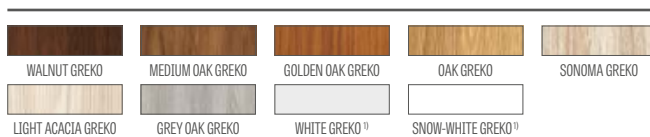

## CPL

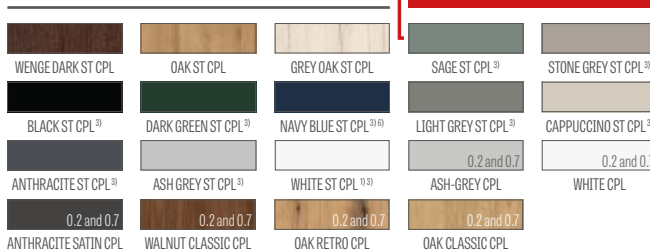

## PREMIUM

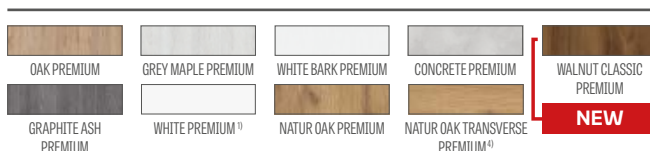

## AVAILABLE SOLUTIONS (pp. 158-169)

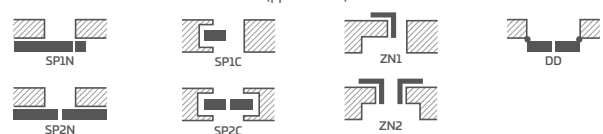

## TYPES OF EDGE FINISHES



## GLAZING FRAME



<sup>1)</sup> smooth white laminate imitating a painted surface

<sup>3)</sup> special **AntiFinger** coating reducing dirt and fingerprints

<sup>4)</sup> in the set, the frame is made in NATUR OAK PREMIUM decor

<sup>5)</sup> only for non-rebated and reverse door leaves

<sup>6)</sup> while stocks last



# LORIENT

INTERIOR DOOR LEAVES: REBATED, NON-REBATED, AND REVERSIBLE



LORIENT 1 in ANTHRACITE ST CPL decor, with TOPAZ inox handle



LORIENT 1



LORIENT 2



LORIENT 3



LORIENT 4



LORIENT 5



LORIENT 6



LORIENT 7



LORIENT 8



LORIENT 9



LORIENT 10



LORIENT 11



LORIENT 12

## DESIGN

- rebated, reverse, or non-rebated door leaf
- internal MDF frame covered with two HDF boards
- optional, for an additional fee, internal wooden stile (sides and top, bottom MDF) covered with two HDF boards
- stabilizing "honeycomb" filling or, for an extra charge, solid board filling
- optional, with extra charges: door frame extension panels and a crosshead with pilasters, pp. 155-157.
- possibility to shorten the door leaf on your own, details p. 153

## FINISH

- HDF board covered with laminate
- door leaf edge made with STANDARD technology
- edge (standard or non-rebated finish) finished with edging in the color of the surface or optionally in smooth black (in NATUR OAK TRANSVERSE PREMIUM decor, black edging with transverse structure)

## HARDWARE

- three screw-in pin hinges in the rebated door leaf, silver or, for an extra charge, black
- two hinges (third available for an extra charge) concealed in the non-rebated door leaf and two hinges in the reverse door leaf (third available for an extra charge) painted in silver (optionally for an extra charge in black, gold, or white); hinges are supplied and priced with the frame
- latch-bolt lock in the rebated door leaf and magnetic lock in the non-rebated door leaf (optionally latch-bolt): for key, patent insert, economy or with lock in silver color (for an extra charge in black); optionally for an extra charge magnetic lock in black, gold or white
- magnetic lock in the reversible leaf: for key, patent insert, economy or with lock in silver color; optionally for an extra charge in black, gold or white

## GLAZING

- **as standard, tempered decormat glass - frosted**, clear or for an extra charge VSG 221 frosted safety glass smooth on both sides
- possibility to change the glazing side to REVERSE (OBVERSE is standard glazing), p. 154

## EXTRA CHARGES

reverse door leaf
solid board filling
reinforcement for door closer
arm door closer (silver, black, white, brown)
additional bottom beam (can be shortened by the user to max 8 cm)
enhanced airflow trim standard or mini, ventilation undercut standard or mini (p. 153) or ventilation grille
plastic sleeves
metal sleeves, round or square (4 pcs.), finish: brushed nickel, patina, white and black
rebated and non-rebated door leaf "100"
laminated glass VSG 221 frosted glass smooth on both sides
drop-down seal
metal caps for hinges in rebated door leaf (brushed nickel, patina, polished chrome, polished brass, white and black)
change to hinges, strike plate and lock in black color for rebated door leaves
black door leaf edge finish
change to magnetic lock in black, white or gold for non-rebated and reversible door leaves
change to hinges and strike plate in black, white or gold for non-rebated door leaves
internal wooden stile (sides and top, bottom MDF)
standard PL2112 + 15% to the price of the door leaf before surcharges

## GREKO

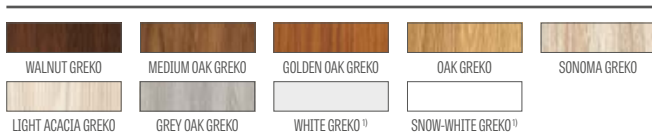

## CPL

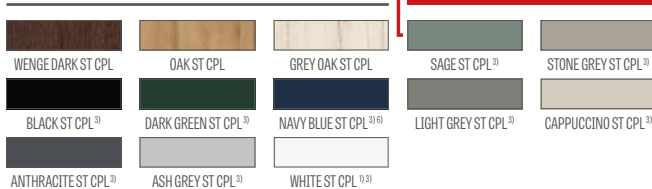

## PREMIUM

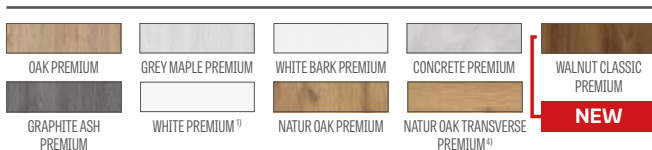

## AVAILABLE DOOR LEAF WIDTHS NEW



## AVAILABLE SOLUTIONS (pp. 158-169)

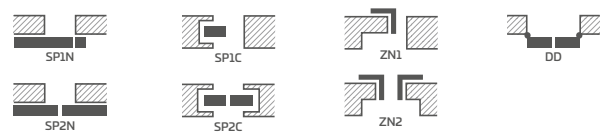

## TYPES OF EDGE FINISHES



## GLAZING FRAME

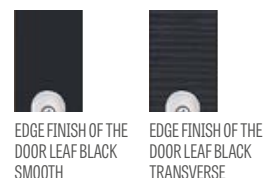

<sup>1)</sup> smooth white laminate imitating a painted surface

<sup>3)</sup> special **AntiFinger** coating limiting dirt and fingerprints

<sup>4)</sup> in the set, the frame is made in NATUR OAK PREMIUM decor

<sup>5)</sup> only for non-rebated and reverse door leaves

<sup>6)</sup> while stocks last



# MENTON

INTERIOR DOOR LEAVES: REBATED, NON-REBATED, AND REVERSIBLE



MENTON 1 in WALNUT CLASSIC CPL decor, with TOPAZ inox handle



MENTON 1



MENTON 2



MENTON 3



MENTON 4



MENTON 5



MENTON 6



MENTON 7



MENTON 8



MENTON 9



MENTON 10



MENTON 11



MENTON 12

## DESIGN

- rebated, reverse, or non-rebated door leaf
- internal MDF frame covered with two HDF boards
- optional, for an additional fee, internal wooden stile (sides and top, bottom MDF) covered with two HDF boards
- stabilizing "honeycomb" filling or, for an extra charge, solid board filling
- optional, with extra charges: door frame extension panels and a crosshead with pilasters, pp. 155-157.
- possibility to shorten the door leaf on your own, details p. 153

## FINISH

- door leaf edge made with STANDARD technology
- CPL laminates 0.2 and 0.7 available only with STANDARD edge, which is finished with ABS edging only in the color of the door leaf or, for an extra charge, with standard black edging
- edge (standard or non-rebated finish) finished with edging in the color of the surface or optionally in smooth black (in NATUR OAK TRANSVERSE PREMIUM decor; black edging with transverse structure)

## HARDWARE

- three screw-in pin hinges in the rebated door leaf, silver or, for an extra charge, black
- two hinges (third available for an extra charge) concealed in the non-rebated door leaf and two hinges in the reverse door leaf (third available for an extra charge) painted in silver (optionally for an extra charge in black, gold, or white); hinges are supplied and priced with the frame
- latch-bolt lock in the rebated door leaf and magnetic lock in the non-rebated door leaf (optionally latch-bolt): for key, patent insert, economy or with lock in silver color (for an extra charge in black); optionally for an extra charge magnetic lock in black, gold or white
- magnetic lock in the reversible leaf: for key, patent insert, economy or with lock in silver color; optionally for an extra charge in black, gold or white

## GLAZING

- **standard: tempered decormat glass - milky**, transparent or, for an extra charge, VSG 221 milky safety glass smooth on both sides
- possibility to change the glazing side to REVERSE (OBVERSE is standard glazing), p. 154

## EXTRA CHARGES

### reverse door leaf

(not available in CPL 0.2 and 0.7)

solid board filling

reinforcement for door closer

arm door closer (silver; black, white, brown)

additional bottom beam (can be shortened by the user to max 8 cm)

enhanced airflow trim standard or mini, ventilation undercut standard or mini (p. 153) or ventilation grille

metal sleeves, round or square (4 pcs.), finish: brushed nickel, patina, white and black

plastic sleeves

rebated and non-rebated door leaf "100"

laminated glass VSG 221 frosted pane

drop-down seal

metal caps for hinges in rebated door leaf (brushed nickel, patina, polished chrome, polished brass, white and black)

change to hinges, strike plate and lock in black color for rebated door leaves

black door leaf edge finish

change to magnetic lock in black, white or gold for non-rebated and reversible door leaves

change to hinges and strike plate in black, white or gold for non-rebated door leaves

internal wooden stile (sides and top, bottom MDF)

standard PL2112

+ 15% to the price of the door leaf before surcharges

## AVAILABLE DOOR LEAF WIDTHS

NEW

60 65 70 75 80N<sup>5)</sup> 80 85 90 95 100

## GREKO



## CPL



## PREMIUM

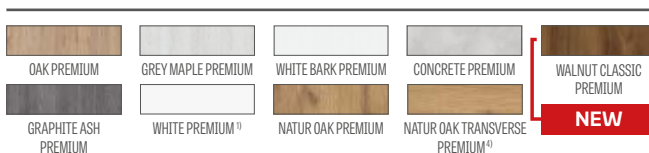

## AVAILABLE SOLUTIONS (pp. 158-169)

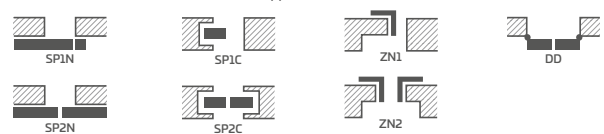

## TYPES OF EDGE FINISHES



## GLAZING FRAME



<sup>1)</sup> smooth white laminate imitating a painted surface

<sup>3)</sup> special **AntiFinger** coating reducing dirt and fingerprints

<sup>4)</sup> in the set, the frame is made in NATUR OAK PREMIUM decor

<sup>5)</sup> only for non-rebated and reverse door leaves

<sup>6)</sup> while stocks last



# SORANO

INTERIOR DOOR LEAVES: REBATED, NON-REBATED, AND REVERSIBLE



SORANO 1 in WENGE DARK ST CPL decor, with TOPAZ inox handle



SORANO 1



SORANO 2



SORANO 3



SORANO 4



SORANO 5



SORANO 6



SORANO 7



SORANO 8



SORANO 9



SORANO 10



SORANO 11



SORANO 12

## DESIGN

- rebated, reverse, or non-rebated door leaf
- internal MDF frame covered with two HDF boards
- optional, for an additional fee, internal wooden stile (sides and top, bottom MDF) covered with two HDF boards
- stabilizing "honeycomb" filling or, for an extra charge, solid board filling
- optional, with extra charges: door frame extension panels and a crosshead with pilasters, pp. 155-157.
- possibility to shorten the door leaf on your own, details p. 153

## FINISH

- door leaf edge made with STANDARD technology
- CPL laminates 0.2 and 0.7 available only with STANDARD edge, which is finished with ABS edging only in the color of the door leaf or, for an extra charge, with standard black edging
- edge (standard or non-rebated finish) finished with edging in the color of the surface or optionally in smooth black (in NATUR OAK TRANSVERSE PREMIUM decor; black edging with transverse structure)

## HARDWARE

- three screw-in pin hinges in the rebated door leaf, silver or, for an extra charge, black
- two hinges (third available for an extra charge) concealed in the non-rebated door leaf and two hinges in the reverse door leaf (third available for an extra charge) painted in silver (optionally for an extra charge in black, gold, or white); hinges are supplied and priced with the frame
- latch-bolt lock in the rebated door leaf and magnetic lock in the non-rebated door leaf (optionally latch-bolt): for key, patent insert, economy or with lock in silver color (for an extra charge in black); optionally for an extra charge magnetic lock in black, gold or white
- magnetic lock in the reversible leaf: for key, patent insert, economy or with lock in silver color; optionally for an extra charge in black, gold or white

## GLAZING

- as standard, **tempered decormat glass - frosted**, clear or for an extra charge VSG 221 frosted safety glass smooth on both sides
- possibility to change the glazing side to REVERSE (OBSERVE is standard glazing), p. 154

## EXTRA CHARGES

**reverse door leaf**  
(not available in CPL 0.2 and 0.7)

solid board filling

reinforcement for door closer

arm door closer (silver; black, white, brown)

additional bottom beam (can be shortened by the user to max 8 cm)

enhanced airflow trim standard or mini, ventilation undercut standard or mini (p. 153) or ventilation grille

metal sleeves, round or square (4 pcs.), finish: brushed nickel, patina, white and black

plastic sleeves

rebated and non-rebated door leaf "100"

laminated glass VSG 221 frosted pane

drop-down seal

metal caps for hinges in rebated door leaf (brushed nickel, patina, polished chrome, polished brass, white and black)

change to hinges, strike plate and lock in black color for rebated door leaves

black door leaf edge finish

change to magnetic lock in black, white or gold for non-rebated and reversible door leaves

change to hinges and strike plate in black, white or gold for non-rebated door leaves

internal wooden stile (sides and top, bottom MDF)

standard PL2112

+ 15% to the price of the door leaf before surcharges

## AVAILABLE DOOR LEAF WIDTHS NEW

60 65 70 75 80N<sup>5)</sup> 80 85 90 95 100

## GREKO



## CPL

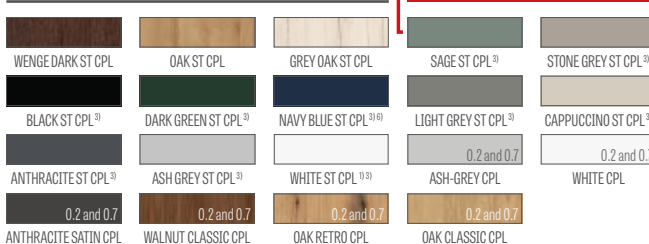

## PREMIUM

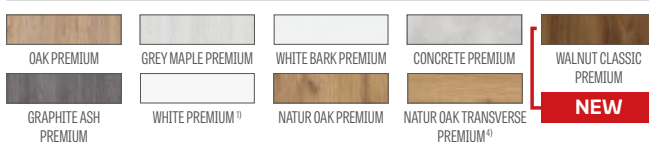

## AVAILABLE SOLUTIONS (pp. 158-169)

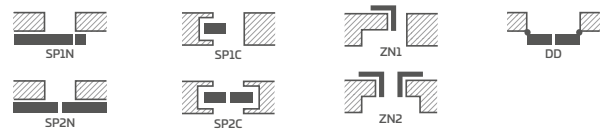

## TYPES OF EDGE FINISHES



## GLAZING FRAME



<sup>1)</sup> smooth white laminate imitating a painted surface

<sup>3)</sup> special **AntiFinger** coating reducing dirt and fingerprints

<sup>4)</sup> in the set, the frame is made in NATUR OAK PREMIUM decor

<sup>5)</sup> only for non-rebated and reversible door leaves

<sup>6)</sup> while stocks last



# FORTECA RC2 and RC3

REBATED BURGLARY-RESISTANT DOORS IN RC2 AND RC3 CLASS OPENING INWARD OR OUTWARD



FORTECA RC3 in LIGHT GREY ST CPL decor; with LUX 220 inlay



2 hook bolts



Top and bottom anti-burglary lock



Four strike plates with adjustment

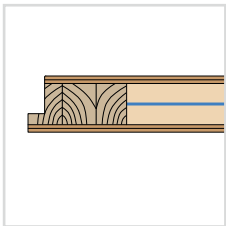

46 mm door leaf reinforced with steel sheet

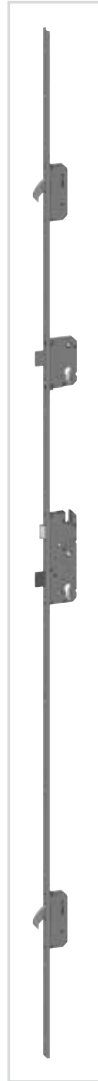

Multipoint lock



38dB



4 two-pin hinges Ø16 with 3D adjustment



4 anti-pry bolts



Fixed door frame wooden in RC2 or reinforced in RC3



Threshold made of hardwood (clear lacquer)



CERTUS RC2 handle



CERTUS RC3 handle



Peephole



Stainless steel threshold

### FORTECA DOOR LEAF CROSS-SECTION

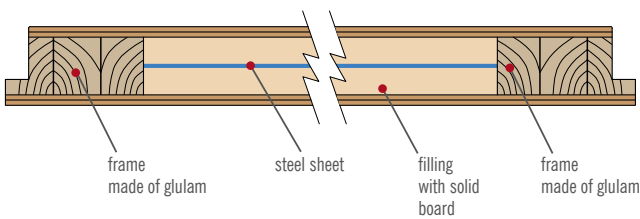

### THRESHOLD MADE OF HARDWOOD

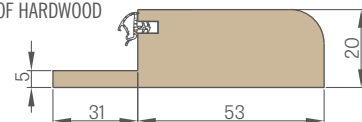

### THRESHOLD MADE OF STAINLESS STEEL SHEET

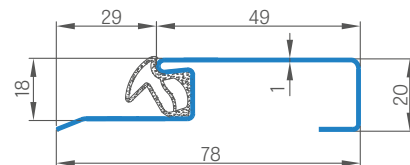



# FORTECA RC2 and RC3

REBATED BURGLARY-RESISTANT DOORS IN RC2 AND RC3 CLASS OPENING INWARD OR OUTWARD



FORTECA RC2 and RC3 in OAK CLASSIC CPL decor



FORTECA RC2 in NATUR OAK PREMIUM decor, with RC2 anti-burglary handle in black matt

FORTECA RC 2		
GOLD PACKAGE	SILVER PACKAGE	DOOR LEAF <sup>1)</sup>

FORTECA RC 3		
GOLD PACKAGE	SILVER PACKAGE	DOOR LEAF <sup>1)</sup>

**RC2 – important information:**

In order to maintain RC2 burglary resistance class according to PN-EN 1627:2012, the applied hardware should meet the following requirements:

- at least class 2 according to PN-EN 1906:2012 – for handles and door escutcheons,
- at least class 4 and 1 according to PN-EN 1303:2015 – for cylinder inserts.

**RC3 – important information:**

In order to maintain RC3 burglary resistance class according to PN-EN 1627:2012, the applied hardware should meet the following requirements:

- at least class 3 according to PN-EN 1906:2012 – for handles and door escutcheons,
- at least class 4 and 1 according to PN-EN 1303:2015 – for cylinder inserts.

<sup>1)</sup> used only in sets with steel frame p. 127

## GENERAL INFORMATION

- FORTECA anti-burglary doors opening outwards or inwards have acoustic insulation at the level of  $R_w=38$  dB, anti-burglary class RC2 or RC3 according to PN EN 1627:2012 and 5th class of mechanical durability.
- Doors available in GOLD and SILVER packages with optional casing and with steel frame.
- We use the doors as internal entrance doors.

## DESIGN

- wooden frame covered with glued HDF boards
- filled with a specialized solid board
- reinforcement of the entire door leaf with a steel plate
- door leaf thickness 46 mm

## FINISH

- door leaf edge made in STANDARD technology (in laminates CPL 0.2 and 0.7 covered with ABS edging only in the color of the door leaf or optionally with standard black edging for a surcharge)
- inserts (inlay) color: brushed steel, black, brushed gold and OAK CLASSIC CPL, width 8 mm or 50 mm flush with the surface of the door leaf, available on both sides of the door leaf, p. 100-107
- edge covered with edging in the color of the door leaf or optionally in smooth black (in NATUR OAK TRANSVERSE PREMIUM decor; black edging with transverse structure)
- HDF board covered with GREKO, PREMIUM, CPL laminate
- side and top panels glued to the wall (only with frame with wall casing and 8 cm clip angle) – p. 156 and integrated panels with frame p. 157

## HARDWARE

- four silver two-pin hinges  $\varnothing 16$  with 3D adjustment (2D with steel frame)
- four-point anti-burglary strip hook lock as standard for two cylinders
- four anti-pry bolts on the hinge side
- possibility to use an arm door closer
- lower lock spacing 92 mm

## FIXED REBATED FRAME

- fixed wooden door frame covered with MDF boards. In FORTECA RC3, internally reinforced on the strike plate side with a steel angle bar.
- possibility of casing in the range of 90-450 mm every 40 mm
- adjustable main strike in the frame and two adjustable strikes for hooks and additional lock

## GOLD PACKAGE / GOLD black

- FORTECA doors in the GOLD PACKAGE are fully assembled with a mounted steel or wooden threshold, with a strip lock and have holes for installing an anti-burglary handle and upper escutcheon. They are equipped with a peephole (hole to be made by the user) and certified anti-burglary handles and cylinders in silver color or, for an extra charge, black in the GOLD package with black finish.

## SILVER PACKAGE

- FORTECA doors in the SILVER PACKAGE are fully assembled with a mounted steel or wooden threshold and with a strip lock. We recommend ordering the peephole and certified hardware from the ERKADO offer or from an external company on your own, keeping in mind the important information regarding maintaining anti-burglary conditions (p. 124).

## AVAILABLE DOOR LEAF WIDTHS

80N 80 90E 100

- **GOLD PACKAGE / GOLD black** door leaf with fixed wooden frame, stainless steel threshold and fittings in silver color or, for an extra charge, black in the GOLD package with black finish
- **SILVER PACKAGE** door leaf with fixed wooden frame, stainless steel threshold, without fittings

## SURCHARGE

surcharge for GOLD package in black finish

– RC 2

– RC 3

“100” door

black door leaf edge finish

handle spacing 92 mm with upper escutcheon for RC 2 doors, silver or black color (class 2 according to PN-EN 1906:2012)

handle spacing 92 mm with cylinder protection and upper escutcheon for RC3 doors, silver or black color (class 3 according to PN-EN 1906:2012)

set of two cylinders (one with knob) in one-key system for RC2 and RC3 doors (class 4 and 1 according to PN-EN 1303:2015)

peephole

– nickel

– black

metal hinge covers: brushed nickel, patina, polished chrome, polished brass, white and black

shortening the door leaf with wooden frame up to 8 cm and steel frame up to 6 cm, every 1 cm

LUX inlay; versions to choose from pp. 100-107

arm door closer (silver, black, white, brown)

## GREKO



## CPL

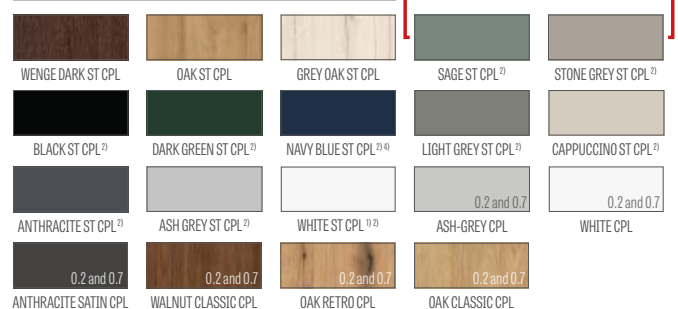

## PREMIUM

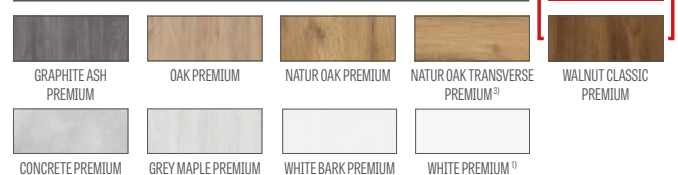

<sup>1)</sup> smooth white laminate imitating a painted surface

<sup>2)</sup> special **AntiFinger** coating limiting dirt and fingerprints

<sup>3)</sup> in the set, the frame is made in the NATUR OAK PREMIUM decor

<sup>4)</sup> while stocks last

# FIXED DOOR FRAME

FORTECA

## FORTECA RC3 FIXED FRAME DIAGRAM

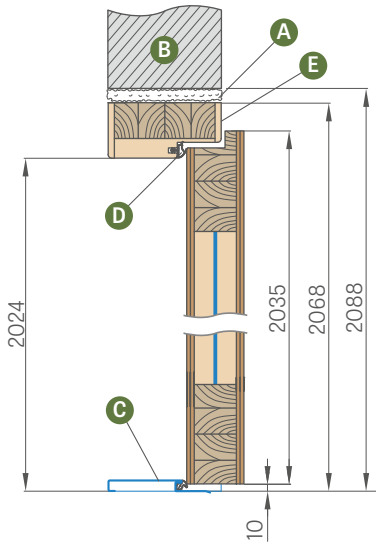

### WALL CASING every 40 mm

(does not include the angle bar with clips, which is available at extra cost)

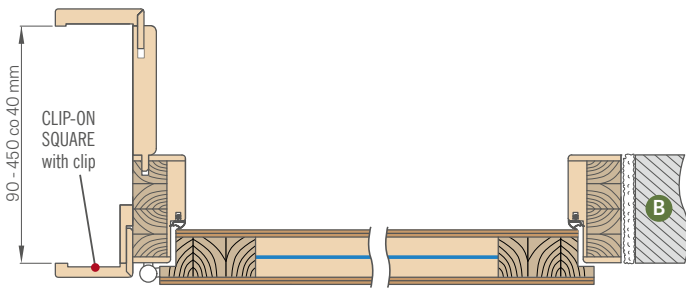

In a frame with ranges: 90-130 mm and 130-170 mm, the tongue of the angle bar must be cut to the required range by yourself.

Range (mm)	GREKO	PREMIUM and ST CPL	CPL 0.2
90-130 130-170			
170-210 210-250			
250-290 290-330 330-370 370-410 410-450			

Wall casing comes with an internal angle bar of 6 cm or 8 cm and, optionally for an extra charge, with an external angle bar of 6 cm or 8 cm on a clip with a trim or quarter round. Casing is used only for GOLD and SILVER packages.

### EXTRA CHARGES

connection at a 90-degree angle

clip-on square with clips 60 mm or 80 mm (clip-on square with three clips allows for an additional 20 mm of adjustment range)

shortening the door with wooden frame to 8 cm every 1 cm

available side and top panels glued to the wall and integrated panels with the frame (only with casing frame and 8 cm angle bar)

strip and quarter round

- A - mounting foam
- B - wall
- C - threshold made of stainless steel or wood
- D - rubber gasket
- E - additional internal reinforcement of the frame with a steel angle bar on the strike plate side (only in the frame for Forteca RC3)

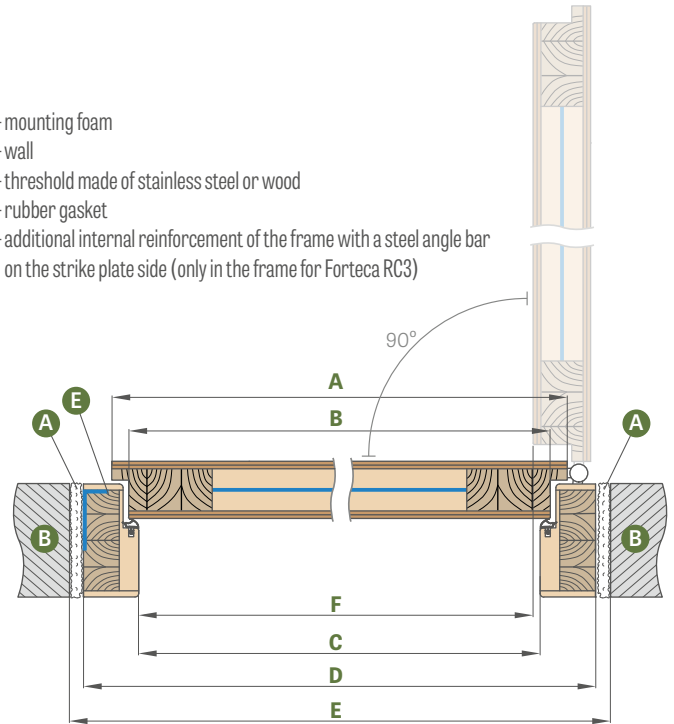

Door width	A	B	C	D	E	F
"80N"	804	778	764	852	892	759
"80"	848	822	808	896	936	803
"90E"	948	922	908	996	1036	903
"100"	1048	1022	1008	1096	1136	1003

"90E" - investment width

### FIXED DOOR FRAME

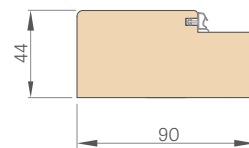

### COVER PROFILE

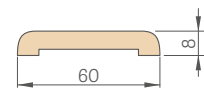

### CLIP-ON SQUARE 6 cm and 8 cm

with clips

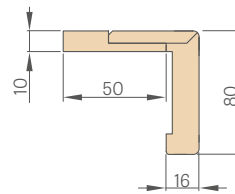

### QUARTER ROUND

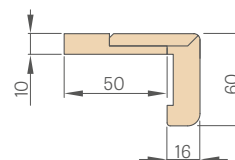
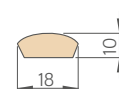

# STEEL DOOR FRAMES

FORTECA

## ADJUSTABLE STEEL DOOR FRAME (OVERLAPPING)

welded and painted in RAL 9003, 9010, 9016, 8003, 8017, 7016, 7022, 9005, 7047, 1001

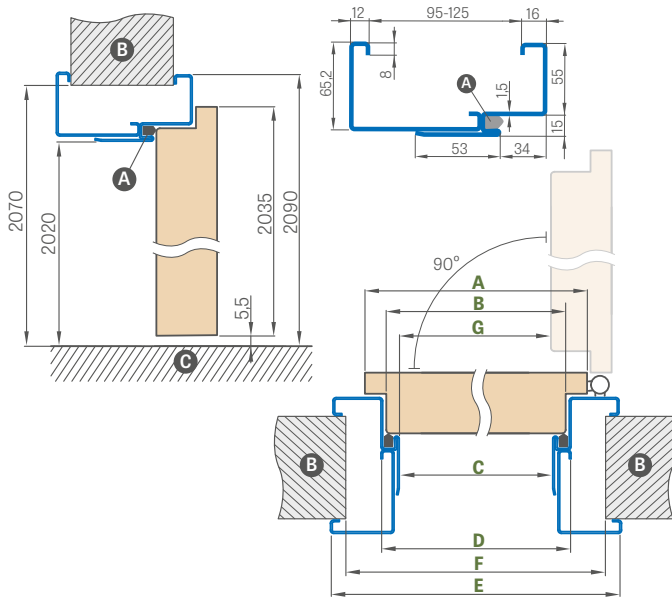

Door width	A	B	C	D	E	F	G
"80N"	804	778	761	791	901	865	754,5
"80"	848	822	805	835	945	910	798,5
"90ES"	960	934	917	947	1057	1022	910
"100" <sup>1)</sup>	1048	1022	1005	1035	1145	1110	998,5

"90ES" - investment width for steel frame

## LARGE SQUARE STEEL FRAME

welded and painted in RAL 9003, 9010, 9016, 8003, 8017, 7016, 7022, 9005, 7047, 1001

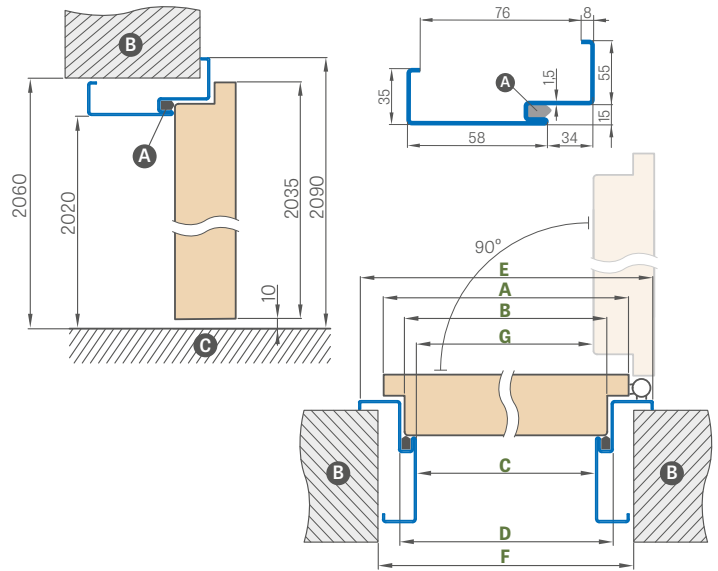

Door width	A	B	C	D	E	F	G
"80N"	804	778	761	791	901	840	754,5
"80"	848	822	805	835	945	885	798,5
"90ES"	960	934	917	947	1057	997	910
"100" <sup>1)</sup>	1048	1022	1005	1035	1145	1085	998,5

FORTECA RC2 ADJUSTABLE STEEL DOOR FRAME		
Adjustment range min.-max (mm)	"80N", "80", "90ES"	"100"
95-125		
125-155		
155-185		
185-215		
215-245		
245-275		
275-305		
305-335		
335-365		

FORTECA RC3 ADJUSTABLE STEEL DOOR FRAME		
Adjustment range min.-max (mm)	"80N", "80", "90ES"	"100"
95-125		
125-155		
155-185		
185-215		
215-245		
245-275		
275-305		
305-335		
335-365		

## FITTING THE SQUARE FRAME

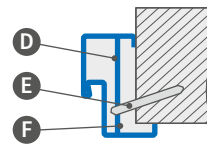

- A - gasket
- B - wall
- C - floor
- D - mounting anchor
- E - anchor bolt
- F - fill

## EXTRA CHARGES

large angle frame "100"

reinforcement for door closer

stainless steel threshold

shortening the door with a steel frame to 6 cm every 1 cm

galvanised sheet steel

+10%

non-typical RAL (does not include rare, intense, pearlescent, and metallic colours)

+10%

## RAL



RAL 9003<sup>1)</sup> RAL 9010 RAL 9016 RAL 8003 RAL 8017 RAL 7016 RAL 7022<sup>1)</sup> RAL 9005<sup>1)</sup> RAL 7047 RAL 1001

<sup>1)</sup> at extra charge +10%

# HERSE SET and MAX SET ECO 30dB

HERSE SET and MAX SET 32 dB HERSE SET and MAX SET ACOUSTIC 39 dB  $U_d \leq 1.3 \text{ W/m}^2\text{K}$

ENTRANCE DOORS WITH ANTI-BURGLARY LOCKS OR STRIP LOCK

HERSE SET in the WALNUT CLASSIC CPL decor, with ESSEN handle



## GENERAL INFORMATION

- HERSE SET and MAX SET doors are intended for public utility and residential buildings as internal entrance doors (does not apply to width "80N").
- The HERSE SET and MAX SET door leaf with fixed and adjustable door frame and with each available threshold has acoustic insulation at the level of  $R_w = 30 \text{ dB}$  or, for an extra charge,  $R_w = 32 \text{ dB}$  and  $R_w = 39 \text{ dB}$ .
- HERSE SET and MAX SET doors in the AKUSTIC 39 dB version, PL standard for widths "90E" or "100", may have, for an extra charge, a heat transfer coefficient  $U_d \leq 1.3 \text{ W/m}^2\text{K}$  (does not apply to the version with steel frame)
- HERSE SET and MAX SET doors in GOLD and SILVER PACKAGES are fully assembled with a mounted threshold, and in the GOLD package have drilling for handle and escutcheon installation.
- HERSE MAX SET doors are available only in PREMIUM decors: ORZECH, GREY MAPLE, OAK, WHITE BARK, GRAPHITE ASH, CONCRETE, NATURAL OAK, CROSS NATURAL OAK, WALNUT CLASSIC PREMIUM

## DESIGN

- wooden stile for  $R_w = 32 \text{ dB}$  and  $R_w = 39 \text{ dB}$  or MDF for  $R_w = 30 \text{ dB}$  covered with two HDF boards
- Filled with a specialized solid board
- reinforcement with a massive steel channel  $R_w = 30 \text{ dB}$  and  $R_w = 32 \text{ dB}$  and additionally a steel plate for  $R_w = 39 \text{ dB}$
- door leaf thickness 46 mm
- additional gasket in the door leaf only for  $R_w = 32 \text{ dB}$  and  $R_w = 39 \text{ dB}$

## FINISH

- door leaf edge made in STANDARD technology
- CPL laminates 0.2 and 0.7 available in STANDARD edge, which is finished with ABS edging only in the color of the door leaf or, for an extra charge, with standard black edging (not available for HERSE MAX SET)
- inserts (inlay) color: brushed steel, black, brushed gold, brushed copper, and OAK CLASSIC CPL with a width of 8 mm or 50 mm flush with the surface of the door leaf, present on both sides of the door leaf, pp. 100-107 (not available for HERSE MAX SET)
- STANDARD edge finished with edging in the color of the door leaf or optionally in smooth black (in the NATUR OAK TRANSVERSE PREMIUM decor, black edging with cross structure)
- factory shortening up to 8 cm available for an extra charge
- possibility to order only with bottom lock
- side and top panels glued to the wall (only with adjustable door frame with 8 cm angle bar) – p. 156 and integrated panels with frame p. 157

## HARDWARE

- three silver 2-pin hinges  $\varnothing 16$  with 3D adjustment (2D with steel frame)
- two three-bolt anti-burglary locks class 2 for patent cylinder (optionally only bottom lock included in the price)
- three anti-pry bolts on the hinge side
- possibility to use an arm door closer
- bottom lock spacing 72 mm
- optionally, for an extra charge, strip bolt lock for two cylinders available

## FIXED AND ADJUSTABLE REBATED FRAME

- fixed wooden door frame for  $R_w = 32 \text{ dB}$  and  $R_w = 39 \text{ dB}$  or MDF for  $R_w = 30 \text{ dB}$
- possibility to use electric strike in frames only for bottom lock, which excludes the use of upper lock in the door leaf.
- main strike with adjustment in frames
- width 80N available only on fixed frame
- in GOLD and SILVER packages for PREMIUM and CPL decors, possibility to change frame color to BLACK ST CPL

## AVAILABLE DOOR LEAF WIDTHS

80N	80	90E <sup>9)</sup>	90ES <sup>10)</sup>	100
-----	----	-------------------	---------------------	-----

HERSE SET ECO 30dB		
GOLD PACKAGE	SILVER PACKAGE	DOOR LEAF
		GREKO
		PREMIUM / ST CPL
		CPL 0.2
		CPL 0.7

HERSE MAX SET ECO 30dB		
GOLD PACKAGE	SILVER PACKAGE	DOOR LEAF
		PREMIUM <sup>9)</sup>

## EXTRA CHARGE FOR DOORS

HERSE SET 32 dB (added to GOLD and SILVER packages or door leaf)

HERSE SET AKUSTIC 39 dB  
(added to GOLD and SILVER packages or door leaf)

## GOLD PACKAGE

Door leaf with fixed frame, stainless steel threshold and fittings<sup>5) 6)</sup>

## SILVER PACKAGE

Door leaf with fixed frame, stainless steel threshold, without fittings<sup>5) 6)</sup>

## EXTRA CHARGES

GOLD package in black finish

silver peephole  
black peephole

threshold made of hard wood (clear lacquer) with gasket width 55 mm or stainless steel threshold with gasket

threshold made of hard wood (clear lacquer) for adjustable door frame

arm door closer (silver, black, white, brown)

reinforcement for door closer

drop-down seal

shortening of the door leaf with wooden frame to 8 cm and steel frame to 6 cm every 1 cm or product according to CZ standard

black door leaf edge finish

door leaf or package "100"

cylinder 30/45

- silver  
- black

knob-cylinder 30G/45 or 30/45G silver  
knob-cylinder 30G/45 or 30/45G black

cylinder 30/45 and knob-cylinder 30G/45 or 30/45G in one key system

- silver  
- black

metal hinge covers: brushed nickel, patina, polished chrome, polished brass, white and black

ESSEN handle (satin nickel, patina, black)<sup>6)</sup>

ESSEN upper escutcheon (satin nickel, patina, black)<sup>6)</sup>

LUX inlay; versions to choose from pp. 100-107

extra charge for HERSE SET AKUSTIC 39 dB door  
(added to GOLD and SILVER packages or door leaf)

extra charge for HERSE ACOUSTIC 39 dB door version Ud <= 1.3 W/m<sup>2</sup>K PL standard

extra charge for HERSE SET 32 dB door  
(added to GOLD and SILVER packages or the door leaf)

clip-on square with clips, 3 pcs. (allows for an additional 20 mm of adjustment range)

multi-point bolt strip lock (pin) with two locks<sup>7)</sup>

factory drilling for peephole 500 mm from the upper edge of the door leaf<sup>12)</sup>; does not apply to HERSE AKUSTIK

## TYPES OF EDGE FINISHES



STANDARD

## MOULDING

(applies to HERSE MAX SET)

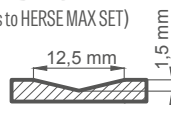

<sup>1)</sup> smooth white laminate imitating a painted surface

<sup>3)</sup> special **AntiFinger** coating reducing dirt and fingerprints

<sup>4)</sup> in the set, the frame is made in NATUR OAK PREMIUM decor

<sup>5)</sup> hardware set: ESSEN handle Nickel satin, upper escutcheon, cylinders in one-key system (upper with knob), peephole (without drilled hole) in silver color or for an extra charge in black color

<sup>6)</sup> ESSEN handles and escutcheons cannot be used with the strip lock

<sup>7)</sup> when using a multi-point bolt strip lock, it is not possible to install the ESSEN handle

<sup>8)</sup> decors in which HERSE MAX SET is available

<sup>9)</sup> door leaf width for fixed or adjustable door frame

<sup>10)</sup> door leaf width for steel frame

<sup>11)</sup> while stocks last

## GREKO

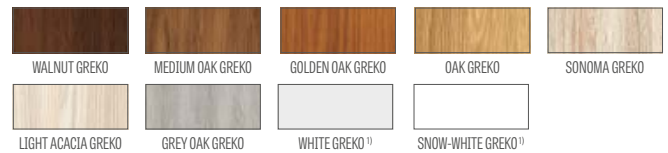

## CPL



## PREMIUM



# HERSE MAX SET



HERSE MAX SET 23



HERSE MAX SET 26



HERSE MAX SET 30



HERSE MAX SET 31

# FIXED AND ADJUSTABLE DOOR FRAME

HERSE SET, HERSE MAX SET

## FIXED FRAME DIAGRAM HERSE SET

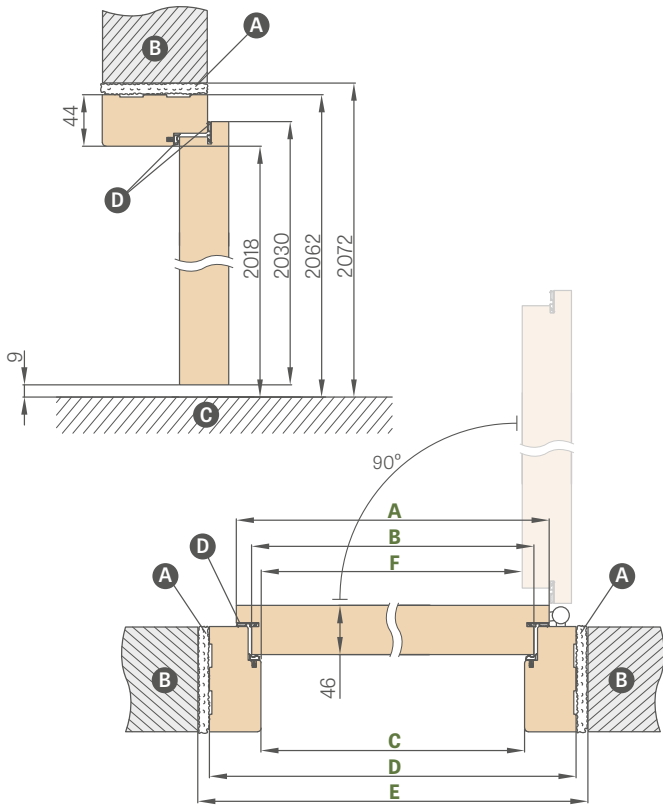

## ADJUSTABLE FRAME DIAGRAM HERSE SET

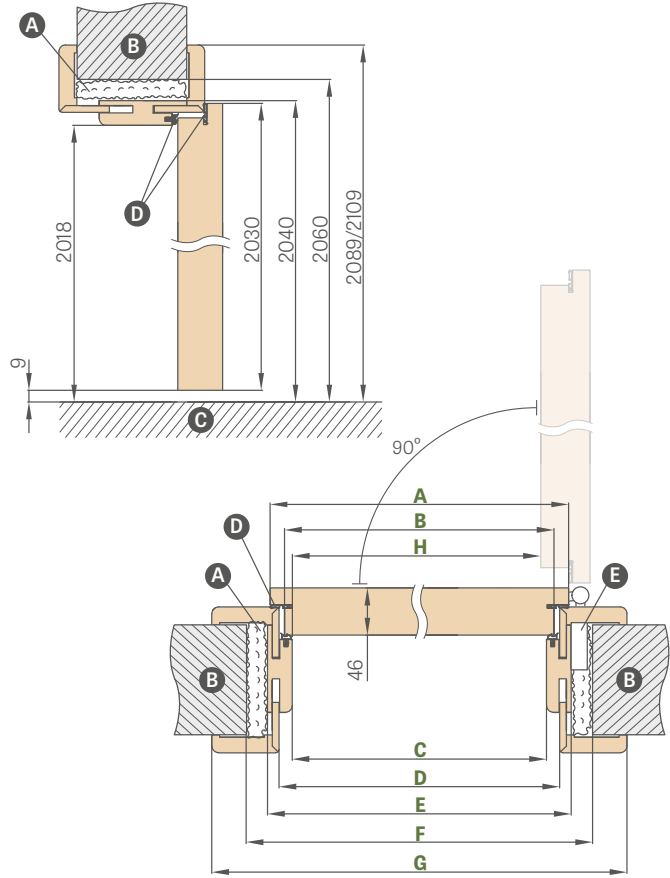

Door width	A	B	C	D	E	F
"80N"	804	777	764	852	872	756
"80"	844	817	804	892	912	796
"90E"	948	921	908	996	1016	900
"100"	1044	1017	1004	1092	1112	996

Door width	A	B	C	D	E	F	G	H
"80"	844	817	804	826	848	888	946*/986**	796
"90E"	948	921	908	930	952	992	1050*/1090**	900
"100"	1044	1017	1004	1026	1048	1088	1146*/1186**	996

\* architrave 6 cm / \*\* architrave 8 cm

"90E" - investment width

- Ⓐ - mounting foam
- Ⓑ - wall
- Ⓒ - floor
- Ⓓ - gasket (for  $R_w = 30\text{dB}$  only in the frame, for  $R_w = 32\text{dB}$  and  $R_w = 39\text{dB}$  in the frame and the door leaf)
- Ⓔ - strike socket

## ADJUSTABLE FRAME ADJUSTMENT RANGE

architrave 6 cm / architrave 8 cm

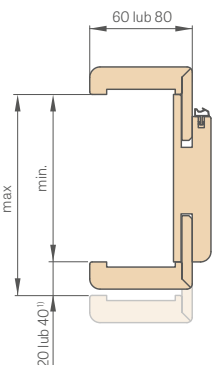

## ADJUSTABLE WOODEN THRESHOLD

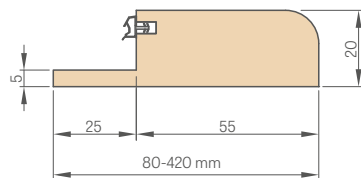

## FIXED DOOR FRAME

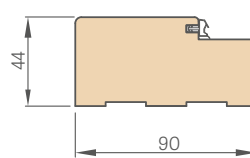

## BAND COVERING

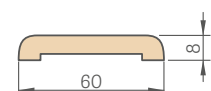

## CLIP-ON SQUARE 6 cm and 8 cm

with clips

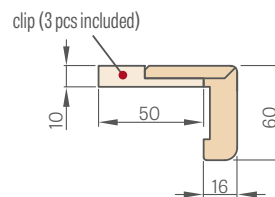
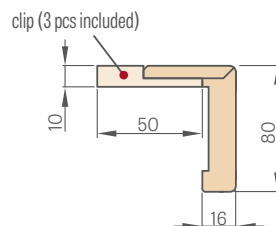

## QUARTER ROUND

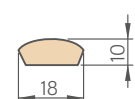

<sup>1)</sup> 40 mm for range 280-320 mm

## PRICES OF FIXED AND ADJUSTABLE FRAMES

Adjustment range min.-max (mm)	HERSE SET, HERSE LUX SET and HERSE MAX SET band 6 and 8 cm			
	GREKO all GREKO decors	PREMIUM and ST CPL all PREMIUM and ST CPL decors	CPL 0.2	THRESHOLDS FOR ADJUSTABLE FRAMES MADE OF HARDWOOD (clear lacquer)
1 element	80-100			
	100-120			
	120-140			
	140-160			
	160-180			
	180-200			
	200-220			
	220-240			
	240-260			
	260-280			
2 elements	280-300			
	300-340			
	340-360			
	360-380			
	380-400			
	400-420			

FIXED DOOR FRAME HERSE SET, HERSE LUX SET, HERSE MAX SET			
	GREKO all GREKO decors	PREMIUM and ST CPL all decors PREMIUM and ST CPL	CPL 0.2
FIXED DOOR FRAME			
TRIM			
QUARTER ROUND			-

### HARDWOOD THRESHOLD CLEAR LACQUER FIXED 55 mm



Hardwood threshold  
natural



Hardwood threshold  
painted in black,  
visible wood structure  
(at extra charge)



Hardwood threshold  
painted in brown,  
visible wood structure  
(at extra charge)



Hardwood threshold  
painted in graphite color (RAL 7024), no  
visible wood structure (at extra charge)

- **AquaStop** hybrid waterproof adjustable door frame (available in PL and CZ standards only in ST CPL and PREMIUM decors and only for architrave 8 cm joined at a 45-degree angle – extra charge)
- Hardwood threshold (fixed and adjustable door frames) in the following colors: black, brown, graphite (RAL 7024) – 20% surcharge
- Frames in CPL 0.2 are also used in sets with door leaves in CPL 0.7
- Door frame joints at a 90-degree angle are only possible with door frames with an architrave 8 cm. Extra charges for door frame joints at a 90-degree angle<sup>1)</sup>
- Electric door strike – extra charge
- Reinforcement for door closer for adjustable door frame – extra charge
- Clip-on SQUARE with three clips (Clip-on SQUARE with clips allows for a 20 mm increase in the adjustment range for a fixed door frame) – extra charge (CPL 0.2, AquaStop ST CPL, and PREMIUM – extra charge)
- Trim and quarter round<sup>1)</sup>
- Available side and top panels glued to the wall (only with adjustable door frame and architrave 8 cm) – extra charge
- Shortening the door with a wooden frame to 8 cm every 1 cm or product in CZ standard – extra charge
- It is possible to make the frame and threshold from hardwood up to a range of 500-520 mm – extra charge for every 2 cm, based on the range 400-420 mm
- Change of range by +20 mm (available in ranges from 100-120 mm to 280-300 mm)<sup>1)</sup> – extra charge

<sup>1)</sup> not available in AquaStop frame



# STEEL DOOR FRAMES

HERSE SET, HERSE MAX SET

## ADJUSTABLE STEEL DOOR FRAME (OVERLAPPING) HERSE SET

welded and painted in RAL 9003, 9010, 9016, 8003, 8017, 7016, 7022, 9005, 7047, 1001

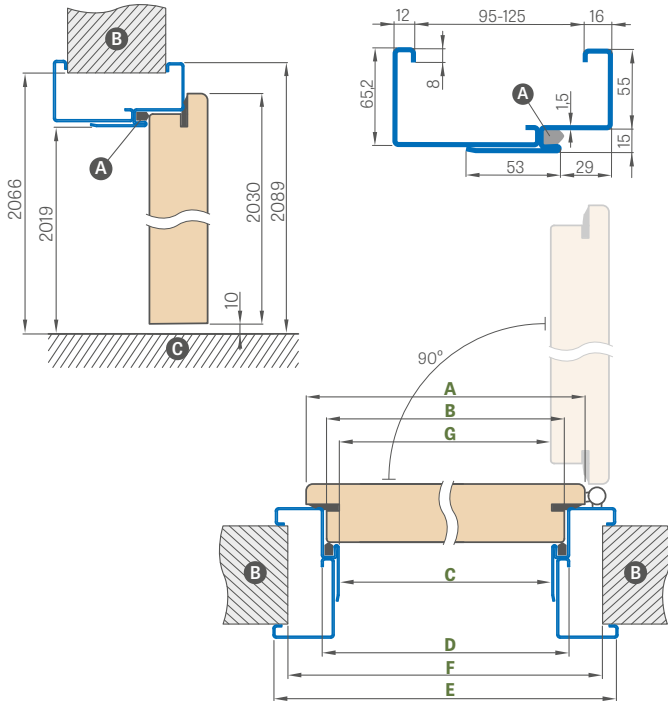

Door width	A	B	C	D	E	F	G
"80N"	804	777	761	791	901	855	756
"80"	844	817	801	831	941	895	796
"90ES"	948	921	905	935	1045	999	900
"100"	1044	1017	1001	1031	1141	1095	996

"90ES" - investment width for steel frame

Adjustment range min.-max (mm)	"80N", "80", "90ES"	"100" <sup>1)</sup>
95-125		
125-155		
155-185		
185-215		
215-245		
245-275		
275-305		

## LARGE SQUARE STEEL FRAME HERSE SET

welded and painted in RAL 9003, 9010, 9016, 8003, 8017, 7016, 7022, 9005, 7047, 1001

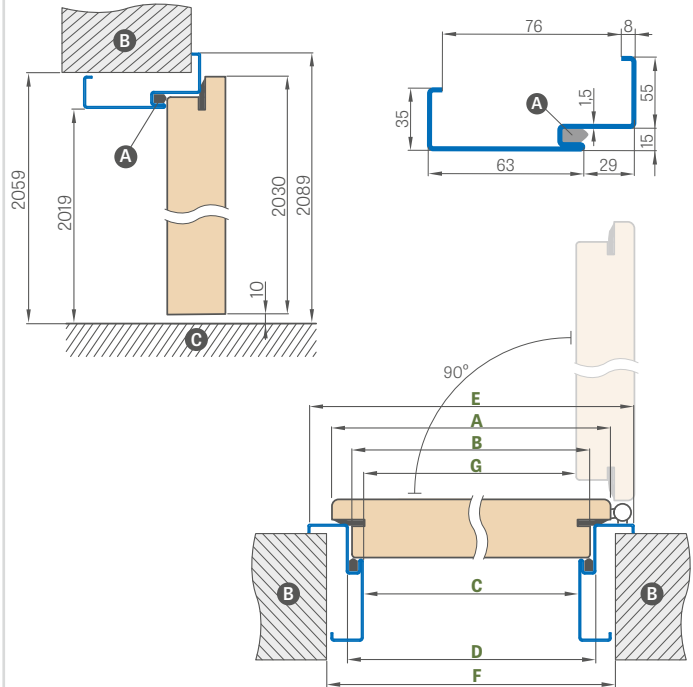

Door width	A	B	C	D	E	F	G
"80N"	804	777	761	791	901	841	756
"80"	844	817	801	831	941	881	796
"90ES"	948	921	905	935	1045	985	900
"100"	1044	1017	1001	1031	1141	1081	996

## FITTING THE SQUARE FRAME

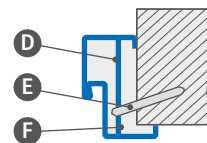

- A - gasket
- B - wall
- C - floor
- D - mounting anchor
- E - anchor bolt
- F - fill

## EXTRA CHARGES

- large angle frame "100" \_\_\_\_\_
- electric door strike \_\_\_\_\_
- reinforcement for door closer \_\_\_\_\_
- shortening the door leaf with steel frame to 6 cm every 1 cm \_\_\_\_\_
- stainless steel threshold \_\_\_\_\_
- galvanised sheet steel \_\_\_\_\_ +10%
- non-typical RAL (does not include rare, intense, pearlescent, and metallic colours) \_\_\_\_\_ +10%

## RAL



<sup>1)</sup> at extra charge +10%

# UNITED STEEL DOOR FRAME

HERSE SET, HERSE MAX SET

## UNITED STEEL DOOR FRAMES DIAGRAM

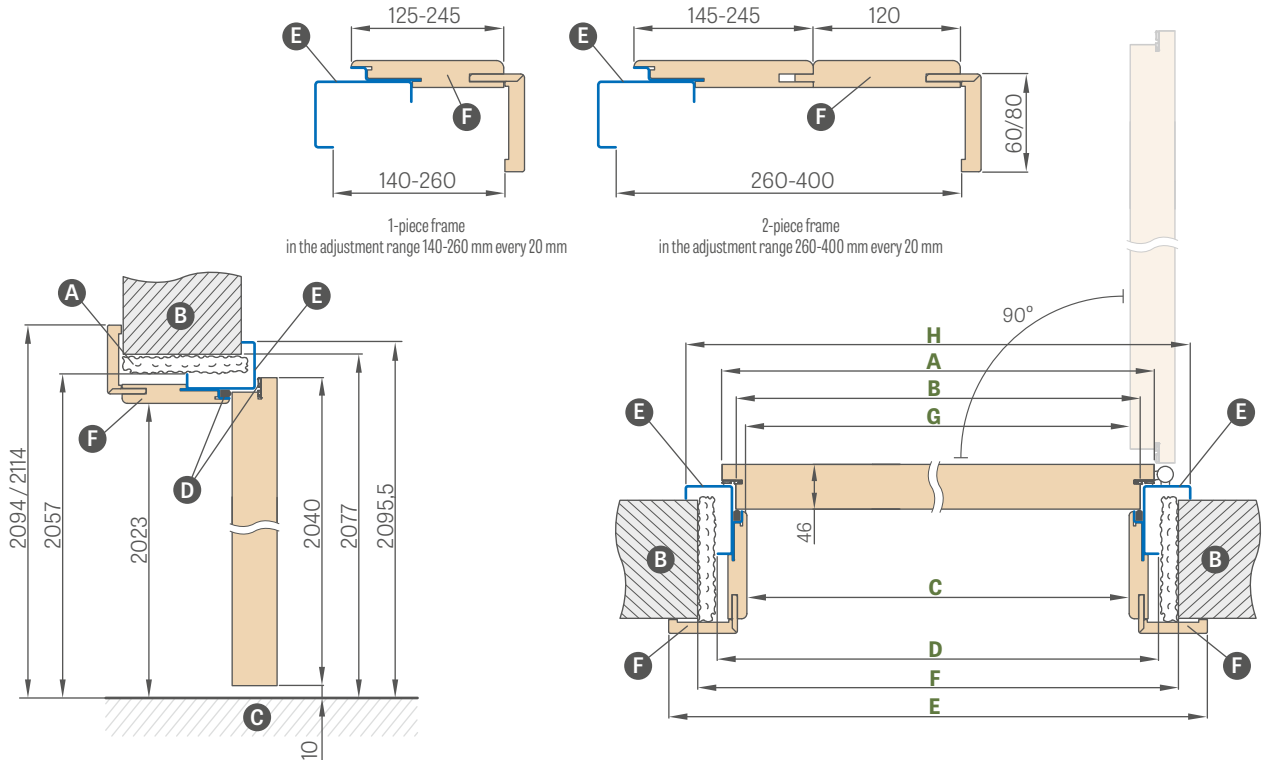

Door width	A	B	C	D	E	F	G	H
"80U"	844	817	791,5	859	933,5 / 973,5	899	790	935
"90EU"	960	933	907,5	975	1049,5 / 1089,5	1015	906	1051
"100U"	1044	1017	991,5	1059	1133,5 / 1173,5	1099	990	1135

"90EU" - investment width on UNITED steel frame

- A** - mounting foam
- B** - wall
- C** - floor
- D** - rubber gasket
- E** - steel part painted in RAL color
- F** - laminated MDF part

Adjustment range min.-max (mm)	UNITED STEEL DOOR FRAME (steel part painted in RAL)		
	GREKO	ST CPL and PREMIUM	CPL 0.2
140-160			
160-180			
180-200			
200-220			
220-240			
240-260			
260-280			
280-300			
300-320			
320-340			
340-360			
360-380			
380-400			

## EXTRA CHARGES

- electric door strike
- reinforcement for door closer
- shortening the door leaf with UNITED steel frame to 6 cm every 1 cm
- stainless steel threshold, height 20 mm
- galvanised sheet steel +10%
- non-typical RAL (does not include rare, intense, pearlescent, and metallic colours) +10%

## RAL



<sup>1)</sup> at extra charge +10%



# LEDA EI30, EI60

FIRE-RESISTANT INTERNAL ENTRANCE DOORS MADE WITH HALSPAN TECHNOLOGY



## DOOR LEAF WITH ADJUSTABLE STEEL FRAME (SURROUNDING)

Adjustment range min.-max (mm)	LEDA EI30 door leaf + adjustable steel frame			LEDA EI60 + door leaf, adjustable steel door frame		
	"80"	"90ES"	"100"	"80"	"90ES"	"100"
95-125						
125-155						
155-185						
185-215						
215-245						
245-275						
275-305						

"90ES" - investment width for steel frame

## DOOR LEAF WITH LARGE ANGLE STEEL FRAME

LEDA EI30 + door leaf, large steel angle frame			LEDA EI60 + door leaf, large steel angle frame		
"80"	"90ES"	"100"	"80"	"90ES"	"100"

"90ES" - investment width for steel frame

## DOOR LEAF WITH FIXED WOODEN FRAME

LEDA EI30 door leaf + fixed wooden frame			LEDA EI60 door leaf + fixed wooden frame		
"80"	"90E"	"100"	"80"	"90E"	"100"

## GREKO



## PREMIUM

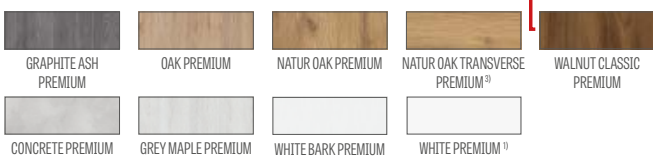

## CPL

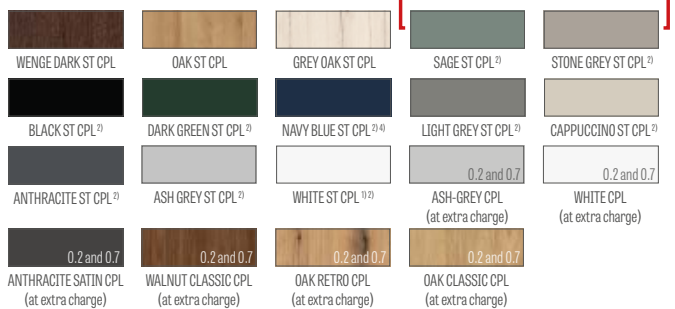

1) smooth white laminate imitating a painted surface  
 2) special **AntiFinger** coating limiting dirt and fingerprints  
 3) in the set, the frame is made in the NATUR OAK PREMIUM decor  
 4) while stocks last

## GENERAL INFORMATION

Fire-resistant, smoke-tight, and acoustic functions are ensured only by installing a complete set, which includes: fire-resistant door leaf (factory-equipped with seals, lock, hinges, drop seal), frame, door closer, and cylinder and handle meeting the requirements of the Polish Standard.

The acoustic insulation of HALSPAN system doors with a drop seal according to PN-B-02151-03:1999 is  $R_w=32$  dB

We sell the door leaves only as a set with a wooden or steel frame.

## DESIGN

- filled with a specialized HALSPAN board with a thickness of 44 mm for EI30 type and 54 mm for EI60
- total door leaf thickness 50 mm in EI30 and 60 mm in EI60
- frame made of softwood
- fire seal and intumescent smoke seal
- drop-down seal
- transparent fire-resistant glass, the width of the glass is fixed (independent) of the door leaf width.

## FINISH

- door leaf edge made in STANDARD technology (in CPL laminates 0.2 and 0.7) finished with ABS edging only in the color of the door leaf) or, for an extra charge, with standard black edging
- inserts (inlay) color: brushed steel, black, brushed gold, and OAK CLASSIC CPL with a width of 8 mm or 50 mm flush with the surface of the door leaf, present on both sides of the door leaf. Applies only to full LEDA. Types of inlays shown on pages 100-107
- double-sided inlay appears only on the full door leaf and in double-leaf doors on the active leaf
- edge finished with edging in the color of the door leaf or optionally in smooth black (in the NATUR OAK TRANSVERSE PREMIUM decor; black edging with a transverse structure)
- side and top panels glued to the wall (only with installation using an 8 cm angle bar) – p. 156

## HARDWARE

- four hinges  $\varnothing 16$  for LEDA EI30 adjustable in three planes (wooden frame)
- four hinges  $\varnothing 20$  for LEDA EI60 adjustable in three planes (wooden frame)
- four three-part hinges  $\varnothing 15$  for LEDA EI30 and EI60 with 2D adjustment (steel frame)
- lock for patent cylinder
- door closer for an extra charge

## FRAMES

- fixed wooden fire-resistant door frame
- fire seal
- strike plate with adjustment
- steel adjustable, large angled or fixed welded in RAL 9003, 9010, 9016, 8003, 8017, 7016, 7022, 7047, 1001
- steel frame made of black sheet metal 1.5 mm thick, powder-coated in RAL color; welded at the corners, with reinforcement for door closer as standard.

## EXTRA CHARGES

fire-rated arm door closer  
in colors: silver, black, white, brown

fire-rated rail door closer  
(only for frames without casing or with casing using an angle bar with a clip)  
in colors: silver, black, white, brown

fire ventilation grille

JOWISZ INOX handle, long escutcheon, cylinder p. 147

cylinder 30/40 (EI30) or 30/50 (EI60) (silver)

fire peephole, satin chrome color

metal hinge covers (matt chrome, black)<sup>2)</sup>

hinge painted black<sup>4)</sup>

fire latch-bolt upper lock

black door leaf edge finish

casing for EI30 from 100 to 460 and  
casing for EI60 from 120 to 480 every 40 mm  
double-leaf door casing

fire-rated fail-secure electric strike<sup>3)</sup> (standard) 12/24V (not applicable to steel frames)

non-standard RAL in steel frame (does not include intense, pearlescent and metallic colors)

steel frame made of galvanized sheet metal

EI30

Surcharge for glazing type 3  
Surcharge for glazing type 4  
Surcharge for glazing type 5, 7  
Surcharge for glazing type 6, 8

EI60

Surcharge for glazing type 4  
Surcharge for glazing type 6, 8

LUX inlay; versions to choose from p. 100-107 (double-sided only on the full door leaf and in double-leaf doors on the active leaf)

CPL 0.2 laminate (for doors without casing)

CPL 0.7 laminate (for doors without casing)

clip-on square with clips<sup>1)</sup> (Clip-on square with clips allows for an additional 20 mm of adjustment range)

surcharge for door leaf "110"

side and top panels glued to the wall (only with installation using an 8 cm angle bar)

<sup>1)</sup> The clip-on square is included in the price.

<sup>2)</sup> covers cannot be used with doors with a steel frame

<sup>3)</sup> electric strike cannot be used in double-leaf doors

<sup>4)</sup> available only for steel frame

# LEDA EI30, EI60

## SINGLE-LEAF DOOR

### FIXED WOODEN DOOR FRAME

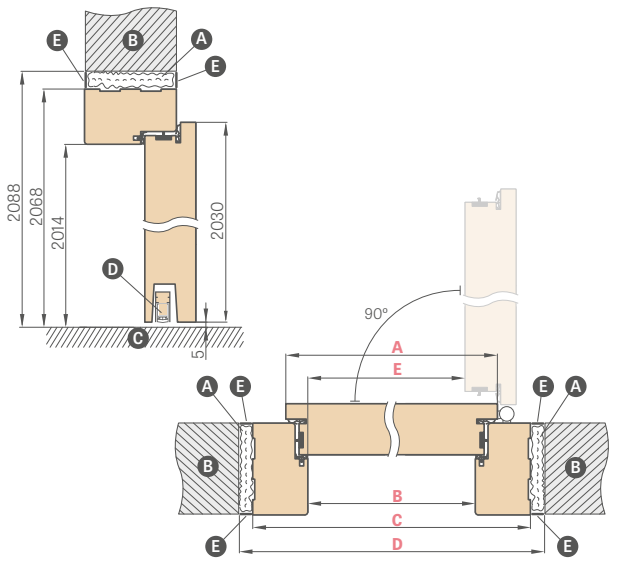

Door width	A	B	C	D	E
"80"	860	817	925	955	805
"90E"	960	917	1025	1055	905
"100"	1060	1017	1125	1155	1005
"110"	1160	1117	1225	1255	1105

- A** - mineral wool
- B** - wall
- C** - floor
- D** - drop-down seal
- E** - plaster mortar

"90E" - investment width

### ADJUSTABLE STEEL DOOR FRAME (OVERLAPPING) FIRE-RESISTANT

welded and painted in RAL 9003, 9010, 9016, 8003, 8017, 7016, 7022, 9005, 7047, 1001

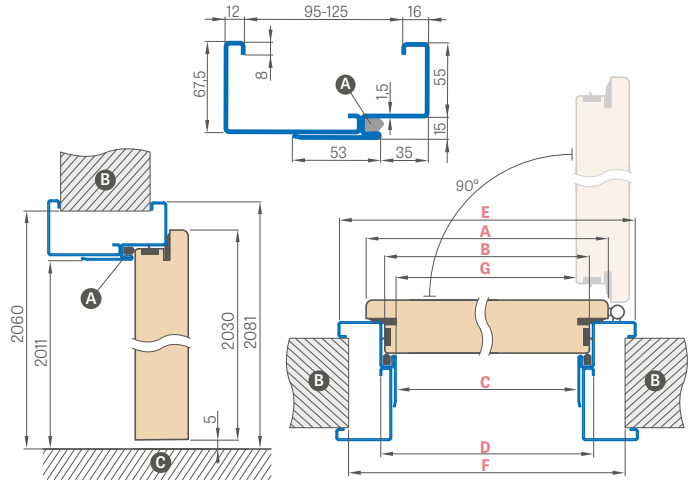

Door width	A	B	C	D	E	F	G
"80"	860	834	813	843	953	910	802
"90ES"	960	934	913	943	1053	1010	902
"100"	1060	1034	1013	1043	1153	1110	1002
"110"	1160	1134	1113	1143	1253	1210	1102

"90ES" - investment width for steel frame

### CROSS-SECTION OF FIRE-RATED FRAME WITH WALL CASING AND ANGLE BAR WITH CLIP

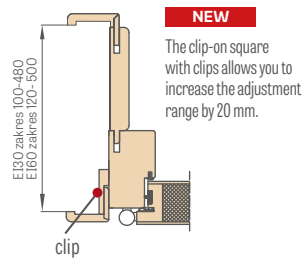

**NEW**  
The clip-on square with clips allows you to increase the adjustment range by 20 mm.

### CROSS-SECTION OF FIRE-RATED FRAME WITH BASIC WALL CONSTRUCTION

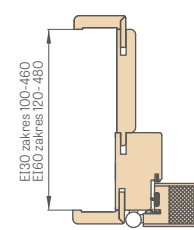

### CLIP-ON SQUARE 6 cm and 8 cm with clips

clip (3 pcs included)

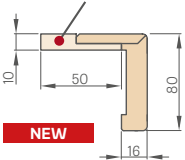

clip (3 pcs included)

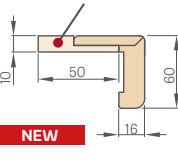

### CROSS-SECTION OF FIXED FIRE-RATED FRAME

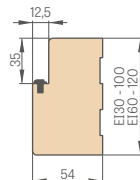

### LARGE SQUARE STEEL FRAME FOR FIRE PROTECTION

welded and painted in RAL 9003, 9010, 9016, 8003, 8017, 7016, 7022, 9005, 7047, 1001

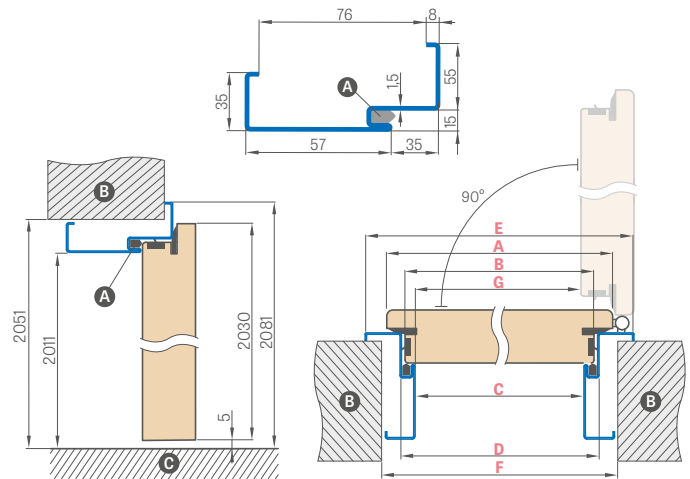

Door width	A	B	C	D	E	F	G
"80"	860	834	813	843	953	890	802
"90ES"	960	934	913	943	1053	990	902
"100"	1060	1034	1013	1043	1153	1090	1002
"110"	1160	1134	1113	1143	1253	1190	1102

### CLOSER TRACK TYPE <sup>1)</sup>



### CLOSER ARM TYPE



<sup>1)</sup> track type closer should be used only for fixed frames or for constructions with an angle bracket with a clip applied

<sup>2)</sup> with an extra charge of +10%

### RAL



RAL 9003<sup>2)</sup> RAL 9010 RAL 9016 RAL 8003 RAL 8017 RAL 7016 RAL 7022<sup>2)</sup> RAL 9005<sup>2)</sup> RAL 7047 RAL 1001

# LEDA EI30, EI60

## DOUBLE-LEAF DOORS



LEDA 3 "90E" + inactive door leaf "60"

LEDA 6 "90E" + inactive door leaf "80"

LEDA 4 "90E" + side panel "40"

### LEDA EI30 and EI60 DOUBLE-LEAF DOOR

- Double-leaf doors are made based on LEDA EI30 and EI60 models with their corresponding features: color; finish (STANDARD);
- The inactive door leaf is available in the following versions:
  - solid in widths "60", "70", "80"
  - glazed in types 5, 6, 7, 8 for EI30 and glazed in types 6 and 8 for EI60
- The side panel is available in widths "30", "40" and "50" and in each variant is available as a smooth solid door leaf;
- The inactive door leaf and the side panel are equipped with door bolts and catches, and do not have meeting stiles.

### AVAILABLE DOOR LEAF WIDTHS OF ACTIVE DOOR LEAVES DEPENDING ON THE TYPE OF FIRE-RATED DOOR

LEDA EI30 EI60 80 90E 100	LEDA glazing type 3 EI30 90E 100	LEDA glazing type 4 EI30 EI60 90E 100	LEDA glazing type 5 EI30 80 90E 100
LEDA glazing type 6 EI30 EI60 80 90E 100	LEDA glazing type 7 EI30 80 90E 100	LEDA glazing type 8 EI30 EI60 80 90E 100	

### AVAILABLE DOOR LEAF WIDTHS OF INACTIVE DOOR LEAVES DEPENDING ON THE TYPE OF FIRE-RATED DOOR

LEDA EI30 EI60 60 70 80	LEDA glazing type 5 EI30 70 80	LEDA glazing type 6 EI30 EI60 70 80
LEDA glazing type 7 EI30 70 80	LEDA glazing type 8 EI30 EI60 70 80	

### PRICE OF DOUBLE-LEAF DOORS

A sum consisting of:

- active part = price of single-leaf solid door plus any surcharges as for single-leaf doors
- inactive part = price for the solid version (also side panel) plus any surcharges as for single-leaf doors

### AVAILABLE DOOR LEAF WIDTHS

active door leaf **80 90E 100** + passive door leaf **60 70 80**  
 active door leaf **80 90E 100** + solid smooth side panel **30 40 50**

	FIRE DOOR DOUBLE-LEAF WOODEN FRAME								
	"110"	"120"	"130"	"140"	"150"	"160"	"170"	"180"	
<b>A</b> Width of active door leaf	860	860   960	860   960   1060	860   960   1060	860   960   1060	860   960   1060	960   1060	1060	
<b>B</b> Width of inactive leaf or side panel	347	447   347	547   447   347	647   547   447	747   647   547	847   747   647	847   747	847	
<b>C</b> Width in the frame opening	1170	1270	1370	1470	1570	1670	1770	1870	
<b>F</b> External width of the frame	1278	1378	1478	1578	1678	1778	1878	1978	
<b>E</b> Width of the wall opening	1310	1410	1510	1610	1710	1810	1910	2010	

### ADJUSTABLE STEEL DOOR FRAME (OVERLAPPING) FIRE-RESISTANT

welded and painted in RAL 9003, 9010, 9016, 8003, 8017, 7016, 7022, 7047, 1001

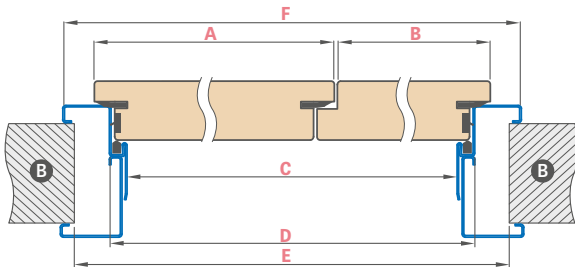

Door width	A	B	C	D	E	F
"110"	860	347	1166	1196	1270	1306
"120"	860   960	447   347	1266	1296	1370	1406
"130"	860   960   1060	547   447   347	1366	1396	1470	1506
"140"	860   960   1060	647   547   447	1466	1496	1570	1606
"150"	860   960   1060	747   647   547	1566	1596	1670	1706
"160"	860   960   1060	847   747   647	1666	1696	1770	1806
"170"	960   1060	847   747	1766	1796	1870	1906
"180"	1060	847	1866	1896	1970	2006

### LARGE SQUARE STEEL FRAME FOR FIRE PROTECTION

welded and painted in RAL 9003, 9010, 9016, 8003, 8017, 7016, 7022, 7047, 1001

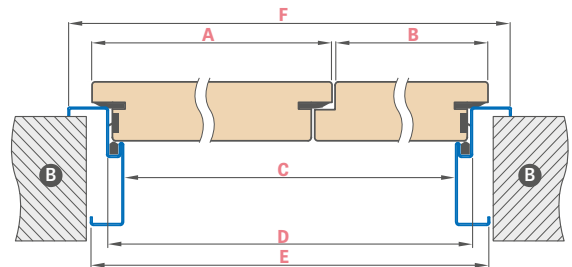

Door width	A	B	C	D	E	F
"110"	860	347	1166	1196	1236	1306
"120"	860   960	447   347	1266	1296	1336	1406
"130"	860   960   1060	547   447   347	1366	1396	1436	1506
"140"	860   960   1060	647   547   447	1466	1496	1536	1606
"150"	860   960   1060	747   647   547	1566	1596	1636	1706
"160"	860   960   1060	847   747   647	1666	1696	1736	1806
"170"	960   1060	847   747	1766	1796	1836	1906
"180"	1060	847	1866	1896	1936	2006



# HARDWARE

## HANDLES FOR PANEL AND STILE DOOR LEAVES

### NEW handles NOVA CLICK, TOPAZ CLICK

inox, black matt



**NOVA CLICK**  
inox



**NOVA CLICK**  
black matt



**TOPAZ CLICK**  
inox



**TOPAZ CLICK**  
black matt

NOVA CLICK and TOPAZ CLICK handles are available in LEFT and RIGHT versions, details on page 149

### NEW handle CORONA TIME SLIM R

matt brass, gunmetal, black matt



**CORONA TIME SLIM R**  
matt brass



**CORONA TIME SLIM R**  
gunmetal



**CORONA TIME SLIM R**  
black matt



HANDLE CLASS  
**PREMIUM**

### NEW handle CORONA IMPERA RT

shiny chrome, brushed matt chrome, shiny copper, brushed matt nickel, matt black, matt white



**CORONA IMPERA RT**  
shiny chrome



**CORONA IMPERA RT**  
brushed matt chrome



**CORONA IMPERA RT**  
shiny copper



**CORONA IMPERA RT**  
brushed matt nickel



**CORONA IMPERA RT**  
black matt



**CORONA IMPERA RT**  
matt white



HANDLE CLASS  
**PREMIUM**

HANDLES FOR PANEL AND STILE DOOR LEAVES



NEW

handle CORONA ARROW R

shiny chrome, brushed matt chrome, matt black, matt white



**CORONA ARROW R**  
shiny chrome



**CORONA ARROW R**  
brushed matt chrome



**CORONA ARROW R**  
black matt



**CORONA ARROW R**  
matt white

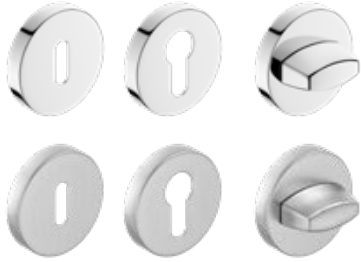

NEW

handle CORONA ARROW Q

shiny chrome, brushed matt chrome, matt white, matt black



**CORONA ARROW Q**  
shiny chrome



**CORONA ARROW Q**  
brushed matt chrome



**CORONA ARROW Q**  
black matt



**CORONA ARROW Q**  
matt white

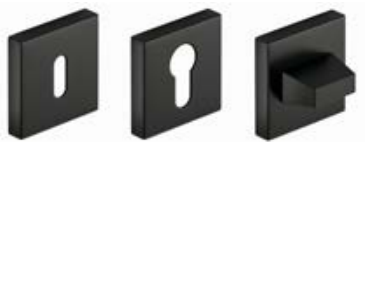
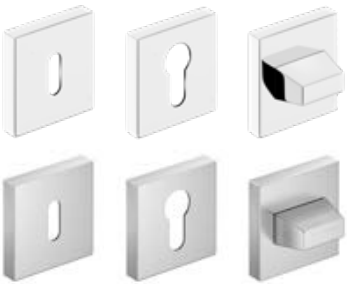

NEW

handle CORONA MOON R SLIM

shiny chrome, matt black, shiny brass, matt brass



**CORONA MOON R SLIM**  
shiny chrome



**CORONA MOON R SLIM**  
black matt



**CORONA MOON R SLIM**  
shiny brass



**CORONA MOON R SLIM**  
matt brass

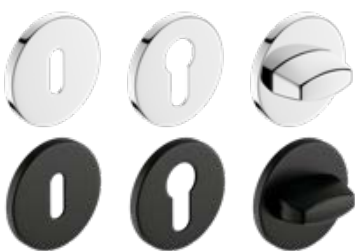



## HANDLES FOR PANEL AND STILE DOOR LEAVES

NEW

handles **QUANTA FIT**, **DIVA FIT**, **ZOJA FIT**, **TORA FIT** (prestigious 6 mm thick escutcheon)

**Metal-Bud**

PRODUCENT KLAMEK

shiny chrome, brushed nickel, brushed brass, matt black



**TORA FIT**  
black matt



**DIVA FIT**  
brushed nickel



**DIVA FIT**  
brushed brass



**DIVA FIT**  
black matt



**ZOJA FIT**  
brushed nickel



**ZOJA FIT**  
brushed brass



**ZOJA FIT**  
black matt



**QUANTA FIT**  
shiny chrome



**QUANTA FIT**  
brushed nickel

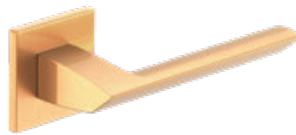

**QUANTA FIT**  
brushed brass



**QUANTA FIT**  
black matt

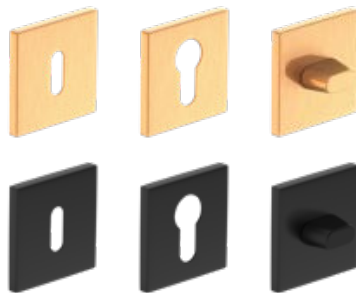

handle **BELLA SLIM SQUARE** (prestigious 6 mm thick escutcheon)

shiny chrome, brushed matt chrome, shiny brass, satin brass, matt black

**Metal-Bud**

PRODUCENT KLAMEK



**BELLA SLIM square**  
shiny chrome



**BELLA SLIM square**  
brushed matt chrome



**BELLA SLIM square**  
shiny brass



**BELLA SLIM square**  
satin brass



**BELLA SLIM square**  
black matt

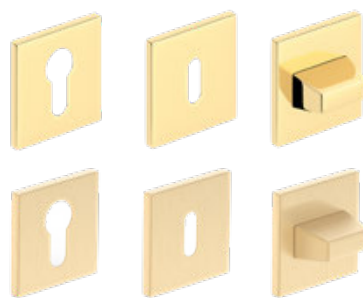

HANDLE CLASS  
**PREMIUM**

**HANDLES FOR PANEL AND STILE DOOR LEAVES**

handle **CUBE SLIM** (prestigious 6 mm thick escutcheon)

**Metal-Bud**

PRODUCENT KLAMEK

shiny chrome, brushed matt chrome, shiny brass, satin brass, matt black



**CUBE SLIM**  
shiny chrome

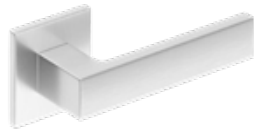

**CUBE SLIM**  
brushed matt chrome

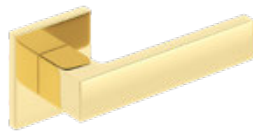

**CUBE SLIM**  
shiny brass



**CUBE SLIM**  
satin brass

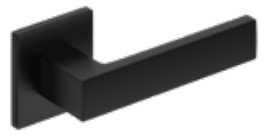

**CUBE SLIM**  
black matt

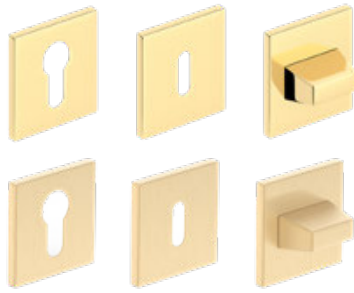

HANDLE CLASS  
**PREMIUM**

handle **CUBE**

**Metal-Bud**

PRODUCENT KLAMEK

shiny chrome, brushed matt chrome, brushed matt nickel, matt black

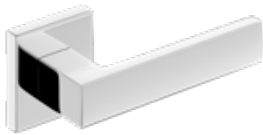

**CUBE**  
shiny chrome



**CUBE**  
brushed matt chrome



**CUBE**  
brushed matt nickel



**CUBE**  
black matt

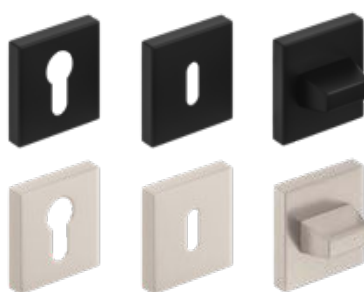
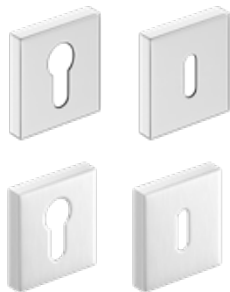

HANDLE CLASS  
**PREMIUM**

handle **CUBE PREMIUM**

**Metal-Bud**

PRODUCENT KLAMEK

shiny chrome, brushed matt chrome, brushed matt nickel, matt black



**CUBE PREMIUM**  
shiny chrome



**CUBE PREMIUM**  
brushed matt chrome



**CUBE PREMIUM**  
brushed matt nickel



**CUBE PREMIUM**  
black matt

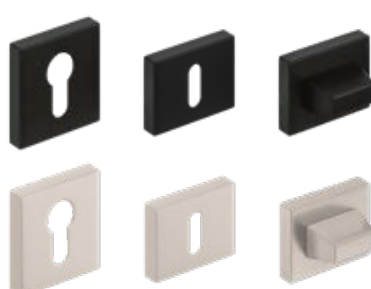
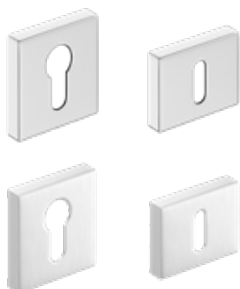

HANDLE CLASS  
**PREMIUM**



## HANDLES FOR PANEL AND STILE DOOR LEAVES

NEW

handles **OLIWIA R**, **LAURA R** classic escutcheon

shiny chrome, matt black, shiny brass

**Metal-Bud**

PRODUCENT KLAMEK



**OLIWIA R**  
shiny chrome



**OLIWIA R**  
black matt



**OLIWIA R**  
shiny brass



**LAURA R**  
shiny chrome



**LAURA R**  
black matt



**LAURA R**  
shiny brass



NEW

handle **JULIA R**

shiny chrome, matt black, shiny brass

**Metal-Bud**

PRODUCENT KLAMEK



**JULIA R**  
shiny chrome



**JULIA R**  
black matt



**JULIA R**  
shiny brass



NEW

handles **NOVA** and **JOWISZ**

matt brass PVD, black matt

**Metal-Bud**

PRODUCENT KLAMEK



**NOVA**  
matt brass PVD

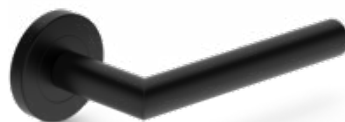

**NOVA**  
black matt



**JOWISZ**  
black matt

NEW



HANDLES FOR PANEL AND STILE DOOR LEAVES

NEW

handle RUMBA K FIT

Metal-Bud

PRODUCENT KLAMEK

matt brass



**RUMBA K FIT**  
matt brass

NEW

handle LUNA SLIM PREMIUM SQUARE

Metal-Bud

PRODUCENT KLAMEK

shiny chrome, brushed matt chrome, shiny brass, black matt



**LUNA SLIM square**  
shiny chrome

**LUNA SLIM square**  
brushed matt chrome

**LUNA SLIM square**  
shiny brass

**LUNA SLIM square**  
black matt



HANDLE CLASS  
**PREMIUM**

NEW

handles BELLA SLIM ROUND, LUNA SLIM PREMIUM ROUND (prestigious 6 mm thick escutcheon)

Metal-Bud

PRODUCENT KLAMEK

shiny chrome, brushed matt chrome, shiny brass, satin brass, matt black



**BELLA SLIM round**  
shiny chrome

**BELLA SLIM round**  
brushed matt chrome

**BELLA SLIM round**  
shiny brass

**BELLA SLIM round**  
satin brass

**BELLA SLIM round**  
black matt



**LUNA SLIM round**  
shiny chrome

**LUNA SLIM round**  
brushed matt chrome

**LUNA SLIM round**  
shiny brass

**LUNA SLIM round**  
black matt

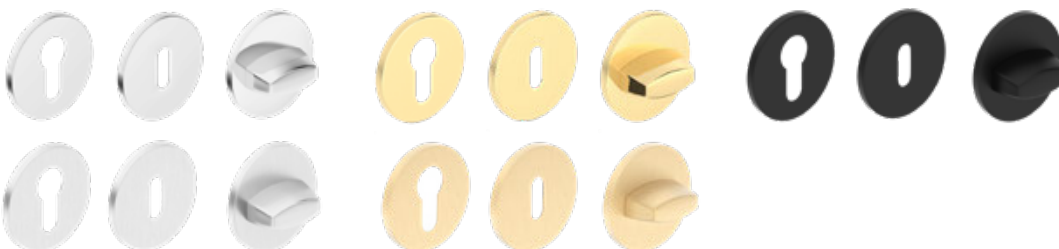

HANDLE CLASS  
**PREMIUM**



# HANDLES FOR PANEL AND STILE DOOR LEAVES

handles **DECO** structural, **IBIZA**, **LINEA**, **TREND**

shiny chrome, satin nickel, graphite/chrome, white matt, black matt

**Metal-Bud**

PRODUCENT KLAMEK



**DECO**  
MEDIUM OAK GREKO decor



**DECO**  
BLACK decor



**DECO**  
WHITE GREKO decor



**DECO**  
SONOMA GREKO decor



**DECO**  
WALNUT GREKO decor



**DECO**  
OAK GREKO decor



**IBIZA**  
shiny chrome



**IBIZA**  
graphite / chrome



**IBIZA**  
satin nickel



**IBIZA**  
matt white



**IBIZA**  
black matt



**LINEA**  
shiny chrome



**LINEA**  
graphite / chrome



**LINEA**  
satin nickel



**TREND**  
satin nickel



**TREND**  
graphite / chrome



**TREND**  
shiny chrome

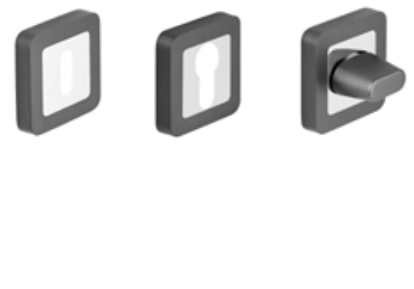
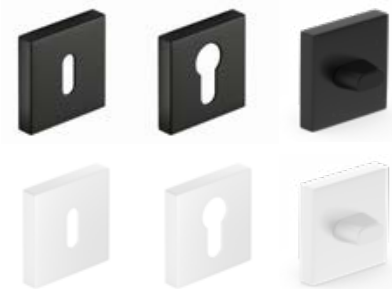

**HANDLES FOR PANEL AND STILE DOOR LEAVES**

**NEW**

handles **QUBIK, BARCELONA, RUMBA K**

velvet nickel, shiny chrome, white matt, black matt, shiny brass, brushed nickel

**Metal-Bud**

PRODUCENT KLAMEK



**QUBIK**  
velvet nickel



**QUBIK**  
shiny chrome

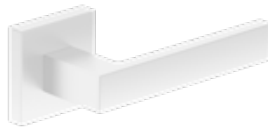

**QUBIK**  
matt white



**QUBIK**  
black matt

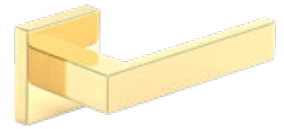

**QUBIK**  
shiny brass



**BARCELONA**  
velvet nickel



**BARCELONA**  
shiny chrome



**BARCELONA**  
black matt



**BARCELONA**  
brushed nickel



**RUMBA K**  
black matt

**NEW**

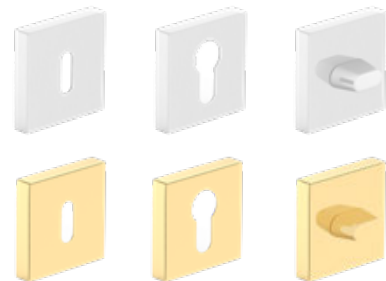
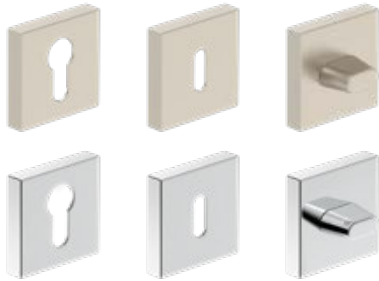

**NEW**

handle **SCALA RT SLIM**

satin nickel, satin brass, black matt

**Metal-Bud**

PRODUCENT KLAMEK



**SCALA RT SLIM**  
satin nickel



**SCALA RT SLIM**  
satin brass



**SCALA RT SLIM**  
black matt



**NEW**

handle **ELEGANZA K FIT**

black matt

**Metal-Bud**

PRODUCENT KLAMEK



**ELEGANZA K FIT**  
black matt, gold insert



**ELEGANZA K FIT**  
black matt, copper insert





## HANDLES FOR PANEL AND STILE DOOR LEAVES

NEW

handle **MONDO**

satin nickel

**Metal-Bud**

PRODUCENT KLAMEK



**MONDO**  
satin nickel



handle **ERKADO**

black matt

**Metal-Bud**

PRODUCENT KLAMEK



**TOPAZ**  
black matt



handles **ERKADO**

inox

**Metal-Bud**

PRODUCENT KLAMEK



**SAPHIRE** inox



**SUPRA** round inox



**PROXIMA** round inox

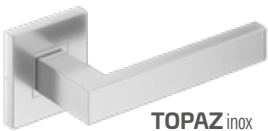

**TOPAZ** inox



**METRO** inox



**PROXIMA** square inox



**NOVA** round inox

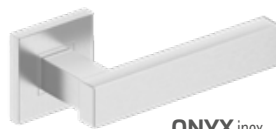

**ONYX** inox



**NOVA** square inox



**JOWISZ** inox



**ROMA** inox



escutcheon for cylinder inox



escutcheon for key inox



WC escutcheon inox



escutcheon for cylinder inox



escutcheon for key inox



WC escutcheon inox

## HANDLES FOR PANEL AND STILE DOOR LEAVES

NEW

handles **CAMILA**

satin chrome, black matt

**Metal-Bud**

PRODUCENT KLAMEK



NEW



NEW



**CAMILA**  
satin chrome

**CAMILA**  
black matt

## HANDLES FOR PANEL AND STILE DOOR LEAVES WITH LONG ESCUTCHEON

Handles with long escutcheon are not used for non-rebated doors (spacing p. 153)

NEW

handles **BLANKA, CAMILA, JULIA, LUNA long escutcheon**

satin chrome, polished brass

**Metal-Bud**

PRODUCENT KLAMEK



**BLANKA** satin chrome



NEW

**CAMILA** satin chrome



**JULIA** polished brass



**LUNA** polished brass

handles **JOWISZ INOX long escutcheon** (escutcheon thickness 10 mm), spacing 72 mm

**HANDLE APPROVED FOR USE IN FIRE DOORS LEDA EI30 AND EI 60 AS WELL AS ENTRANCE DOORS**

investment stainless steel or black

**Metal-Bud**

PRODUCENT KLAMEK



**JOWISZ INOX**  
escutcheon - keyhole profile  
stainless steel  
black



**JOWISZ INOX**  
escutcheon - bathroom  
stainless steel  
black



**JOWISZ INOX**  
escutcheon - cylinder profile  
stainless steel  
black



**JOWISZ INOX**  
escutcheon, economy lock  
stainless steel  
black

handles **TOPAZ INOX long escutcheon** (escutcheon thickness 10 mm), spacing 72 mm

stainless steel

**Metal-Bud**

PRODUCENT KLAMEK



**TOPAZ INOX**  
escutcheon - keyhole profile



**TOPAZ INOX**  
escutcheon - bathroom



**TOPAZ INOX**  
escutcheon - cylinder profile



**TOPAZ INOX**  
escutcheon, economy lock

## HANDLES FOR PANEL AND STILE DOOR LEAVES WITH LONG ESCUTCHEON

Handles with long escutcheon are not used for non-rebated doors (spacing p. 153)

handles **ASTRA**, **SYDNEY** and **QUBIK** long escutcheon, spacing 72 mm

**Metal-Bud**

PRODUCENT KLAMEK

nickel, patina, black matt



**ASTRA**  
nickel, patina  
escutcheon – keyhole  
profile



**SYDNEY**  
nickel, patina  
escutcheon – keyhole  
profile



**ASTRA**  
nickel, patina  
escutcheon, economy lock

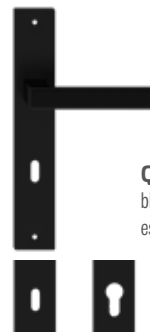

**QUBIK** long escutcheon  
black matt  
escutcheon – keyhole profile



**QUBIK**  
black matt  
escutcheon – cylinder profile, key



**QUBIK**  
black matt  
escutcheon – bathroom

**ASTRA and SYDNEY**  
nickel, patina  
escutcheon – bathroom

**ASTRA**  
nickel, patina  
escutcheon – cylinder profile



**ASTRA**  
nickel, patina  
escutcheon – cylinder profile

**ASTRA**  
nickel, patina  
escutcheon, economy lock

**QUBIK**  
black matt  
escutcheon – cylinder profile, key

**QUBIK**  
black matt  
escutcheon – bathroom

## HANDLES FOR HERSE SET, HERSE LUX SET, HERSE MAX SET DOOR LEAVES

handles **ERKADO BONN** and **ESSEN<sup>1)</sup>** (escutcheon thickness ESSEN – 10 mm, BONN – 8 mm), spacing 72 mm  
handle **ERKADO SMART** spacing 72 mm and 92 mm

**Metal-Bud**

PRODUCENT KLAMEK



inox plus



patina



black matt



**BONN**  
rosette, handle-pull (fixed)



satin nickel



patina



black matt

**ESSEN<sup>1)</sup>**



**NEW**

handle **ERKADO SMART**

**NEW**

handles **CERTUS**, **CERTUS RC2** and **RC3**

spacing 72 mm for HERSE doors or 92 mm for FORTECA doors  
escutcheon thickness: **CERTUS** – 9 mm/9 mm, **RC2** – 12 mm/9 mm, **RC3** – 15 mm/9 mm

**Metal-Bud**

PRODUCENT KLAMEK



upper escutcheon **CERTUS**  
inox, black str



upper escutcheon **CERTUS**  
**RC2**  
inox, black str



upper escutcheon **CERTUS**  
**RC3**  
inox, black str



**CERTUS**  
inox, black str



**CERTUS RC2**  
inox, black str



**CERTUS RC3**  
inox, black str

<sup>1)</sup> ESSEN handles and rosettes cannot be used with a multipoint lock

# TECHNICAL INFORMATION

## DOOR OPENING DIRECTIONS



Do you know how to distinguish right doors from left ones? It's a key decision for the comfort and functionality of your home. Here are some tips:

- Standing in front of the door; position yourself so that the door opens towards you. If the hinges are on the left – it's a left door; if on the right, it's a right door.
- Space planning: avoid collisions with furniture and other doors.
- Functionality: bathroom doors always open outwards.

## REBATED, NON-REBATED, REVERSIBLE DOORS

OPENING DIRECTION



NON-REBATED

REBATED

REVERSIBLE

## CYLINDERS



cylinder satin nickel color



cylinder with knob satin nickel color

Cylinders in one-key system 30/45 + 30G/45  
doors opening outwards – silver, black

Cylinders in one-key system 30/45 + 30/45G  
doors opening inwards – silver, black

CYLINDER size	CYLINDER WITH KNOB size
26/36	G30/40
30/30	G40/30
30/40	G30/50
30/45	G50/30
30/50	30/45G
20/40	30G/45

## NOVA CLICK and TOPAZ CLICK HANDLE

VERSION LEFT

L



VERSION RIGHT

P

The NOVA CLICK and TOPAZ CLICK handle in the LEFT version is used for:  
– right doors opening outwards  
– left doors opening inwards

The NOVA CLICK and TOPAZ CLICK handle in the RIGHT version is used for:  
– right doors opening inwards  
– left doors opening outwards

## DOOR FRAME JOINTS

45°



90°



## HOW TO CALCULATE THE PRICE OF DOORS



## DOUBLE DOORS



## HOW TO CHOOSE A CYLINDER

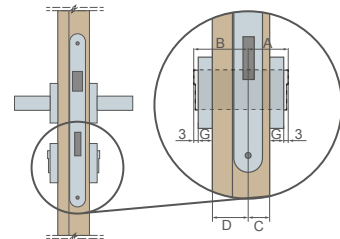

Example calculation of cylinder size for panel and stile doors (40mm) with escutcheon thickness  $G = 7$  mm

$$A/B = (C + G + 3) / (D + G + 3)$$

$$A/B = (15 + 7 + 3) / (25 + 7 + 3)$$

$$A/B = 25/35$$

Type of door	Door leaf thickness	Lock position ratio in the door (C/D)	Recommended cylinder size (A/B) <sup>1)</sup>
panel, stile (rebated)	40 mm	15/25	26/36
panel, stile (non-rebated)	40 mm	20/20	30/30
reversible	40 mm	15/25	26/36
HERSE	46 mm	15/31	30/45
LEDA EI 30	50 mm	19/31	30/40
LEDA EI 60	60 mm	19/41	30/50
FORTECA RC2 and RC3	46 mm	20/26	30/40, 35/40 <sup>2)</sup>
LOFT	39 mm (cassette)	9/30	20/40

<sup>1)</sup> recommended cylinder size for escutcheon thickness 7 mm and clearance from 2 mm to 4 mm  
<sup>2)</sup> for inward opening



## TYPES OF DOOR SURFACE FINISHES

### GREKO

GREKO laminate is also a pre-impregnated foil, meaning it is printed and then protected with a lacquer of desired properties. The use of enhancing finishing layers affects the surface resistance and flexibility of the product. The silicone content in the lacquer makes the foil more resistant.

GREKO laminate is produced on the basis of a high-density Japanese substrate that is non-resinous. As a result, the foil is ecological, safe for health, people, and the environment both during production and use, as well as during disposal. It does not contain: formaldehyde or other harmful substances.

What distinguishes greko foil from others is its unique design. There is a high-quality surface with a natural wood effect (3D effect). The decors closely resemble wood.

### ST CPL, CPL 0.2 and CPL 0.7

CPL laminate consists of a decorative layer impregnated with resins and a bottom layer providing flexibility. After the lamination process, the top (resin) layer is hardened, thus achieving high resistance to scratches and abrasion. It is characterized by high resistance to impacts, abrasion, scratches, as well as high temperatures and UV radiation.

The use of this type of material allows doors to be used in so-called "difficult" rooms [exposed to higher temperatures, humidity, or above-average use]. Laminate thickness approximately: ST CPL - 0.15 mm, CPL 0.2 - 0.2 mm, and CPL 0.7 - 0.7 mm. CPL 0.7 laminate, due to its exceptional hardness, is used only on the door leaf surface. Door leaves covered with CPL 0.2 and CPL 0.7 laminates have the edge of the door leaf made with so-called ABS, a very strong PVC material. ST CPL laminate in white, light gray, cappuccino, black decors has been refined with an AntiFinger coating that limits dirt and fingerprints. **NEW**

### PREMIUM

PREMIUM laminate is a product based on Polypropylene (PP), a material with very high resistance to abrasion and scratches, while also offering high visual qualities. It gives door leaves a noble appearance and individual profile, and faithfully reproduces natural wood. PREMIUM laminate impresses not only with its appearance but also with its functionality, as it is exceptionally scratch-resistant, flame-retardant, and protected against abrasion. The above features mean that PREMIUM line products, thanks to their properties, guarantee long-term trouble-free use even in difficult operating conditions.

### UV-PAINTED

The surface of the door in TITANIUM UV color is painted several times with a modern lacquer using UV curing technology. Flat surfaces are initially protected with a specialized base membrane and then painted twice with world-class paint and cured with UV rays. Milled surfaces, for technological reasons, cannot be protected with a membrane, so they are painted three times and cured with UV rays. Automatic painting (without human involvement) after prior scanning ensures perfect surface quality, while curing the varnish using the most modern ultraviolet (UV) hardening method provides very high mechanical resistance.

## OTTIMO DOOR SURFACE CLEANING, REFRESHING AND REGENERATION KIT



## EDGE FINISH TYPES

### EDGE SOFT

SOFT **NEW**

The SOFT door leaf does not have sharp edges, which gives it an aesthetic and modern appearance. The door leaf is finished with a laminate of increased scratch resistance, which significantly improves its durability in use.









### EDGE STANDARD

STANDARD

It consists of covering the flat surface with ST CPL laminate of 0.15 mm thickness, CPL 0.2, CPL 0.7, polypropylene PREMIUM laminate or GREKO laminate. The door leaf in STANDARD technology has sharp edges, where the top panel is joined with the edge laminate, as shown in the diagram. In CPL 0.2 and CPL 0.7 laminates, this is a very strong PVC laminate, so-called ABS. At the same time, the method of joining the laminate is identical in flush doors for sliding and non-rebated systems.

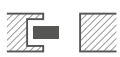

## AVAILABLE SOLUTIONS (pp. 158-169)

- single-leaf door wall-mounted sliding systems 
- double-leaf door wall-mounted sliding systems 
- single-leaf door sliding systems concealed in the wall 
- double-leaf door sliding systems concealed in the wall 
- ZN1 supplementary system 
- Supplementary system ZN2 
- double-leaf doors 

<sup>1)</sup> applies only to BALDUR 1 in WHITE ST CPL decor with solid panel filling

## STILE FRAME DOOR LEAF

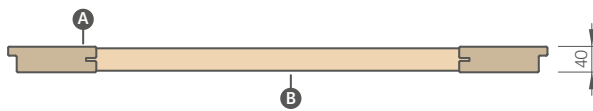
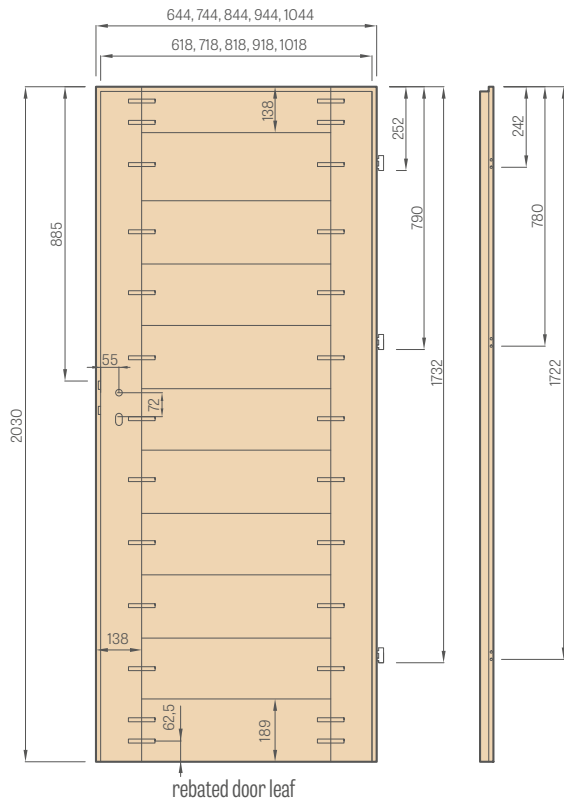

- A** - MDF stiles
- B** - MDF rails



Stable crossbar 35 mm or 22 mm thick



Aesthetic frameless flush glazing



MDF stile for GREKO, PREMIUM and CPL laminates also with AntiFinger coating

**NEW**



Vertical stile made of glulam covered with HDF and MDF boards available at extra charge for decors: WHITE PREMIUM, NATUR OAK PREMIUM, GRAPHITE ASH PREMIUM, GREY MAPLE PREMIUM, OAK ST CPL

## PANEL DOOR LEAF

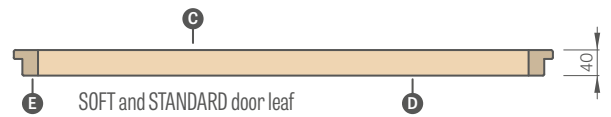
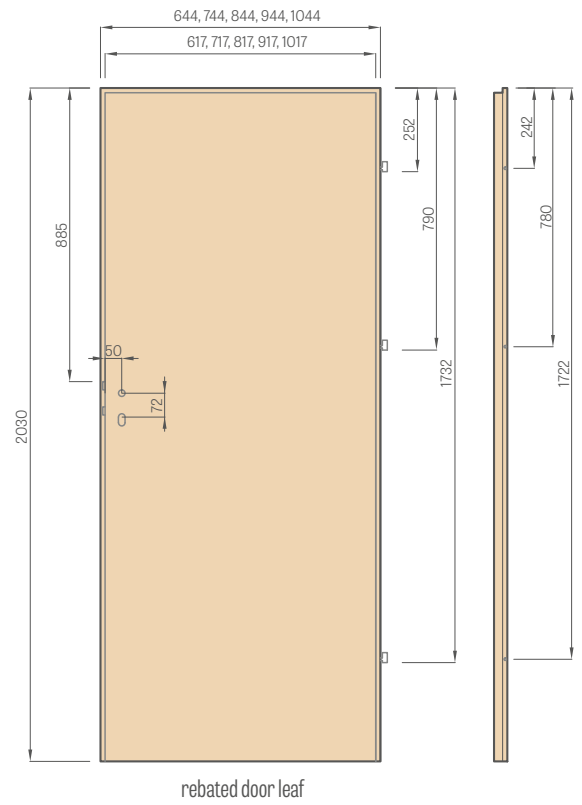

- A** - MDF board
- B** - gasket
- C** - HDF board
- D** - filling
- E** - MDF or wooden stiles in HERSE SET and UNO PREMIUM

## TYPES OF FILLING

honeycomb



solid board filling



Honeycomb and solid panel filling apply ONLY to panel doors. For non-rebrated and reversible panel door leaves with solid panel filling and door leaves in size "100" and "110", we recommend (at extra charge) an additional third hinge.



## GRAF GLASS PANEL

standard hinge

vertical hinge

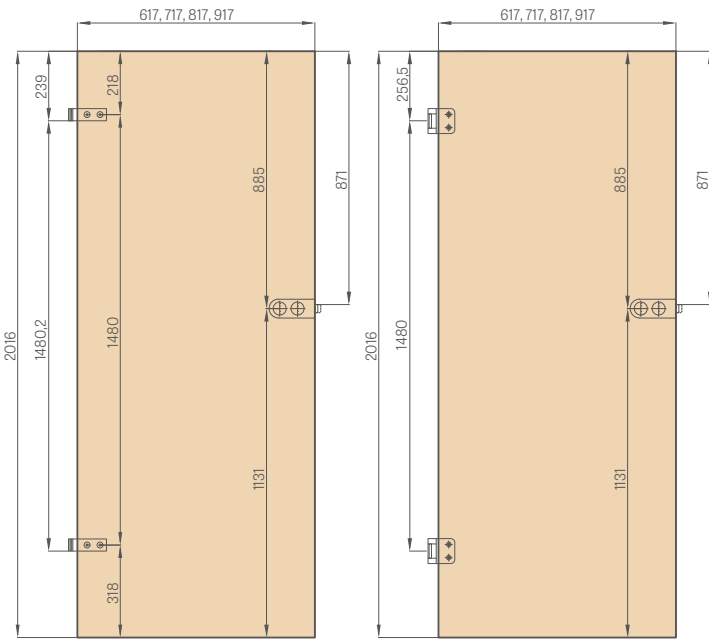

## FIRE DOOR LEAF

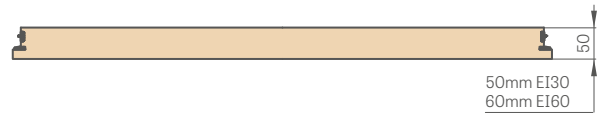
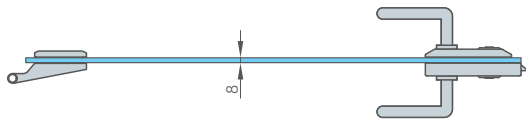
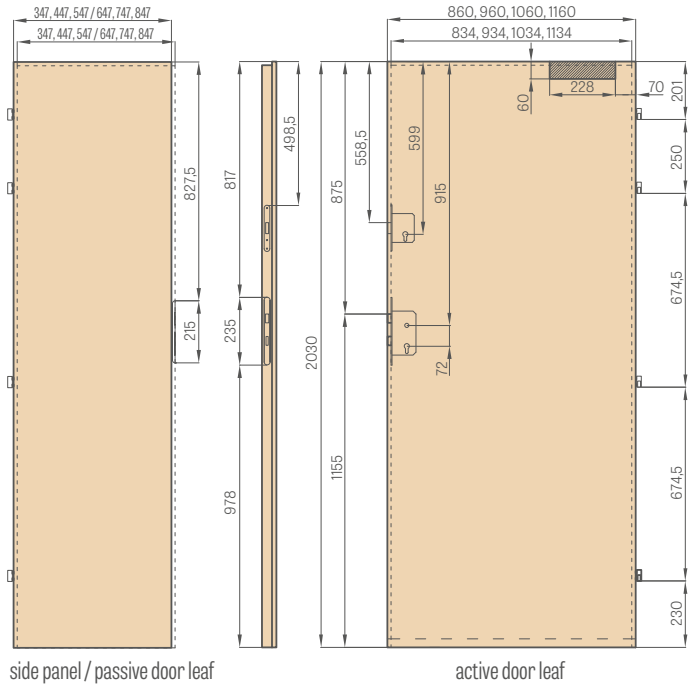

## BATHROOM LOCK ON THE

external (E)

internal (I)

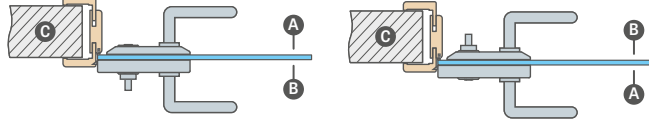

**A** - hallway **B** - bathroom **C** - wall

WC lock - when ordering a lock with a bathroom lock, you must choose:

EXTERNAL lock - when the bathroom lock is to be mounted on the external side of the door (Z)  
or  
INTERNAL lock - when the bathroom lock is to be mounted on the internal side of the door (W).

**NOTE:** Locks with a bathroom lock are handed (right left)



Filling with specialist HALSPAN board: 44 mm [EI30] / 54 mm [EI60]



Fire gasket and swelling smoke seal, in red or black color



Drop-down seal with pressure adjustment using an Allen key



Practical four hinges  $\varnothing 16$  with 3D adjustment

## STANDARD GLAZING "OBVERSE"



## CUSTOM GLAZING "REVERSE"



**G** - plain side **M** - matt side with decoration



Fixed door frame

## FACTORY DRILLING FOR HANDLE



Factory drilling for handle in frame doors for handles with split escutcheon available in Erkado's offer.

## METAL CAPS FOR HINGES

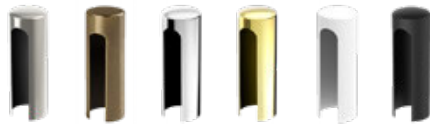

brushed nickel, patina, polished chrome, polished brass, white matt and black matt

Available covers:

- for Herse/Forteca Ø16, length 47 mm in colors: brushed nickel, patina, polished chrome, polished brass, white and black
- for LEDA EI30 Ø16 or LEDA EI60 Ø20, length 64 mm in colors: matt chrome, black (covers cannot be used with doors with a steel frame)
- for internal door leaves Ø15, length 47 mm in colors: brushed nickel, patina, polished chrome, polished brass, white and black

## VENTILATION



Square and round metal sleeves



Wood-like plastic sleeves for STILE frame doors for the GREKO, PREMIUM and CPL decor group

Grilles



## STANDARD RECUPERATION (height 24 mm) or MINI (height 14 mm)

**Enhanced airflow trim** - the entire width of the door leaf is shortened by 15 mm or 5 mm (mini version) from the bottom. The door has a standard clearance between the door leaf and the floor of approximately 9 mm, which together with the enhanced airflow trim gives a clearance of approximately 24 mm or 14 mm (mini version). Enhanced airflow trim is not available in double-leaf doors, in non-rebated door leaves for sliding systems, and in FRAGI and GRAF models.

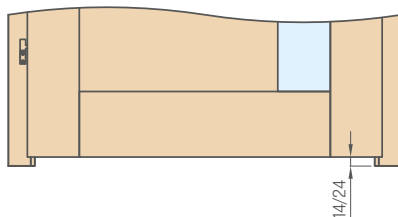

## STANDARD VENTILATION (height 32 mm) or MINI (height 15 mm)

Ventilation undercut is not available in non-rebated door leaves for sliding systems.

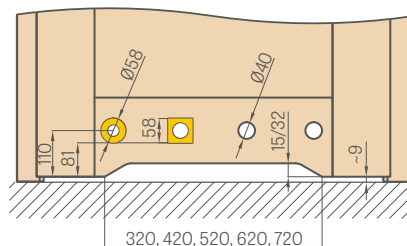

## CLEARANCE UNDER THE INSTALLED LEAF

Please check the given lower clearance dimensions in all products before installation, as the permissible deviation resulting from the frame dimensional tolerance is  $\pm 3$  mm

## ELECTRIC DOOR STRIKE

(available in fixed and adjustable door frames for rebated and non-rebated doors see p. 184-187, but not available for frames for GRAF glass panels and double-leaf doors)



Available types of electric strikes:

- basic 12 V
- basic 24 V
- with switch 12 V
- with switch 24 V
- reversible 12 V
- reversible 24 V

BASIC

WITH SWITCH

REVERSIBLE

- always closed, and opens when voltage is applied
- works like the basic one but can be switched off by sliding the latch
- applying voltage causes closing, no voltage opens

For fire doors, reversible electric strikes and those with a switch are not available

## CUTTING THE DOOR LEAVES

It is possible to shorten door leaves in the PL standard, on your own, up to 50 mm or up to 80 mm in HERSE SET series door leaves (if they have not been factory undercut) and in panel door leaves only with a factory-installed additional bottom beam.

(NOTE: you cannot shorten on your own FRAGI door leaves, double-leaf and fire doors, non-rebated door leaves for sliding systems, GRAF glass doors, FORTECA RC2 and FORTECA RC3 burglar-proof doors, as well as frame door leaves in the CZ standard).

**The height of a door leaf made in the so-called CZ standard is 47 mm lower than the PL standard.**

**Factory shortening of the door lowers the handle by the same value.**

Type of door leaf	Handle height for PL standard (measured from the bottom edge of the door leaf) [mm]
STILE rebated frame door leaves	1107
STILE non-rebated frame door leaves	1110
Rebated panel door leaves	1110
Non-rebated panel door leaves	1110
reversible panel door leaf	1110
GRAF glass door leaves	1131
FORTECA RC2 and RC3 door leaf	1038
HERSE, HERSE AKUSTIC door leaf	1107
HERSE door leaf with strip lock	1033
HERSE United door leaf	1117
LEDA EI30, EI60 door leaf	1115

## HARDWARE - LATCH-BOLT LOCKS

(available in silver color or for an extra charge in black)

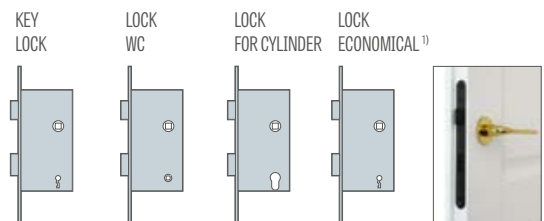

**LOCK SPACINGS:**

1. The spacing of magnetic locks is as follows:

- key, WC: 90mm
  - cylinder: 85mm
- (applies to non-rebated door leaves with magnetic lock and reversible leaves)

2. The spacing of latch-bolt locks is:

- key, WC, cylinder: 72mm
- (applies to rebated leaves and non-rebated door leaves with latch-bolt lock (optional lock))

In WC locks, the hole for the lock is a square with a side of:

- PL standard: 4 mm
- CZ standard: 6 mm

<sup>1)</sup> key lock used without keyhole drilling in the door leaf



## GLAZING IN REVERSIBLE AND NON-REBATED DOORS

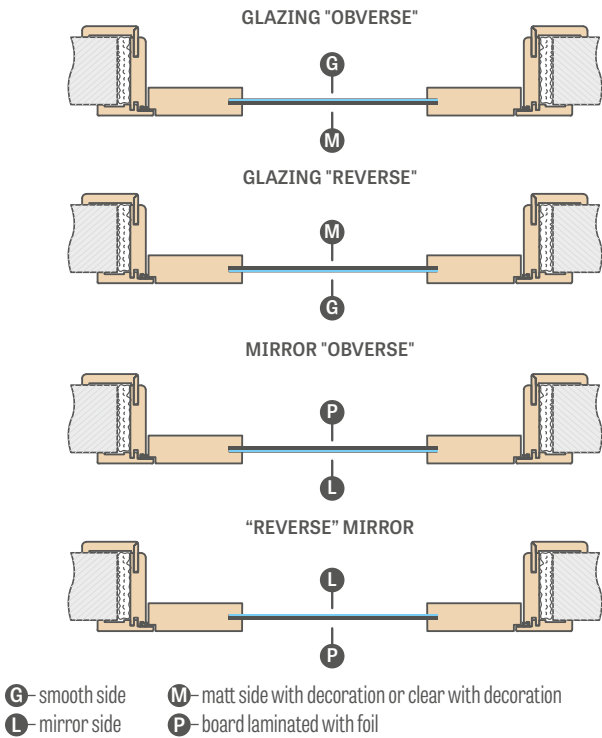

## STANDARD GLAZING WITH VISIBLE HINGE

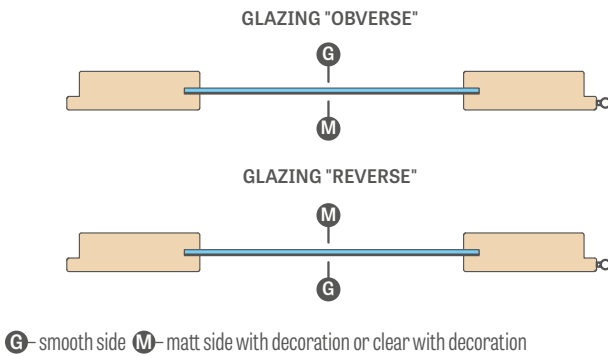

## DOWELING THE FRAME FOR NON-REBATED DOOR LEAVES

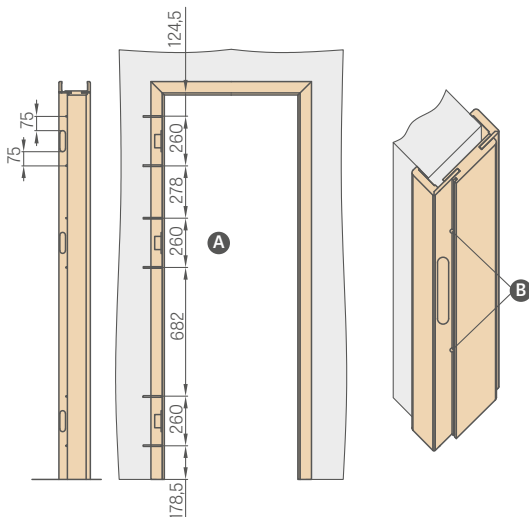

**A** Make holes for metal screws with a minimum length of 80 mm x Ø6 mm  
**B** During the installation of the frame, in addition to mounting foam on the hinge side, the use of mounting anchors is required. Drill holes for screws under the gasket so that the installation of the gasket covers them.

## ILLUSTRATION OF GLAZING TRANSPARENCY

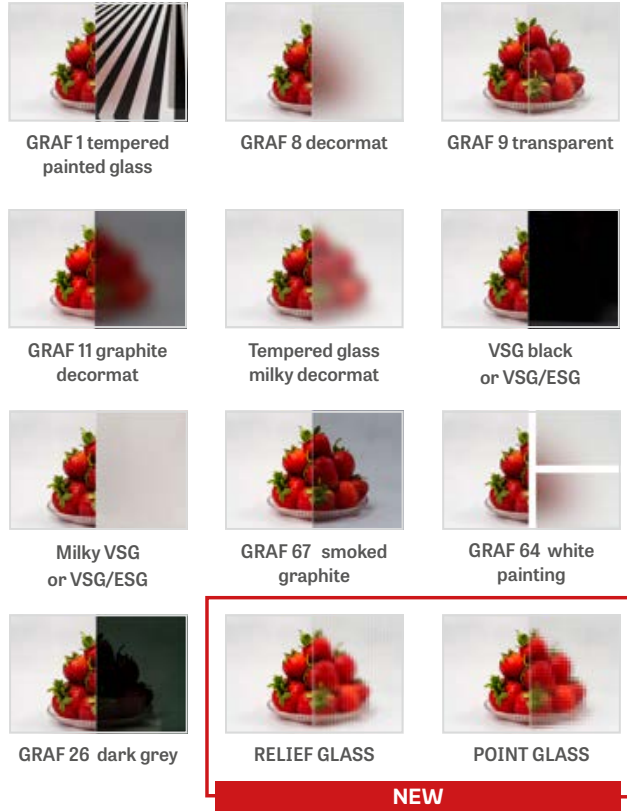

## LAMINATED GLASS VSG 221, 331, 441 MILKY and BLACK for STILE frame and panel doors

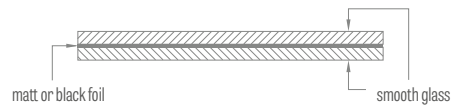

## NON-REBATED and REVERSIBLE HARDWARE



# CROSSHEADS AND PILASTERS

PEONIA 1 in GREY/ST CPL decor, with CUBE PREMIUM handle, with decorative crosshead and pilasters

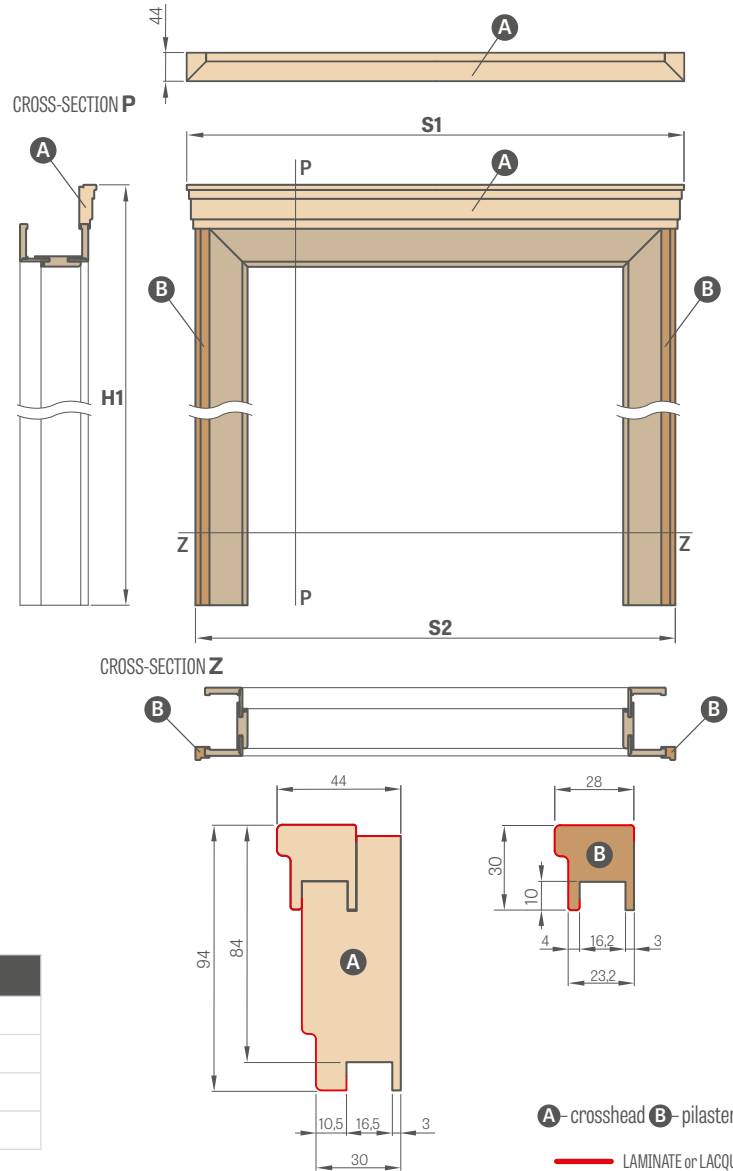

**A** - crosshead **B** - pilaster  
— LAMINATE or LACQUER

SET PRICE <sup>1)</sup> (CROSSHEAD + PILASTERS)
GREKO
ST CPL and PREMIUM
CPL 0.2 and CPL 0.7
LACQUERED

<sup>1)</sup> price applies to a set for one side; standard PL2112 - 15% surcharge  
 Set for double-leaf doors - 30% surcharge

Door width	FRAME and TUNNEL ADJUSTABLE REBATED		FRAME and TUNNEL ADJUSTABLE NON-REBATED		ADJUSTABLE REVERSE DOOR FRAME	
	S1	S2	S1	S2	S1	S2
"60"	838 <sup>2)</sup> /878 <sup>3)</sup>	788 <sup>2)</sup> /828 <sup>3)</sup>	863 <sup>2)</sup> /903 <sup>3)</sup>	813 <sup>2)</sup> /853 <sup>3)</sup>	883 <sup>4)</sup> /926 <sup>5)</sup>	833 <sup>4)</sup> /876 <sup>5)</sup>
"70"	938 <sup>2)</sup> /978 <sup>3)</sup>	888 <sup>2)</sup> /928 <sup>3)</sup>	963 <sup>2)</sup> /1003 <sup>3)</sup>	913 <sup>2)</sup> /953 <sup>3)</sup>	983 <sup>4)</sup> /1026 <sup>5)</sup>	933 <sup>4)</sup> /976 <sup>5)</sup>
"80N"	-	-	1039 <sup>2)</sup> /1079 <sup>3)</sup>	989 <sup>2)</sup> /1029 <sup>3)</sup>	1058 <sup>4)</sup> /1100 <sup>5)</sup>	1008 <sup>4)</sup> /1050 <sup>5)</sup>
"80"	1038 <sup>2)</sup> /1078 <sup>3)</sup>	988 <sup>2)</sup> /1028 <sup>3)</sup>	1063 <sup>2)</sup> /1103 <sup>3)</sup>	1013 <sup>2)</sup> /1053 <sup>3)</sup>	1083 <sup>4)</sup> /1126 <sup>5)</sup>	1033 <sup>4)</sup> /1076 <sup>5)</sup>
"90"	1138 <sup>2)</sup> /1178 <sup>3)</sup>	1088 <sup>2)</sup> /1128 <sup>3)</sup>	1163 <sup>2)</sup> /1203 <sup>3)</sup>	1113 <sup>2)</sup> /1153 <sup>3)</sup>	1183 <sup>4)</sup> /1226 <sup>5)</sup>	1133 <sup>4)</sup> /1176 <sup>5)</sup>
"100"	1238 <sup>2)</sup> /1278 <sup>3)</sup>	1188 <sup>2)</sup> /1228 <sup>3)</sup>	1263 <sup>2)</sup> /1303 <sup>3)</sup>	1213 <sup>2)</sup> /1253 <sup>3)</sup>	1283 <sup>4)</sup> /1326 <sup>5)</sup>	1233 <sup>4)</sup> /1276 <sup>5)</sup>
"110"	1338 <sup>2)</sup> /1378 <sup>3)</sup>	1288 <sup>2)</sup> /1328 <sup>3)</sup>	1363 <sup>2)</sup> /1403 <sup>3)</sup>	1313 <sup>2)</sup> /1353 <sup>3)</sup>	1383 <sup>4)</sup> /1426 <sup>5)</sup>	1333 <sup>4)</sup> /1376 <sup>5)</sup>

<sup>2)</sup> angle bracket with architrave 6 cm, <sup>3)</sup> angle bracket with architrave 8 cm, <sup>4)</sup> reversible trim, <sup>5)</sup> adjustable RW angle bracket

	H1					
	FRAME and TUNNEL ADJUSTABLE REBATED		FRAME and TUNNEL ADJUSTABLE NON-REBATED		ADJUSTABLE REVERSE DOOR FRAME	
	clip-on square with architrave 6 cm	clip-on square with architrave 8 cm	clip-on square with architrave 6 cm	clip-on square with architrave 8 cm	reversible trim	adjustable clip-on square
NORMA PL	2174	2194	2187	2207	2207	2229
NORMA PL 2112	2256	2276	2269	2289	-	-

**NOTE:** Selecting a set (crosshead + pilasters) for an adjustable rebated, non-rebated, or reversible frame reduces the working range of the frame by 3 mm (for single-sided use) or 6 mm (for double-sided use). Example: for a wall thickness of 140 mm with a single-sided set, you should assume it is 143 mm, and with a double-sided set, that it is 146 mm, and select the corresponding wall coverage range from the table for the rebated frame (p. 186), non-rebated (p. 184), or reversible (p. 183).

# DOOR FRAME EXTENSION PANELS

## WALL-MOUNTED

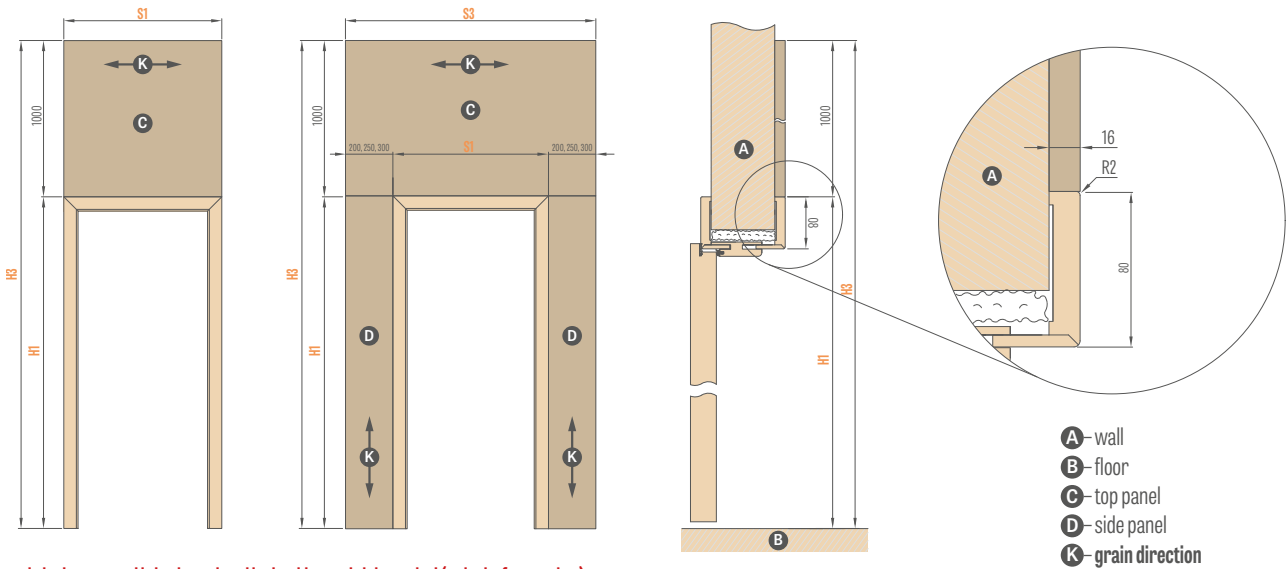

The grain in the top panel is horizontal, and in the side panels it is vertical (as in the frame trims).  
Panels available only for 8 cm wide trim.

INTERIOR DOORS <sup>1) 2)</sup>				
Type of frame	H1	H3	Width	S1
Adjustable door frame rebated	2109	3109	"60"	786
			"70"	886
			"80"	986
			"90"	1086
			"100"	1186
Adjustable door frame non-rebated	2122	3122	"60"	811
			"70"	911
			"80N"	987
			"80"	1011
			"90"	1111
Reverse door frame (side flush with the door leaf)	2122	3122	"60"	791
			"70"	891
			"80N"	966
			"80"	991
			"90"	1091
Reverse door frame	2144	3144	"60"	834
			"70"	934
			"80N"	1010
			"80"	1034
			"90"	1134
			"100"	1234
			"110"	1334

TOP PANEL (1000 x S1) <sup>1)</sup>

ENTRANCE DOORS <sup>3)</sup> (panels on the stairwell side, doors opening inward)										
Type of frame	H1	H3	Width	S1	S3					
Adjustable door frame HERSE	2109	3109	"80"	986	1186	1236	1286	1386	1486	1586
			"90E"	1090	1290	1340	1390	1490	1590	1690
			"100"	1186	1386	1436	1486	1586	1686	1786
			"80N"	1012	1212	1262	1312	1412	1512	1612
Fixed door frame HERSE "clip"	2142	3142	"80"	1052	1252	1302	1352	1452	1552	1652
			"90E"	1156	1356	1406	1456	1556	1656	1756
			"100"	1252	1452	1502	1552	1652	1762	1852
Fixed door frame FORTECA "clip"	2147	3147	"80N"	1012	1212	1262	1312	1412	1512	1612
			"80"	1056	1256	1306	1356	1456	1556	1656
			"90E"	1156	1356	1406	1456	1556	1656	1756
			"100"	1256	1456	1506	1556	1656	1756	1856
Fixed door frame with adjustment FORTECA (from the installation side)	2136	3136	"80N"	990	1190	1240	1290	1390	1490	1590
			"80"	1034	1234	1284	1334	1434	1534	1634
			"90E"	1134	1334	1384	1434	1534	1634	1734
Fixed door frame LEDA "clip"	2147	3147	"80"	1085	1285	1335	1385	1485	1585	1685
			"90E"	1185	1385	1435	1485	1585	1685	1785
			"100"	1285	1485	1535	1585	1685	1785	1885
Fixed door frame with adjustment LEDA (from the installation side)	2136	3136	"80"	1063	1263	1313	1363	1463	1563	1663
			"90E"	1163	1363	1413	1463	1563	1663	1763
			"100"	1263	1463	1513	1563	1663	1763	1863

PANEL 200	PANEL 250	PANEL 300	2 x PANEL 200	2 x PANEL 250	2 x PANEL 300
SINGLE-SIDED SIDE PANEL			DOUBLE-SIDED SIDE PANEL		

DOOR FRAME EXTENSION PANELS <sup>2)</sup> – price per m <sup>2</sup>
GREKO
CPL0.2, ST CPL and PREMIUM
UV LACQUER

<sup>1)</sup> for interior door frames, only top panels are available

<sup>2)</sup> the panels on all four edges are finished with edging in a color similar to the panel surface. The surface area is calculated from the tables above.

<sup>3)</sup> panels are available only for frame solutions with architrave 8 cm

# INTEGRATED SINGLE-SIDED EXTENSION PANELS

INSTALLED INSTEAD OF A MOVABLE ANGLE BRACKET OR WITH A CLIP

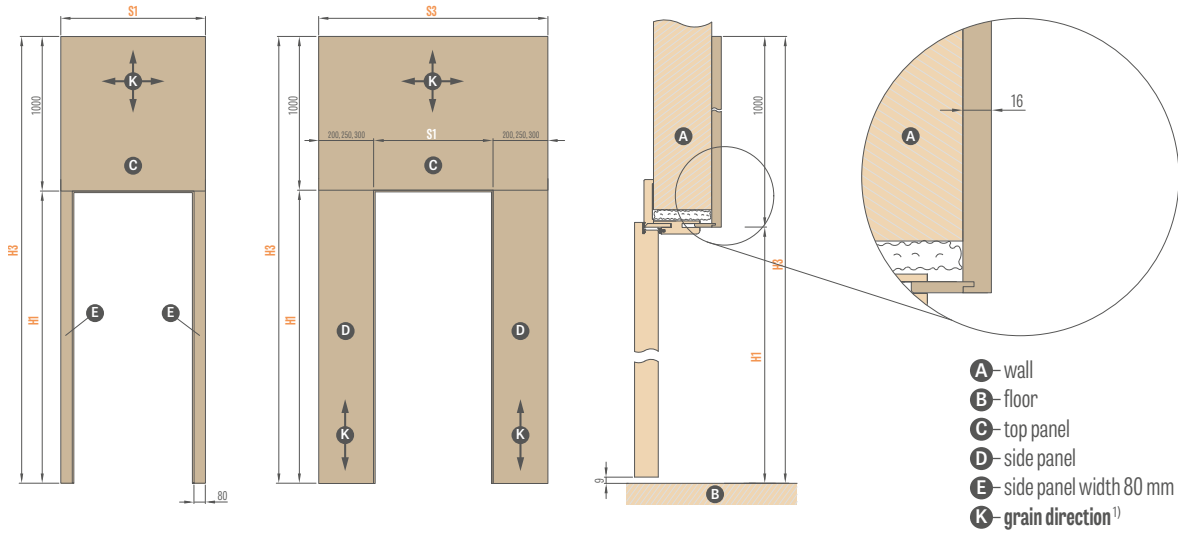

INTERIOR DOORS <sup>2)</sup>				
Type of frame	H1	H3	Width	S1
Adjustable door frame rebated (from the adjustable angle bar side)	2029	3029	"60"	786
			"70"	886
			"80"	986
			"90"	1086
			"100"	1186
			"110"	1286
Adjustable door frame non-rebated (from the adjustable angle bar side)	2042	3042	"60"	811
			"70"	911
			"80N"	987
			"80"	1011
			"90"	1111
			"100"	1211
Reverse door frame (from the adjustable angle bar side)	2064	3064	"60"	834
			"70"	934
			"80N"	1010
			"80"	1034
			"90"	1134
			"100"	1234
<b>TOP PANEL (1000 x S1) <sup>1)</sup></b>				

ENTRANCE DOORS (panels on the staircase side, doors opening inwards)										
Type of frame	H1	H3	Width	S1	S3					
Adjustable door frame HERSE (from the adjustable angle bar side)	2029	3029	"80"	986	1106	1156	1206	1226	1326	1426
			"90E"	1090	1210	1260	1310	1330	1430	1530
			"100"	1186	1306	1356	1406	1426	1526	1626
Fixed door frame HERSE "clip"	2062	3062	"80N"	1012	1132	1182	1232	1252	1352	1452
			"80"	1052	1172	1222	1272	1292	1392	1492
			"90E"	1156	1276	1326	1376	1396	1496	1596
Fixed door frame FORTECA "clip"	2068	3068	"80N"	1012	1132	1182	1232	1252	1352	1452
			"80"	1056	1176	1226	1276	1296	1396	1496
			"90E"	1156	1276	1326	1376	1396	1496	1596
Fixed door frame with adjustment FORTECA (from the installation side)	2057	3057	"80N"	990	1110	1160	1210	1230	1330	1430
			"80"	1034	1154	1204	1254	1274	1374	1474
			"90E"	1134	1254	1304	1354	1374	1474	1574
Fixed door frame LEDA "clip"	2068	3068	"80"	1085	1205	1255	1305	1325	1425	1525
			"90E"	1185	1305	1355	1405	1425	1525	1625
			"100"	1285	1405	1455	1505	1525	1625	1725
			"110" <sup>4)</sup>	1385 <sup>4)</sup>	1505 <sup>4)</sup>	1555 <sup>4)</sup>	1605 <sup>4)</sup>	1625 <sup>4)</sup>	1725 <sup>4)</sup>	1825 <sup>4)</sup>
Fixed door frame with adjustment LEDA (from the installation side)	2057	3057	"80"	1063	1183	1233	1283	1303	1403	1503
			"90E"	1163	1283	1333	1383	1403	1503	1603
			"100"	1263	1383	1433	1483	1503	1603	1703
			"110" <sup>4)</sup>	1363 <sup>4)</sup>	1483 <sup>4)</sup>	1533 <sup>4)</sup>	1583 <sup>4)</sup>	1603 <sup>4)</sup>	1703 <sup>4)</sup>	1803 <sup>4)</sup>

DOOR FRAME EXTENSION PANELS <sup>3)</sup> – price per m <sup>2</sup>
<b>GREKO</b>
<b>CPL0.2, ST CPL and PREMIUM</b>
<b>UV LACQUER</b>

<sup>1)</sup> The grain direction in the top panel up to a panel width of S1 ≤ 1050 mm can be horizontal or vertical, and above S1 > 1050 mm only horizontal

<sup>2)</sup> for internal door frames, only top panels are available

<sup>3)</sup> the panels on all four edges are finished with edging in a color similar to the panel surface. The surface area is calculated from the tables above.

<sup>4)</sup> applies only to LEDA doors



# SLIDING SYSTEMS

## WALL-MOUNTED

### WALL-MOUNTED SLIDING DOOR SYSTEM:

<b>SINGLE SP1Nz (with latch)</b>	
<b>SINGLE SP1Nb (without latch)</b>	
<b>DOUBLE SP2N</b>	

The price includes:

Aluminum rail with cover and bumper in the color of the door leaf, with a length of:

- 230 cm for door leaf "110"<sup>4)</sup>
- 210 cm for door leaf "100"
- 200 cm for door leaf "90"
- 180 cm for door leaf "80"
- 150 cm for door leaf "70", "60"

### Available configurations of wall-mounted sliding systems:

- rail with cover and bumper with gasket (only SP1Nz and SP1Nb)
- rail with cover and tunnel frame (only SP2N)
- rail with cover and bumper + tunnel frame (only SP1Nz and SP1Nb)
- rail with cover and bumper with gasket + tunnel frame (only SP1Nz and SP1Nb)

The wall-mounted sliding system SP1N and SP2N with selected door leaves is also available in standard PL2112.

It is not possible to make an undercut in a non-rebated door leaf for the wall-mounted sliding system.

The cover from the inside is neither laminated nor lacquered.

### EXTRA CHARGES

#### adjustable door frame type "tunnel"

included in the price of the adjustable door frame

#### hook bolt lock with hardware<sup>2)</sup>

option only for single system

#### oval, rectangular or round pull handle

in colors: shiny chrome, brushed chrome, shiny brass, matt black; a set of handles consists of two pieces

#### synchronization

simultaneous opening or closing of two door leaves is possible only by using one door leaf applies only to SP2N

#### crosshead and pilasters

#### damper<sup>3)</sup>

automatic damping of the door leaf in the final phase of closing

applies only to SP1Nz and SP1Nb

#### standard 2112

surcharge for door leaf available in standard 2112 and tunnel

+ 15%

### ROUND, OVAL, RECTANGULAR HANDLES<sup>1)</sup>

shiny chrome, brushed chrome, shiny brass, matt black



### HOOK LOCKS WITH KEY

shiny chrome, brushed chrome, shiny brass, black matt



The key is only available in silver color

The hook lock with key includes two selected handles

<sup>1)</sup> in the BALDUR 8 model, the oval and square pull handle overlaps the milling

<sup>2)</sup> NOTE: the height of the oval handle for the key / WC variant is different and amounts to: key: 1006 mm, WC option: 1015 mm (dimension measured from the bottom edge of the door leaf)

<sup>3)</sup> use only on one side

<sup>4)</sup> only for door models available in width "110"

# WALL-MOUNTED SLIDING DOOR SYSTEM

WITH FRAME CASING

SP1Nz or SP1Nb (left, obverse version)

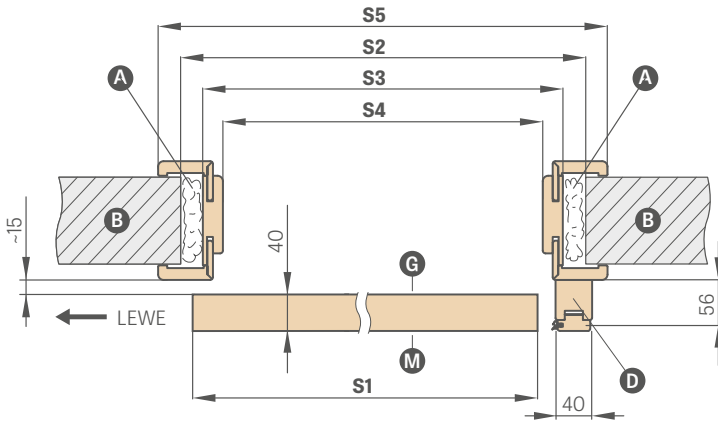

SP2N (obverse version)

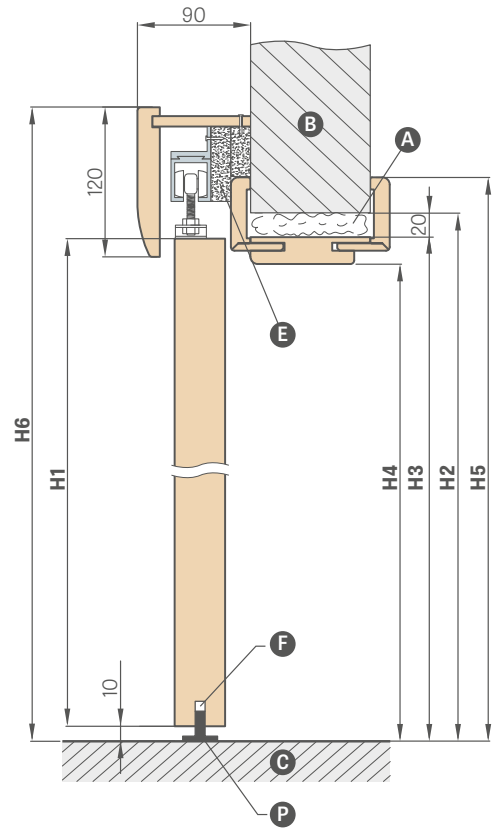
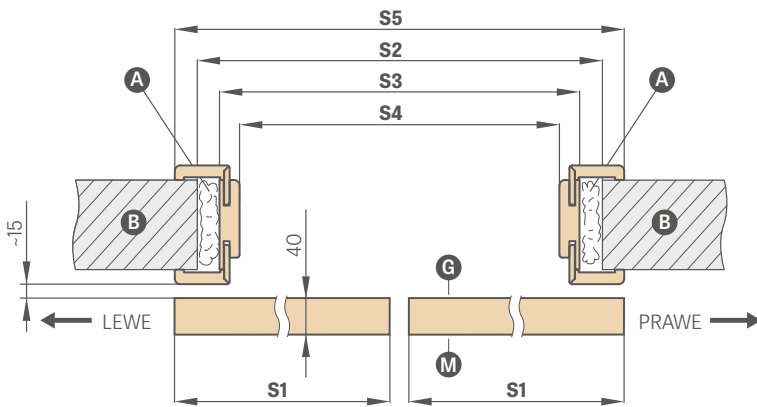

- A - foam
- B - wall
- C - floor
- D - bumper beam (directional in standard PL2112)
- E - spacer strips
- F - molding for a guide
- G - smooth side of the glass
- P - floor guide
- M - matt side of the glass

WALL-MOUNTED SLIDING DOOR SYSTEM WITH FRAME CASING

		SINGLE-LEAF DOOR					DOUBLE-LEAF DOORS				
		"60"	"70"	"80"	"90"	"100"	"60" x 2	"70" x 2	"80" x 2	"90" x 2	"100" x 2
S1	Door leaf width	644	744	844	944	1044	1288	1488	1688	1888	2088
S2	Width of the opening in the wall	688	788	888	988	1088	1288	1488	1688	1888	2088
S3	External width of the frame	648	748	848	948	1048	1248	1448	1648	1848	2048
S4	Clear width of the frame	604	704	804	904	1004	1204	1404	1604	1804	2004
S4	Width of the opening in the wall for SPN WITHOUT CASING	604	704	804	904	1004	1204	1404	1604	1804	2004
S5	Door frame coverage width architrave 6 cm / architrave 8 cm	746 / 786	846 / 886	946 / 986	1046 / 1086	1146 / 1186	1346 / 1386	1546 / 1586	1746 / 1786	1946 / 1986	2146 / none
H1	Door leaf height	2030 (2112) <sup>1)</sup>									
H2	Height of the opening in the wall	2060 (2142) <sup>1)</sup>									
H2	Height of the opening in the wall for SPN without casing	2020 (2102) <sup>1)</sup>									
H3	External height of the frame	2040 (2122) <sup>1)</sup>									
H4	Clear height of the frame	2018 (2100) <sup>1)</sup>									
H5	Frame covering height architrave 6 cm / architrave 8 cm	2089 / 2109 (2171 / 2191) <sup>1)</sup>									2089 / none (2171 / 2191) <sup>1)</sup>
H6	Total height of the system	2142 (2224) <sup>1)</sup>									

<sup>1)</sup> standard PL2112

# WALL-MOUNTED SLIDING DOOR SYSTEM

## LOFT STANDARD type



BALDUR 7 door leaf in WHITE TITANIUM UV decor, with a black rectangular handle, with INDUSTRIAL door leaf grip

The single LOFT STANDARD sliding system is available with all door leaves present in the standard SP1N wall-mounted sliding system.

The double LOFT STANDARD sliding system consists of two single systems and a rail connector.

The double LOFT STANDARD system is counted as 2 x single system + rail connector. Three door leaves grips to choose from: INDUSTRIAL, RETRO, and ART (p. 161).

### LOFT STANDARD sliding system

oval, rectangular or round handle<sup>3)</sup>

soft-close on one side<sup>5)</sup>

door leaf "100"

rail connector (enables the use of the LOFT system in a double-leaf door system)

standard 2112 – surcharge for a door leaf available in standard 2112 + 15%

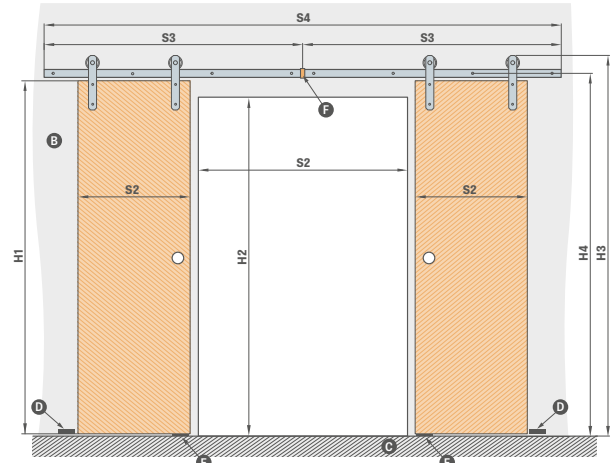
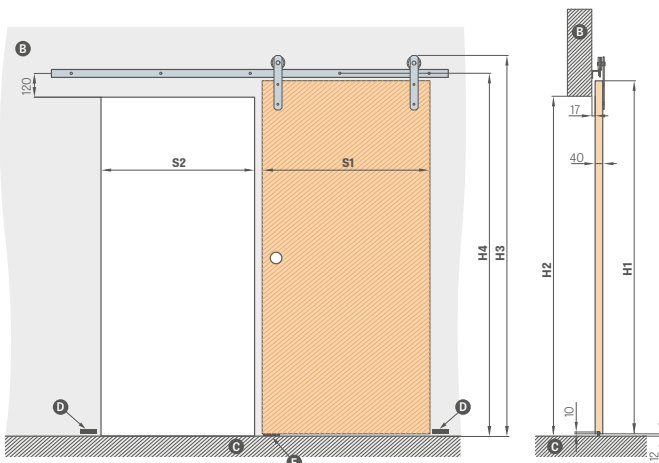

	"60"	"70"	"80"	"90"	"100"	
S1	door leaf width	644	744	844	944	1044
S2	width of the wall opening <sup>1)</sup>	574	674	774	874	974
H1	door leaf height	2030 (2112) <sup>4)</sup>				
H2	height of the wall opening	1962 (2044) <sup>4)</sup>				
H3	total system height	2170 (2252) <sup>4)</sup>				
H4	height to mounting holes in the running rail	2082 (2164) <sup>4)</sup>				

	"120"	"140"	"160"	"180"	"200"	
S1	door leaf width	2 x 644	2 x 744	2 x 844	2 x 944	2 x 1044
S2	width of the wall opening <sup>1)</sup>	1202	1402	1602	1802	2002
S3	rail width	2000	2000	2000	2500	2500
S4	total rail width <sup>2)</sup>	4000	4000	4000	5000	5000
H1	door leaf height	2030 (2112) <sup>4)</sup>				
H2	height of the wall opening	1962 (2044) <sup>4)</sup>				
H3	total system height	2170 (2252) <sup>4)</sup>				
H4	height to mounting holes in the running rail	2082 (2164) <sup>4)</sup>				

### RAIL FOR SINGLE SYSTEM WITH LENGTH:

– 200 cm for door leaf "60" "70" "80"

– 250 cm for door leaf "90" "100"

**B** – wall **C** – floor **D** – bumper mounted to the wall  
**E** – guide **F** – rail connector<sup>2)</sup>

<sup>1)</sup> in the closed position, the door leaf overlaps by 35 mm on each side

<sup>2)</sup> in the double-leaf door system, the rail consists of two rails connected by a connector

<sup>3)</sup> in the BALDUR 8 model, the oval and square handle overlaps the milling

<sup>4)</sup> standard PL2112

<sup>5)</sup> used on one side for the single system, on both sides for the double system

# WALL-MOUNTED SLIDING DOOR SYSTEM

## LOFT type



LOFT door leaf in OAK ST CPL decor, with a round handle, with RETRO door leaf grip

The LOFT type wall-mounted sliding system is available in black and as a set with a solid LOFT type door leaf. The LOFT type door leaf comes standard with a "honeycomb" stabilizing core or, for an extra charge, with a solid board. The door leaf has an edgeless technology edge. The system is intended for a finished opening; no tunnel is available. The complete system consists of: LOFT sliding system + LOFT door leaf + handle + soft-close, single-sided or double-sided. The double LOFT system is counted as 2 x single system + rail connector. Three door leaf grips to choose from: INDUSTRIAL, RETRO, and ART.

### LOFT type sliding system

- oval, rectangular or round pull handle
- solid core filling
- door leaf "100"
- round and square metal sleeves (4 pcs.) finish: black matt
- soft-close on one side<sup>3)</sup>
- rail connector (enables the use of the LOFT system in a double-leaf door system)
- black door leaf edge finish

PREMIUM / CPL	CPL 0.2	UV LACQUER
---------------	---------	------------

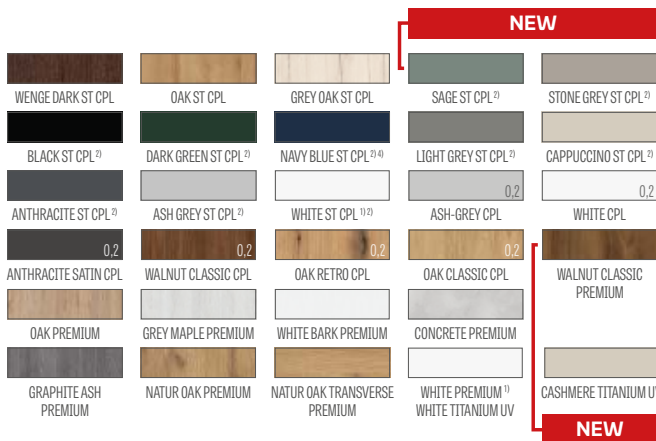

<sup>1)</sup> smooth white laminate imitating a painted surface  
<sup>2)</sup> special **AntiFinger** coating **NEW** limiting dirt and fingerprints  
<sup>3)</sup> used unilaterally for a single system, bilaterally for a double system  
<sup>4)</sup> while stocks last

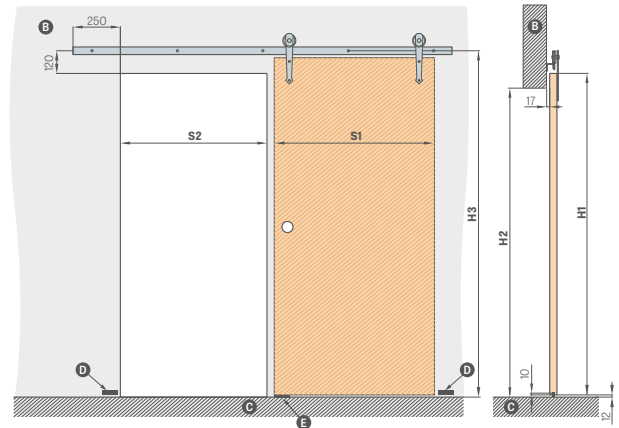

	"60"	"70"	"80"	"90"	"100"
S1 door leaf width	644	744	844	944	1044
S2 width of the wall opening	574	674	774	874	974
H1 door leaf height	2150	2150	2150	2150	2150
H2 height of the wall opening	2082	2082	2082	2082	2082
H3 height to mounting holes in the running rail	2202	2202	2202	2202	2202

B- wall C- floor D- bumper mounted to the wall E- guide

### ROUND, OVAL, RECTANGULAR METAL HANDLES

shiny chrome, brushed chrome, shiny brass, matt black



### RAIL WITH LENGTH:

- 200 cm for door leaf "60" "70" "80"  
 - 250 cm for door leaf "90" "100"

### DOOR LEAF GRIPS



# WALL-MOUNTED SLIDING DOOR SYSTEM

## MAGIC type



MAGIC door leaf in OAK PREMIUM decor, with oval handle

The MAGIC type wall-mounted sliding system is only available as a set with a solid MAGIC type door leaf. The MAGIC type door leaf comes standard with a stabilizing "honeycomb" core or, for an extra charge, with a solid board. The door leaf features an edgeless technology edge. The system is intended for a fully finished opening; a tunnel is not available. The complete system consists of: MAGIC sliding system + MAGIC door leaf + pull handle. The system is only available as a set (system + door leaf).

### MAGIC sliding system

oval, rectangular or round pull handle

solid core filling

door leaf "100"

round and square metal sleeves (4 pcs.); finish: shiny chrome, brushed chrome, black matt

black door leaf edge finish

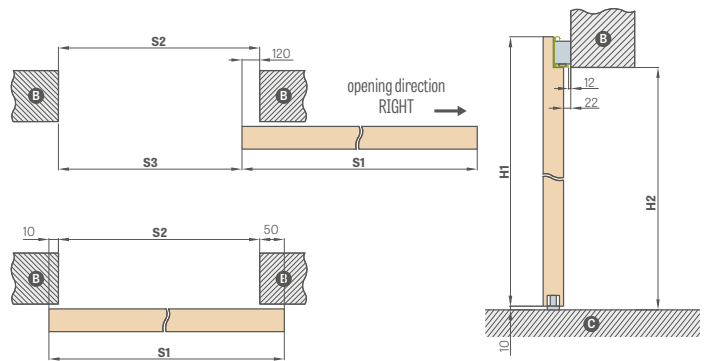

MAGIC WALL-MOUNTED SLIDING DOOR SYSTEM						
		"60"	"70"	"80"	"90"	"100"
S1	Door leaf width	644	744	844	944	1044
S2	Width of the opening in the wall	584	684	784	884	984
S3	Clear opening	464	564	664	764	864
H1	Door leaf height	2150	2150	2150	2150	2150
H2	Height of the opening in the wall	2100	2100	2100	2100	2100

B - wall C - floor

MAGIC DOOR LEAF		
PREMIUM / CPL	CPL 0.2	UV LACQUER

			1)"/>	

### ROUND, OVAL, RECTANGULAR METAL HANDLES

shiny chrome, brushed chrome, shiny brass, matt black



EDGE FINISH OF THE DOOR LEAF BLACK SMOOTH



EDGE FINISH OF THE DOOR LEAF BLACK TRANSVERSE

<sup>1)</sup> smooth white laminate imitating a painted surface

<sup>2)</sup> special **AntiFinger** coating **NEW** limiting dirt and fingerprints

<sup>3)</sup> while stocks last

# WALL-MOUNTED SLIDING DOOR SYSTEM

## GRAF GLASS DOORS



GRAF SYSTEM 61

Sliding system for glass doors with an aluminum cover anodized in silver or powder-coated in black matt.

This system is complete and used for a finished opening as a tunnel is not available. All GRAF glass panes from pages 68-71 are available in the system, as well as those listed on the website [www.erkado.pl](http://www.erkado.pl) and in the B2B panel.

The complete system consists of: GRAF SLIDING SYSTEM + GRAF GLASS PANE + pull handle + one-way soft closer

### GLASS DOOR SLIDING SYSTEM

- silver anodized
- black matt

glass pane:

GRAF SYSTEM 8

GRAF SYSTEM 9

GRAF SYSTEM 11, 32, 33, 35, 36, 38, 39, 61, 62

GRAF SYSTEM 65 VSG/ESG glass black opaque

GRAF SYSTEM 66 VSG/ESG glass milky

double-sided round pull handle stainless steel

double-sided round pull handle stainless steel black matt

double-sided round handle anodized aluminum color inox or black matt (powder-coated)

surcharge for "90" glass pane

soft closer

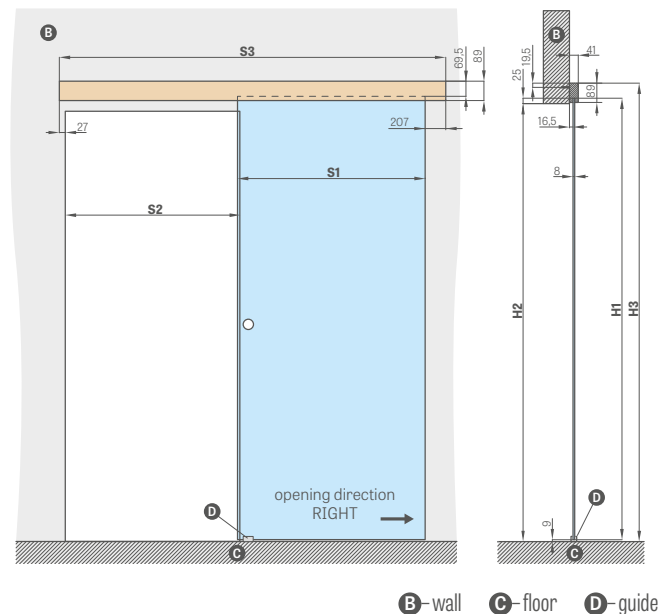

B - wall C - floor D - guide

WALL-MOUNTED SLIDING DOOR SYSTEM FOR GLASS DOORS					
		"60"	"70"	"80"	"90"
S1	Door leaf width	662	762	862	962
S2	Width of the opening in the wall	602	702	802	902
S3	Guide length	1500	1500	1800	2000
H1	Door leaf height	2036			
H2	Height of the opening in the wall	max. 2020			
H3	Total system height	2114			

### PULL HANDLE



stainless steel, black matt  
(outer diameter 54 mm)







anodized aluminum inox, black matt  
powder-coated  
(outer diameter 65 mm)

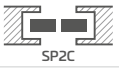

# SLIDING SYSTEMS

## POCKET SYSTEMS

ERKADO offers the following types of concealed-in-the-wall systems:

BASIC TUNNEL STRUCTURE			GREKO / PREMIUM / ST CPL	UV-PAINTED
SP1C.100		single sliding system concealed in the wall for cassette 100 available only for STILE doors, lacquered door leaves and model ALTAMURA 1, UNO PREMIUM		
SP2C.100		double sliding system concealed in the wall for cassette 100 available only for STILE doors and model ALTAMURA 1, UNO PREMIUM		
SP1C.125		single sliding system concealed in the wall for cassette 125		-
SP2C.125		double sliding system concealed in the wall for cassette 125		-
ZN1		single-sided basic wall enclosure supplement for system SP1C.100 or SP1C.125	price depends on scope (next page)	
ZN2		single-sided basic wall enclosure supplement for system SP2C.100 or SP2C.125	price depends on scope (next page) + 30%	

Systems not available in CPL0.2 and CPL0.7 laminates

$$\text{PRICE OF THE SLIDING SYSTEM} = \text{PRICE OF THE WING} + \text{PRICE OF THE ALUMINUM CASSETTE} + \text{PRICE OF THE BASIC TUNNEL ENCLOSURE} + \text{OPTIONALLY PRICE OF ZN1 OR ZN2 ENCLOSURE}$$

The standard set of single/double wall-concealed systems includes the following elements:

- aluminum cassette [LEON] SP1 – price of cassette for single system
- aluminum cassette [LEON] SP2 – price of cassette for double system
- rebate-free door leaf / two rebate-free door leaves – price of standard door leaf / price of two door leaves
- basic tunnel enclosure (table above)
- tunnel enclosure ZN1 or ZN2 – see table on next page

### EXTRA CHARGES

connection at a 90-degree angle

#### hook bolt lock with hardware<sup>2)</sup>

available only for: SP1C.100, SP1C.125

#### oval, rectangular, or round pull handle

in colors: shiny chrome, brushed chrome, shiny brass, matt black.

available for SP1C.100, SP2C.100, SP1C.125, SP2C.125

set of handles consists of two pieces.

#### finger pull

in colors: shiny chrome, brushed chrome, shiny brass, matt black

#### synchronization

simultaneous opening or closing of two door leaves is possible only with one door leaf  
available only for: SP2C.100, SP2C.125

#### crosshead and pilasters

#### damper<sup>3)</sup>

automatic door leaf deceleration in the final phase of closing; available only for SP1C.100, SP1C.125

#### standard 2112

surcharge for the door leaf in standard 2112, cassette and enclosure

+ 15%

### ROUND, OVAL, RECTANGULAR HANDLES<sup>1)</sup>

shiny chrome, brushed chrome, shiny brass, matt black



### HOOK LOCKS WITH KEY

shiny chrome, brushed chrome, shiny brass, black matt



The key is only available in silver color

The hook lock with key includes two selected handles

<sup>1)</sup> in the BALDUR 8 model, the oval and square pull handle overlaps the milling

<sup>2)</sup> NOTE: the height of the oval handle for the key / WC variant is different and amounts to: key: 1006 mm, WC option: 1015 mm (dimension measured from the bottom edge of the door leaf)

<sup>3)</sup> use only on one side

<sup>4)</sup> when using a WC lock in the system for 100 mm cassette, the door leaf does not retract completely into the opening as it is limited by the lock knob

Range of single-sided adjustment of the basic wall min.-max (mm)	WALL ENCLOSURE IN SINGLE-LEAF DOOR SYSTEM ON ONE SIDE ZN1		
	GREKO	PREMIUM and ST CPL	UV-PAINTED <b>NEW</b>
0-40; 40-60; 60-80;			
80-100; 100-120; 120-140			
140-160; 160-180; 180-200			
200-220; 220-240			
240-260; 260-280			
280-300; 300-320			
320-340; 340-360			

- system including one side of wall casing for double doors ZN2 + 30% to the prices from the table above
- standard 2112 surcharge + 15%

		SINGLE AND DOUBLE SLIDING SYSTEMS RECESSED INTO THE WALL									
		"60"	"70"	"80"	"90"	"100"	2 x "60"	2 x "70"	2 x "80"	2 x "90"	2 x "100"
<b>S1</b>	Door leaf width	644	744	844	944	1044	1288	1488	1688	1888	2088
<b>S2</b>	Clear width of the frame	604	704	804	904	1004	1204	1404	1604	1804	2004
<b>S3</b>	Width of the cassette	1318	1518	1718	1918	2118	2538	2938	3338	3738	4138
<b>S4</b>	Door frame coverage width architrave 6 cm / architrave 8 cm	746 / 786	846 / 886	946 / 986	1046 / 1086	1146 / 1186	1346 / 1386	1546 / 1586	1746 / 1786	1946 / 1986	2146 / none
<b>S5</b>	Width of the opening in the cassette	655	755	855	955	1055	1255	1455	1655	1855	2055
<b>S6</b>	Width of the opening in the wall	1338	1538	1738	1938	2138	2558	2958	3358	3758	4158
<b>H1</b>	Door leaf height	2030 (2112) <sup>1</sup>									
<b>H2</b>	Door frame coverage height architrave 6 cm / architrave 8 cm	2092 / 2112 (2174 / 2194) <sup>1</sup>									2092 / none (2174 / none) <sup>1</sup>
<b>H3</b>	Height of the cassette	2115 (2197) <sup>1</sup>									
<b>H4</b>	Clear height of the frame	2021 (2103) <sup>1</sup>									
<b>H5</b>	Height of the opening in the wall	2125 (2207) <sup>1</sup>									

<sup>1</sup>) standard PL2112

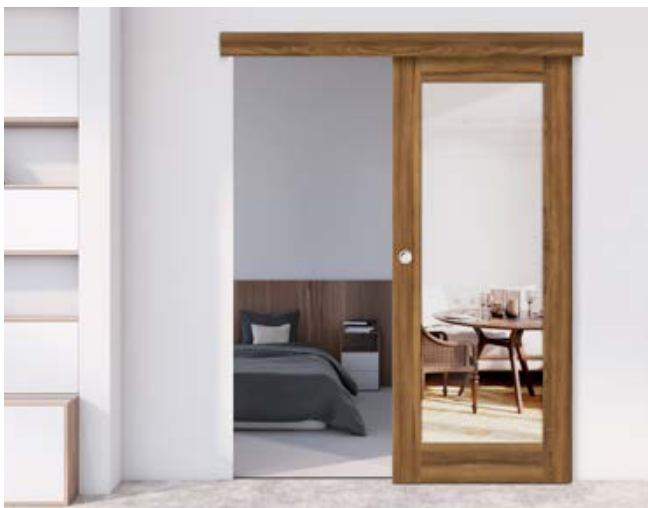

The photo shows a wall-mounted sliding door system.



In the photo, a sliding system recessed into the wall



# SINGLE AND DOUBLE DOOR SYSTEMS

## POCKET SYSTEMS

### SP1C.100 (left glazing obverse)

fixed range 100 mm

cassette thickness before drywall installation - 75 mm

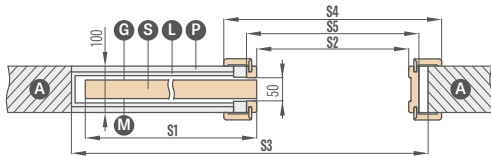

Only for the UNO PREMIUM, ALTAMURA 1 models and for all frame door leaves. The system does not include and does not require dust brushes.

### SP1C.125 (left glazing obverse)

fixed range 125 mm

cassette thickness before drywall installation - 100 mm

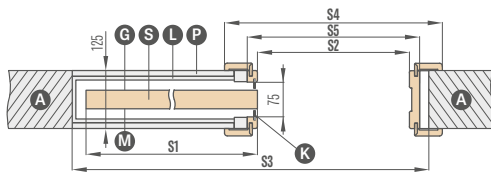

For use only with panel door leaves that have a glazing bead. The system includes grey dust brushes.

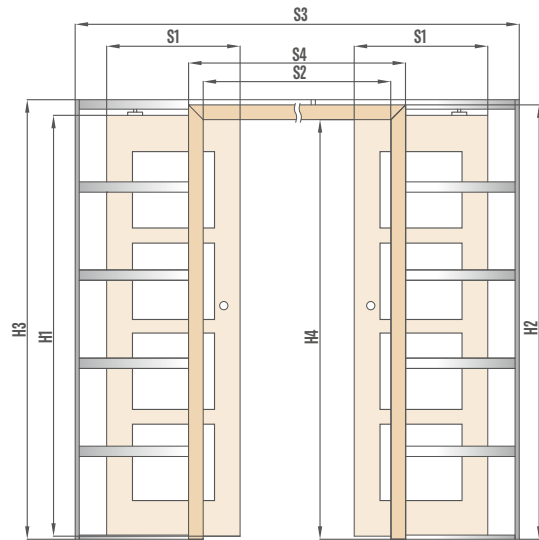
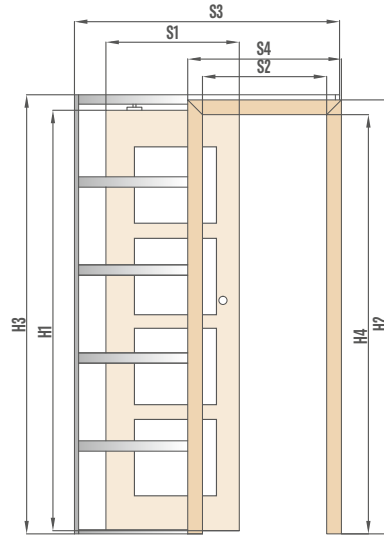

- A** - wall
- L** - aluminum cassette
- P** - gypsum board
- K** - dust brushes
- G** - smooth side of the glass
- M** - matt side of the glass
- S** - door leaf

### ZN1 single-sided casing of the basic wall for SP1C.100 and SP1C.125

range of basic wall casing from 0-40; 40-60; ... 340-360

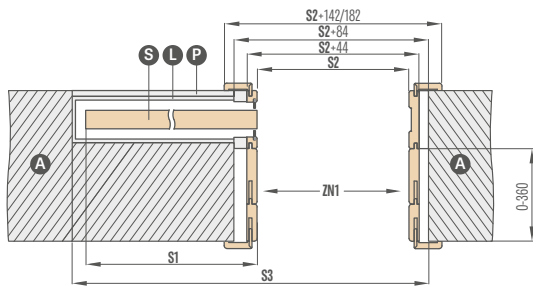

The sketch shows a single-sided casing of the basic wall ZN1.

### SP2C.100 (glazing obverse)

fixed range 100 mm

cassette thickness before drywall installation - 75 mm

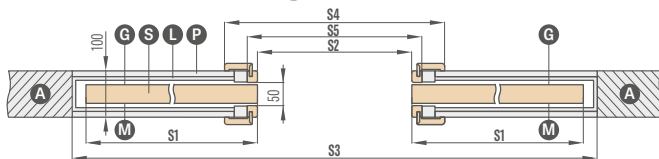

Only for the UNO PREMIUM, ALTAMURA 1 models and for all frame door leaves. The system does not include and does not require dust brushes.

### SP2C.125 (glazing obverse)

fixed range 125 mm

cassette thickness before drywall installation - 100 mm

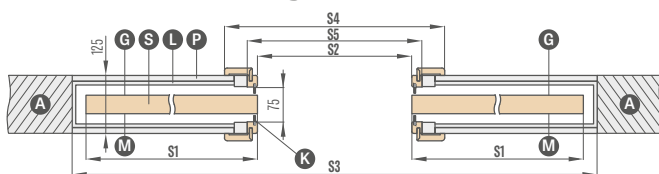

For use only with panel door leaves that have a glazing bead. The system includes grey dust brushes.

### ZN2 single-sided casing of the basic wall for SP2C.100 and SP2C.125

range of basic wall casing from 0-40; 40-60; ... 340-360

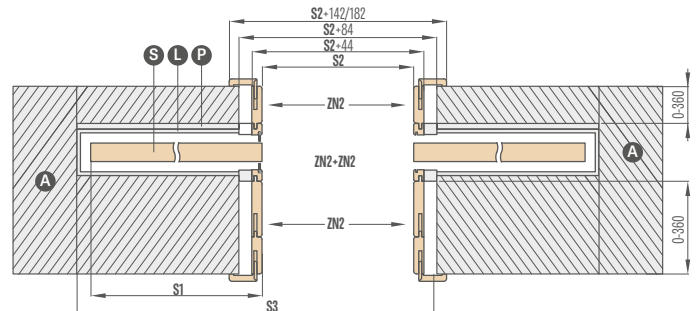

The sketch shows a double-sided casing of the basic wall ZN2 + ZN2.

# DOUBLE-LEAF DOORS

REBATED and NON-REBATED

## PRACTICAL INFORMATION:

### DOUBLE-LEAF DOORS



- In double-leaf doors, solid core filling is available for an extra charge.
- Double-leaf doors are made based on available models of single-leaf door flush and stile doors with corresponding features: color; finish (STANDARD, SOFT), glazing, etc.
- Double-leaf doors available in CPL 0.2 and CPL 0.7
- The inactive door leaf is equipped with door bolts.
- The inactive door leaf below width "60" is available only as a full smooth panel - extension (see drawing below).
- Extensions are made in flush technology with STANDARD edge. They are available with honeycomb filling or, for an extra charge, with solid core. Extensions have vertical grain.
- The active and inactive door leaves are equipped with meeting stiles.
- Meeting stiles in CPL 0.7 door leaves are laminated CPL 0.2
- Double-leaf doors in non-rebated technology are available only with a magnetic lock.
- Non-rebated double-leaf doors are available only with an adjustable frame.
- Electric strike is not available in double-leaf doors
- standard PL2112 for selected door leaves

## AVAILABLE DOOR LEAF WIDTHS:

- Flush and stile DOUBLE-LEAF DOOR from "120" to "190"\*\*\* and combinations with full smooth extension

60 + 30*	70 + 30*	80 + 30*	90 + 30*	100 + 30*
60 + 40*	70 + 40*	80 + 40*	90 + 40*	100 + 40*
60 + 50*	70 + 50*	80 + 50*	90 + 50*	100 + 50*

\* Extension available only in standard technology as full smooth

\*\* Up to "180" for non-rebated

## PRICE OF DOUBLE-LEAF DOORS:

- Flush and stile: active door leaf **60 70 80 90 100** + inactive door leaf **60 70 80 90\***

$$\text{price of double-leaf doors with meeting stile} = \text{door leaf price} \times 2 + \text{lippings}$$

- Flush and stile: active door leaf **60 70 80 90 100** + full smooth inactive extensions **30 40 50**

$$\text{price of double-leaf doors with extension and meeting stile} = \text{door leaf price} + \text{full extension with meeting stiles}$$

- Price of fixed and adjustable door frame for double-leaf doors + 30%
- Extra charge for solid core in extension
- UV lacquered extension only full smooth

\* does not apply to non-rebated door leaves

# DOUBLE-LEAF DOORS

## NON-REBATED

### NON-REBATED DOUBLE-LEAF DOORS WITH ADJUSTABLE FRAME

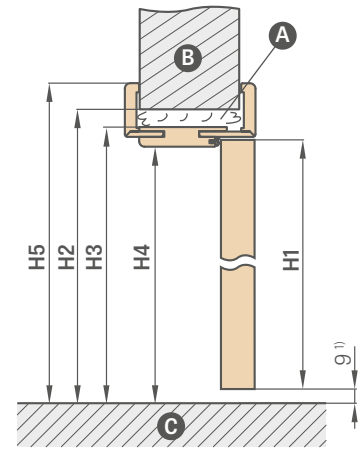
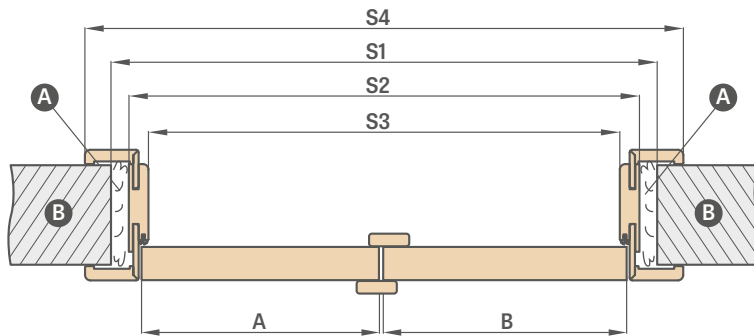

**A** - foam **B** - wall **C** - floor

<sup>1)</sup> permissible deviation resulting from frame dimensional tolerance +- 3mm (we recommend checking before installation)

Adjustable door frame		NON-REBATED DOUBLE-LEAF DOORS									
		"90"	"100"	"110"	"120"	"130"	"140"	"150"	"160"	"170"	"180"
<b>A+B</b>	Door leaf width	988	1088	1188	1288	1388	1488	1588	1688	1788	1888
<b>S1</b>	Width of the opening in the wall	1061	1161	1261	1361	1461	1561	1661	1761	1861	1961
<b>S2</b>	External width of the frame	1021	1121	1221	1321	1421	1521	1621	1721	1821	1921
<b>S3</b>	Clear width of the frame	977	1077	1177	1277	1377	1477	1577	1677	1777	1877
<b>S4</b>	Frame coverage width architrave 6 cm / architrave 8 cm	1119 / 1159	1219 / 1259	1319 / 1359	1419 / 1459	1519 / 1559	1619 / 1659	1719 / 1759	1819 / 1859	1919 / 1959	2019 / 2059
<b>H1</b>	Door leaf height	2030 (2112) <sup>2)</sup>									
<b>H2</b>	Height of the opening in the wall	2073 (2155) <sup>2)</sup>									
<b>H3</b>	External height of the frame	2053 (2135) <sup>2)</sup>									
<b>H4</b>	Clear height of the frame	2031 (2113) <sup>2)</sup>									
<b>H5</b>	Frame covering height architrave 6 cm / architrave 8 cm	2102 / 2122 (2184 / 2204) <sup>2)</sup>									

DOUBLE-LEAF DOORS  
- SYMMETRICAL



DOUBLE-LEAF DOORS  
- ASYMMETRICAL



DOUBLE-LEAF DOORS  
- WITH FULL SMOOTH EXTENSION



<sup>2)</sup> standard PL2112

# DOUBLE-LEAF DOORS

## REBATED

### REBATED DOUBLE-LEAF DOORS WITH ADJUSTABLE FRAME

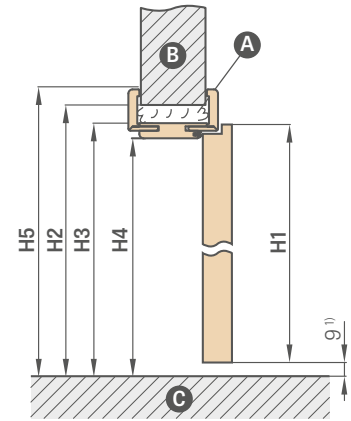
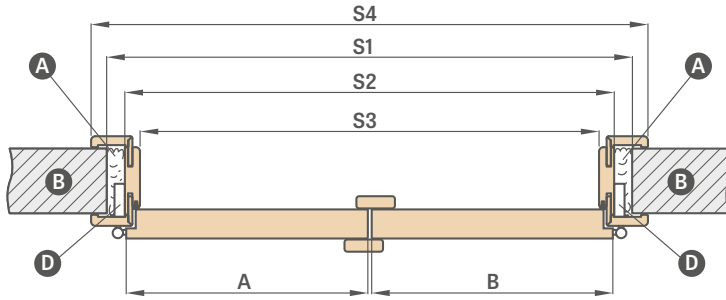

A-foam B-wall C-floor D-hinge socket

Adjustable door frame		DOUBLE-LEAF DOORS										
		"90"	"100"	"110"	"120"	"130"	"140"	"150"	"160"	"170"	"180"	"190"
A+B	Door leaf width	988	1088	1188	1288	1388	1488	1588	1688	1788	1888	1988
S1	Width of the opening in the wall	1034	1134	1234	1334	1434	1534	1634	1734	1834	1934	2034
S2	External width of the frame	994	1094	1194	1294	1394	1494	1594	1694	1794	1894	1994
S3	Clear width of the frame	950	1050	1150	1250	1350	1450	1550	1650	1750	1850	1950
S4	Door frame coverage width architrave 6 cm / architrave 8 cm	1092 / 1132	1192 / 1232	1292 / 1332	1392 / 1432	1492 / 1532	1592 / 1632	1692 / 1732	1792 / 1832	1892 / 1932	1992 / 2032	2092 / 2132
H1	Door leaf height	2030 (2112) <sup>2</sup>										
H2	Height of the opening in the wall	2060 (2142) <sup>2</sup>										
H3	External height of the frame	2040 (2122) <sup>2</sup>										
H4	Clear height of the frame	2018 (2100) <sup>2</sup>										
H5	Frame covering height architrave 6 cm / architrave 8 cm	2089 / 2109 (2171 / 2191) <sup>2</sup>										

### REBATED DOUBLE-LEAF DOORS WITH FIXED FRAME

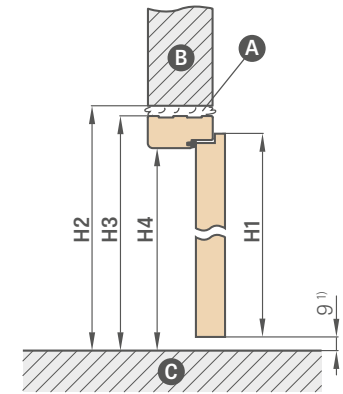
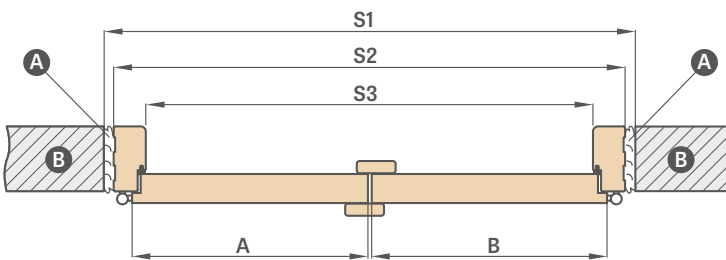

A-foam B-wall C-floor

Fixed door frame		DOUBLE-LEAF DOORS										
		"90"	"100"	"110"	"120"	"130"	"140"	"150"	"160"	"170"	"180"	"190"
A+B	Door leaf width	988	1088	1188	1288	1388	1488	1588	1688	1788	1888	1988
S1	Width of the opening in the wall	1068	1168	1268	1368	1468	1568	1668	1768	1868	1968	2068
S2	External width of the frame	1038	1138	1238	1338	1438	1538	1638	1738	1838	1938	2038
S3	Clear width of the frame	950	1050	1150	1250	1350	1450	1550	1650	1750	1850	1950
H1	Door leaf height	2030										
H2	Height of the opening in the wall	2077										
H3	External height of the frame	2062										
H4	Clear height of the frame	2018										

<sup>1)</sup> permissible deviation resulting from frame dimensional tolerance +- 3mm (we recommend checking before installation)

<sup>2)</sup> standard PL2112



# FOLDING DOORS



## DESIGN

- a door leaf consisting of two parts connected by concealed hinges
- internal MDF frame covered with two HDF boards
- optional, for an additional fee, internal wooden stile (sides and top, bottom MDF) covered with two HDF boards
- stabilizing "honeycomb" filling or, for an extra charge, solid board filling
- the door frame with a range above 320 mm consists of two elements, and above 400 mm of three elements.

## FINISH

- HDF board covered with laminate
- STANDARD door leaf edge
- edge finished with edging in the color of the surface or optionally in smooth black (in the NATUR OAK TRANSVERSE PREMIUM decor, black edging with transverse structure)

## HARDWARE

- two concealed hinges between the door leaves, painted silver
- guiding system in the upper and lower part of the door
- latch-bolt lock for key, patent insert, economy or with a lock

## EXTRA CHARGES

solid board filling

door leaf "100"

black door leaf edge finish

internal wooden stile (sides and top, bottom MDF)

extra charge for the third hinge

CPL 0.2 door leaf

CPL 0.7 door leaf

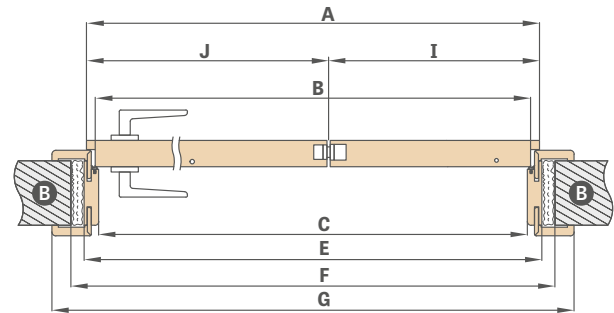
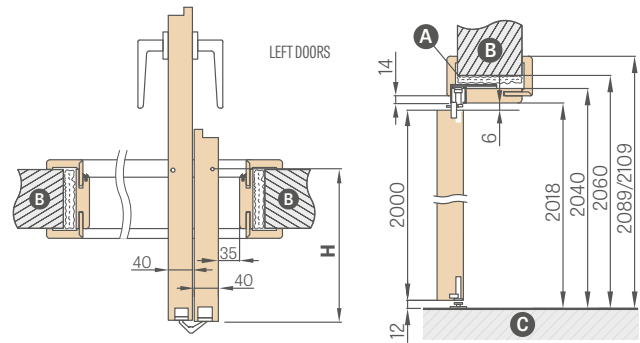
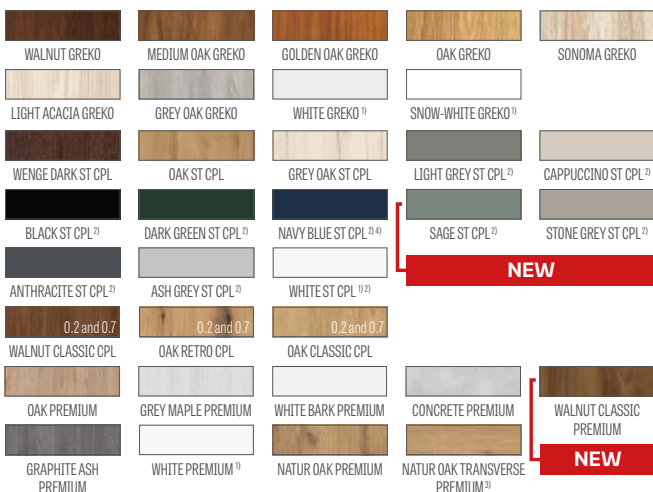

A- foam B- wall C- floor

Door width	A	B	C	E	F	G	H	I	J
"60"	641	614	604	648	688	746*/786**	152,5	218	418
"70"	741	714	704	748	788	846*/886**	202,5	268	468
"80"	841	814	804	848	888	946*/986**	252,5	318	518
"90"	941	914	904	948	988	1046*/1086**	302,5	368	568
"100"	1041	1014	1004	1048	1088	1146*/1186**	352,5	418	618

\*architrave 6 cm / \*\*architrave 8 cm, only 45-degree connection

## AVAILABLE DOOR LEAF WIDTHS

60 70 80 90 100



installation video  
<https://youtu.be/tzccmzy7rvq>

Adjustment range min.-max (mm)
80-100
100-120
120-140
140-160
160-180
180-200
200-220
220-240

Adjustment range min.-max (mm)
240-260
260-280
280-300
300-340
340-360
360-380
380-400
400-420

For every 2 cm, an extra charge (based on the price in the 400-420 mm range) up to the 500-520 mm range

<sup>1)</sup> smooth white laminate imitating a painted surface

<sup>2)</sup> special **AntiFinger** coating limiting dirt and fingerprints

<sup>3)</sup> in the set, the frame is made in the NATUR OAK PREMIUM decor

<sup>4)</sup> while stocks last

# COVERT CONCEALED DOOR SYSTEM

OPENING INWARD AND OUTWARD



## DESIGN

- rebated or non-rebated door leaf
- internal MDF frame covered with two HDF boards
- optional, for an additional fee, internal wooden stile (sides and top, bottom MDF covered with two HDF boards)
- stabilizing "honeycomb" filling or, for an extra charge, solid board filling

## FINISH

- HDF board covered with PREMIUM laminate, ST CPL, UV lacquer or laminate intended for painting or wallpapering
- door leaf edge made in rebated or non-rebated technology

## HARDWARE

- two concealed hinges recessed in the frame (third optionally for an extra charge)
- magnetic lock in rebated and non-rebated door leaf for key, patent insert, economy or with a lock

## EXTRA CHARGES

frame in white or black color<sup>3)</sup>

UV lacquered door leaf

solid board filling

additional bottom beam in the door leaf (possibility to shorten on your own to max 8 cm)

round and square metal sleeves (4 pcs.)

finish: brushed nickel, patina, white and black

wood-like plastic sleeves (4 pcs.)

enhanced airflow trim standard or mini, ventilation undercut standard or mini (p. 153) or ventilation grille

third hinge

replacement in the door leaf with a magnetic lock in black color

replacement with hinges and strike plate in black color

- for two hinges or

- for three hinges

black door leaf edge finish

door leaf "100"

internal wooden stile (sides and top, bottom MDF)

drop-down seal

LUX inlay, version to choose on pp. 100-107

standard 2112 - extra charge for door leaf and frame

## REBADED AND NON-REBADED DOOR LEAF

## CONCEALED ALUMINUM FRAME



## AVAILABLE DOOR LEAF WIDTHS

60 70<sup>5)</sup> 80<sup>5)</sup> 90 100

<sup>1)</sup> smooth white laminate imitating a painted surface

<sup>2)</sup> used for wallpapering and painting

<sup>3)</sup> as standard, frame in aluminum color

<sup>5)</sup> WHITE PRIMER door leaves and aluminum frame in width "70" and "80" available in a short delivery time, details at the seller

<sup>6)</sup> special **AntiFinger** coating limiting dirt and fingerprints

<sup>7)</sup> while stocks last

# COVERT CONCEALED DOOR SYSTEM

## REBATED DOOR LEAF OPENING INWARDS

### STANDARD DIMENSIONS FOR REBATED DOORS OPENING INWARDS

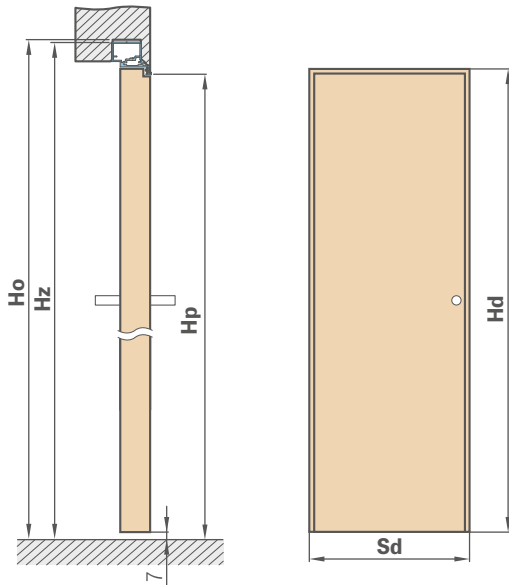

Door leaf width	Width of the construction opening	External width of the frame	Clear passage width
Sd [mm]	So [mm]	Sz [mm]	Sp [mm]
620	700	690	605
720	800	790	705
820	900	890	805
920	1000	990	905
1020	1100	1090	1005

Door leaf height	Height of the construction opening	External height of the frame	Clear passage height
Hd [mm]	Ho [mm]	Hz [mm]	Hp [mm]
2030 (2112) <sup>1)</sup>	2079 (2162) <sup>1)</sup>	2072 (2154) <sup>1)</sup>	2030 (2112) <sup>1)</sup>

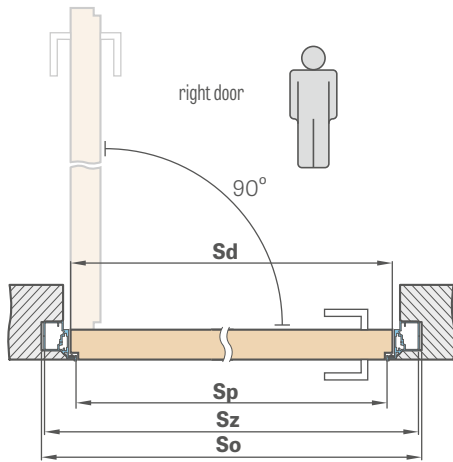

### GYPNUM BOARD INSTALLATION

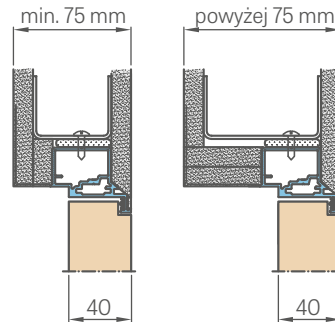

### CROSS-SECTION OF ALUMINUM FRAME

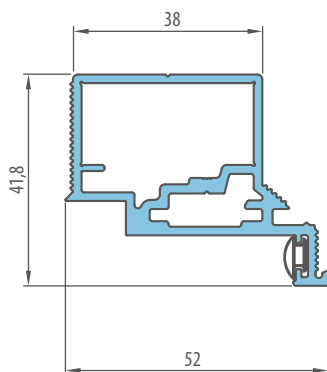

### ENCLOSED IN WALL

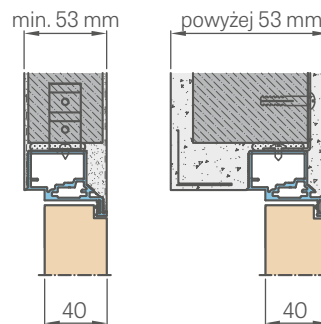

# COVERT CONCEALED DOOR SYSTEM

UNREBATED DOOR LEAF OPENING OUTWARDS

## STANDARD DIMENSIONS FOR UNREBATED DOORS OPENING OUTWARDS

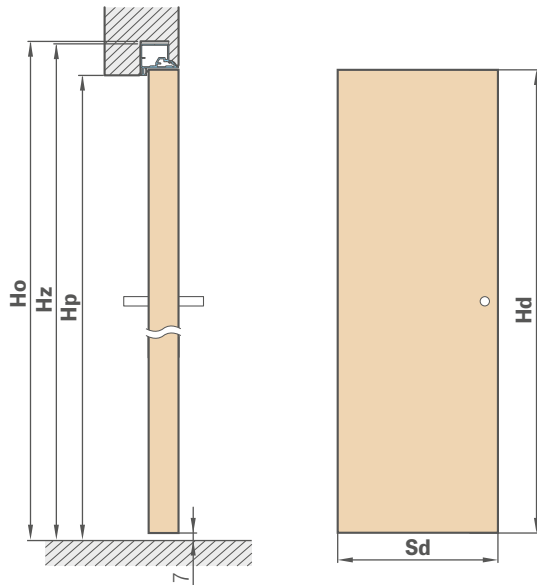

Door leaf width	Width of the construction opening	External width of the frame	Clear passage width
Sd [mm]	So [mm]	Sz [mm]	Sp [mm]
620	700	690	605
720	800	790	705
820	900	890	805
920	1000	990	905
1020	1100	1090	1005

Door leaf height	Height of the construction opening	External height of the frame	Clear passage height
Hd [mm]	Ho [mm]	H <sub>z</sub> [mm]	H <sub>p</sub> [mm]
2020 (2102) <sup>1)</sup>	2069 (2152) <sup>1)</sup>	2062 (2144) <sup>1)</sup>	2020 (2102) <sup>1)</sup>

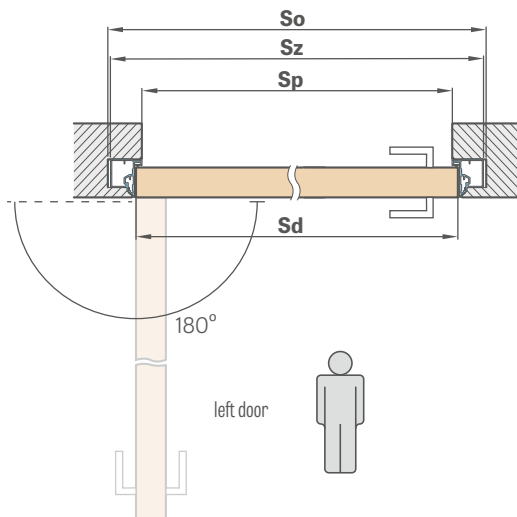

## GYPHUM BOARD INSTALLATION

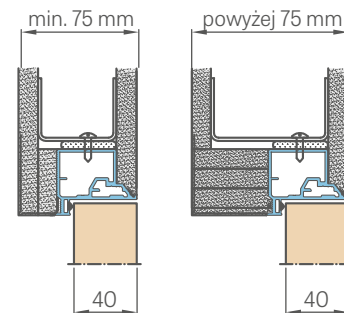

## CROSS-SECTION OF ALUMINUM FRAME

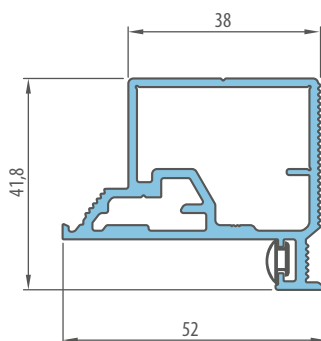

## ENCLOSED IN WALL

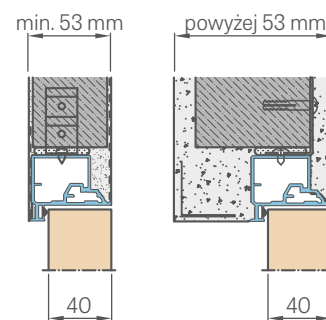

<sup>1)</sup> standard PL2112

# SIDELIGHTS FOR DOORS

## REBATED

### GENERAL INFORMATION

Sidelights are factory-assembled and glazed with VSG 331 safety glass, either frosted or clear. (Please specify the type of glass when ordering).

To connect the sidelights with the doors, specifically with the adjustable or fixed frame, additional structural elements (e.g. wooden posts) may be required, which the installer selects and arranges on their own depending on the opening conditions. ERKADO does not sell such elements.

### SIDE LIGHT PRICES

SIDE LIGHT FOR REBATED SINGLE-LEAF AND DOUBLE-LEAF DOORS					
Height	Frame	Width			
		"30"	"40"	"50"	"60"
PL	adjustable**				
Standard	fixed				

CORNER SIDELIGHT FOR REBATED SINGLE-LEAF AND DOUBLE-LEAF DOORS					
Height	Frame	Width			
		"30"	"40"	"50"	"60"
"30"	adjustable**				
	fixed				
"40"	adjustable**				
	fixed				
"50"	adjustable**				
	fixed				
"60"	adjustable**				
	fixed				

TOP SIDELIGHT FOR REBATED SINGLE-LEAF DOORS						
Height	Frame	Width				
		"60"	"70"	"80"	"90"	"100"
"30"	adjustable**					
	fixed					
"40"	adjustable**					
	fixed					
"50"	adjustable**					
	fixed					
"60"	adjustable**					
	fixed					

TOP LIGHT FOR DOUBLE-LEAF REBATED DOORS												
Height	Frame	Width										
		"90"	"100"	"110"	"120"	"130"	"140"	"150"	"160"	"170"	"180"	"190"
"30"	adjustable**											
	fixed											
"40"	adjustable**											
	fixed											
"50"	adjustable**											
	fixed											
"60"	adjustable**											
	fixed											

### SIDE LIGHT DIVISION

FOR <b>BLOCK FRAME</b>
FOR <b>ADJUSTABLE FRAME</b>
FOR <b>SINGLE-LEAF DOORS</b>
FOR <b>DOUBLE-LEAF DOORS</b>

### AVAILABLE CONFIGURATIONS

#### SINGLE-LEAF REBATED DOORS with side, top, and corner sidelights

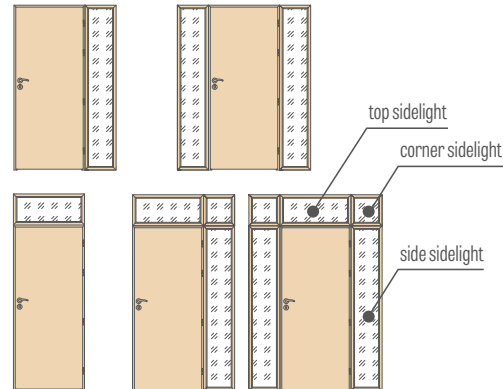

#### DOUBLE-LEAF REBATED DOORS with side, top, and corner sidelights

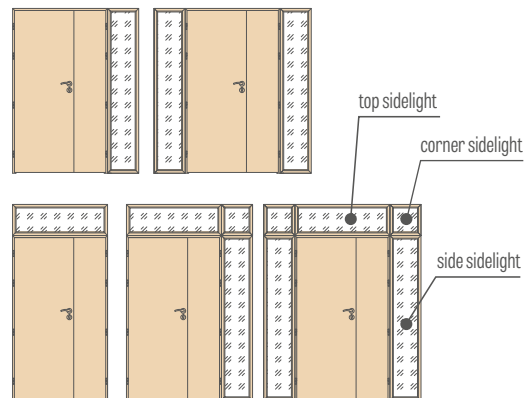

\*\* The ranges are available as for standard adjustable rebated frames, pp. 186-187

The price includes a VSG 331 matt or VSG 331 transparent safety glass and is uniform for all laminates and ranges available in rebated frames

The prices apply to sidelights with 6 and 8 cm trims

The price of lacquered sidelights surcharge + 50%

The strips fixing the sidelights are nailed with pins and may (especially in white decors and lacquered sidelights) show small dark spots after nailing

Sidelights are not available in CPL 0.2 and CPL 0.7 laminates

Sidelights for doors for adjustable rebated door frame, architrave 6 cm / architrave 8 cm

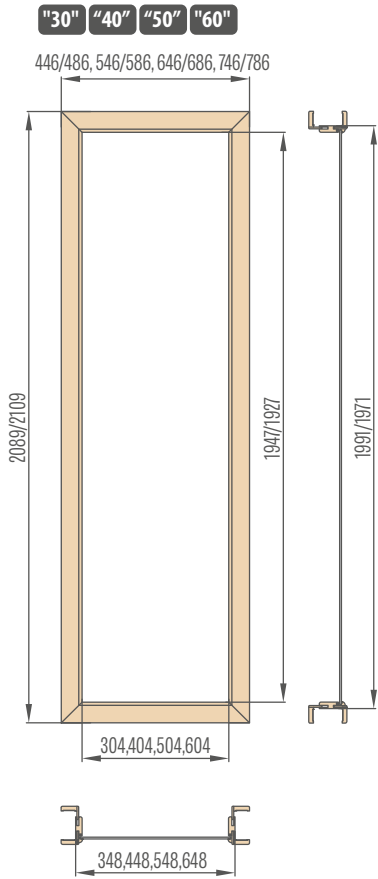

Corner sidelights for doors with adjustable rebated door frame, architrave 6 cm / architrave 8 cm

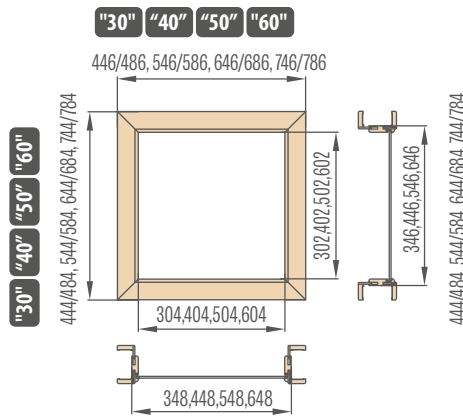

Top sidelights for adjustable door frame of single-leaf rebated doors, architrave 6 cm / architrave 8 cm

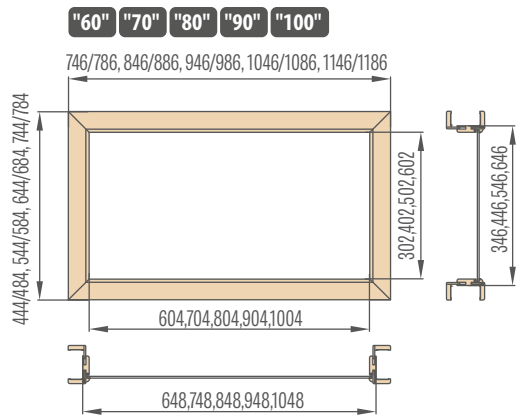

Top sidelights for adjustable door frame of double-leaf rebated doors, architrave 6 cm / architrave 8 cm

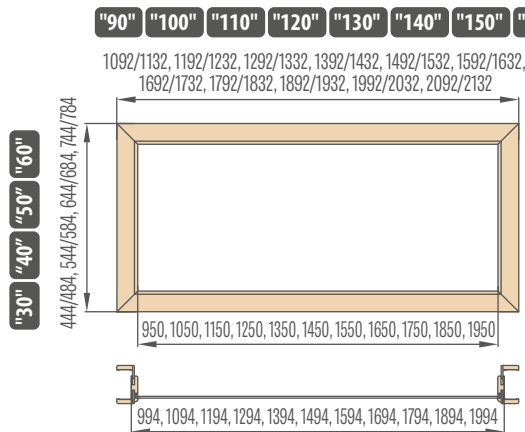

Calculation diagram for the height of the opening in the wall for an adjustable door frame:

- total frame height
- + total sidelight height
- 29 mm (for 60 mm angle bar) or 49 mm (for 80 mm angle bar)

Calculation diagram for the width of the opening in the wall for an adjustable door frame:

- total frame width
- + total sidelight width
- 58 mm (for 60 mm angle bar) or 98 mm (for 80 mm angle bar)

Side sidelights for fixed frame

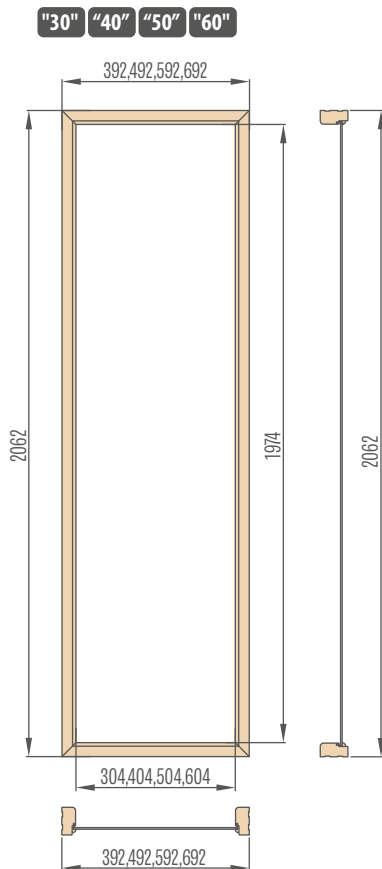

Corner sidelights for fixed frame

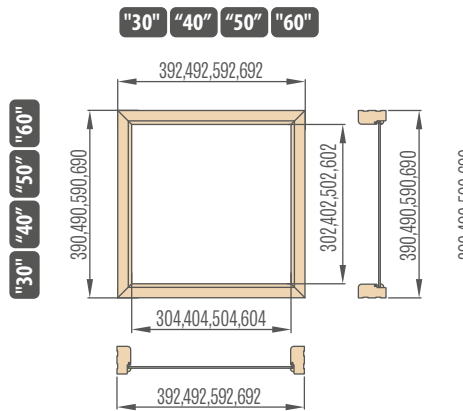

Top sidelights for fixed frame of single-leaf doors

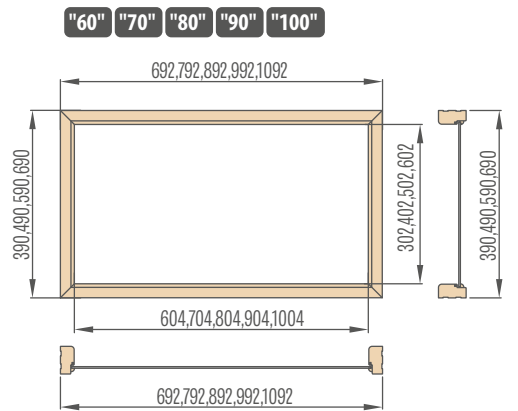

Top sidelights for fixed frame of double-leaf doors

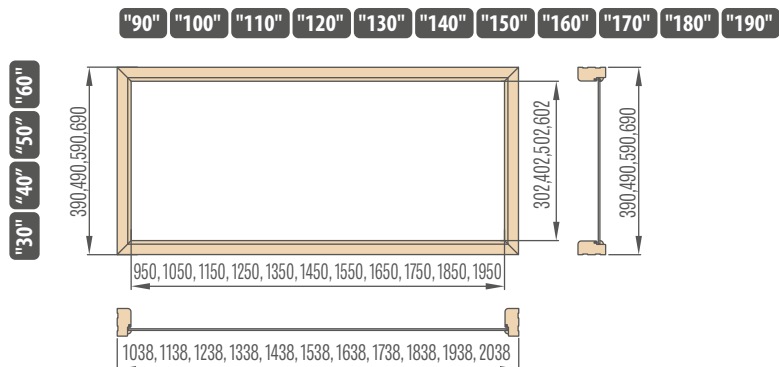



# FRAMES

- The adjustable rebated frame and the fixed rebated frame can be used for all types of ERKADO interior doors made with flush or stile technology.
- The adjustable non-rebated frame can be used for interior doors made with flush or stile technology. These frames have three concealed hinges.
- The frame is made of high-quality MDF and covered with a durable wood-like foil or coated with durable UV lacquer.
- Depending on the technology, the frames are covered with the following types of finishes: GREKO, CPL, PREMIUM, and UV lacquer.
- Frames for STILE frame doors come standard with an additional third hinge.
- Each set of adjustable or fixed frames includes: frame elements (strike upright, hinge upright, and top beam), hinges, and mounting screws. The individual elements have pre-drilled holes at the connection points.
- Each set includes an installation manual and a warranty card.
- The fixed door frame for the Herse collection is rectangular and has a core made of glulam.

**ADJUSTABLE FRAME  
REBATED DOOR LEAVES**



**OVERLAY ADJUSTABLE FRAME  
FOR STEEL FRAME**



**ADJUSTABLE FRAME  
NON-REBATED DOOR LEAVES**



**FIXED DOOR FRAME STAND  
REBATED DOOR LEAVES**



**CLIP-ON SQUARE FOR ADJUSTABLE DOOR FRAME**

architrave 6 cm / architrave 8 cm

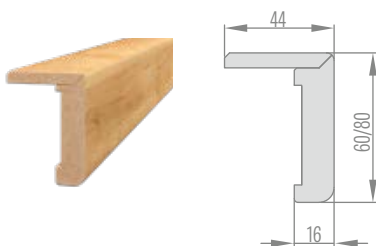

**CLIP-ON SQUARE WITH EXTENDED FEATHER FOR  
ADJUSTABLE DOOR FRAME**

architrave 6 cm / architrave 8 cm

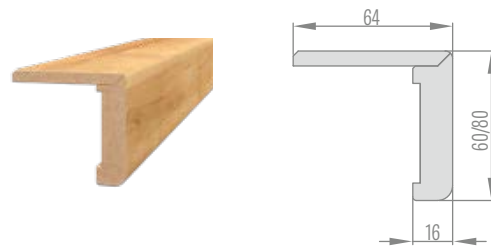

**ADJUSTABLE REBATED FRAME**

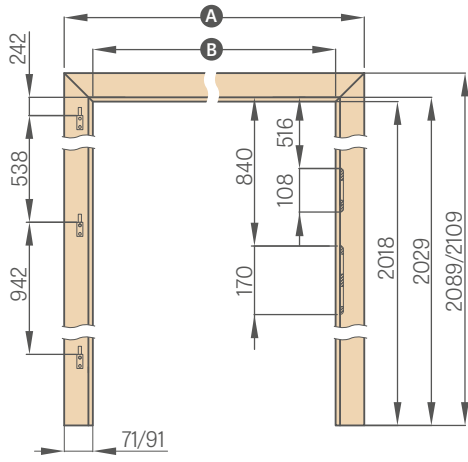

	"60"	"70"	"80"	"90"	"100"	"110"
<b>A</b>	746 / 786	846 / 886	946 / 986	1046 / 1086	1146 / 1186	1246 / 1286
<b>B</b>	604	704	804	904	1004	1104

architrave 6 cm / architrave 8 cm

**ADJUSTABLE NON-REBATED FRAME - PL STANDARD**

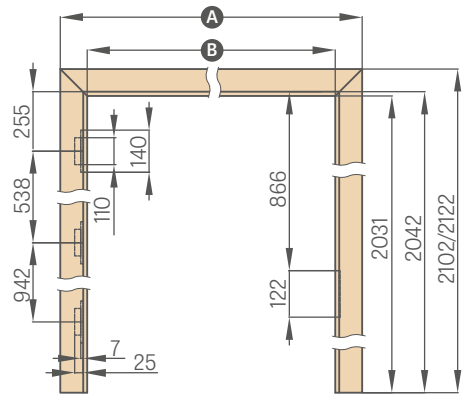

	"60N"	"60"	"70N"	"70"	"80N"	"80"
<b>A</b>	747/787	771 / 811	847/887	871 / 911	947/987	971 / 1011
<b>B</b>	605	629	705	729	805	829

	"90N"	"90"	"100"	"110"
<b>A</b>	1047/1087	1071 / 1111	1171 / 1211	1271/1311
<b>B</b>	905	929	1029	1129

Widths 60N, 70N, 90N available only for models ALTAMURA 1, BALDUR 1, and UNO PREMIUM

**ADJUSTABLE REBATED FRAME - PL2112 STANDARD**

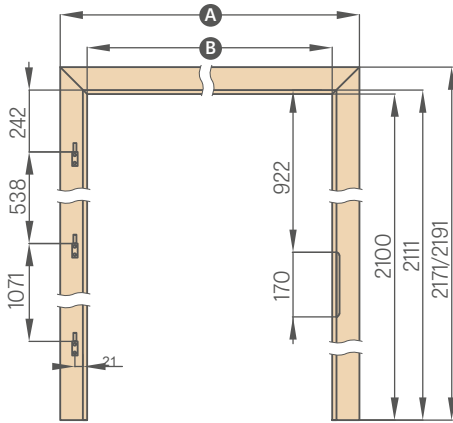

	"60"	"70"	"80"	"90"	"100"	"110"
<b>A</b>	746 / 786	846 / 886	946 / 986	1046 / 1086	1146 / 1186	1246 / 1286
<b>B</b>	604	704	804	904	1004	1104

**ADJUSTABLE NON-REBATED FRAME - PL2112 STANDARD**

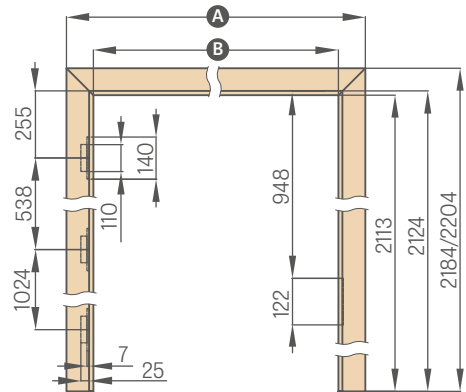

	"60"	"70"	"80N"	"80"	"90"	"100"	"110"
<b>A</b>	771 / 811	871 / 911	947/987	971 / 1011	1071 / 1111	1171 / 1211	1271 / 1311
<b>B</b>	629	729	805	829	929	1029	1129

**TUNNEL-TYPE ADJUSTABLE REBATED FRAME**

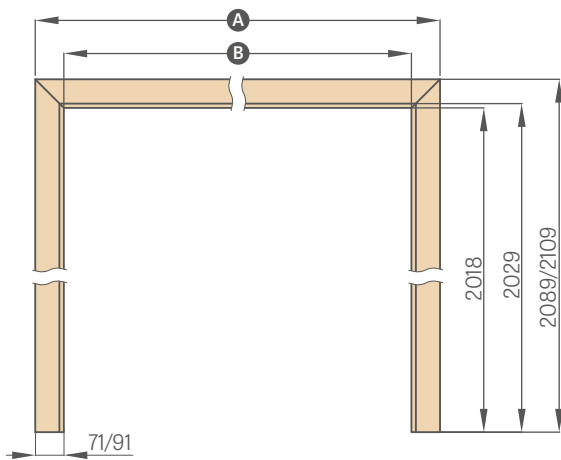

	"60"	"70"	"80"	"90"	"100"	"110"	"120"
<b>A</b>	746 / 786	846 / 886	946 / 986	1046 / 1086	1146 / 1186	1246 / 1286	1346 / 1386
<b>B</b>	604	704	804	904	1004	1104	1204

	"130"	"140"	"150"	"160"	"170"	"180"	"190"
<b>A</b>	1446 / 1486	1546 / 1586	1646 / 1686	1746 / 1786	1846 / 1886	1946 / 1986	2046 / 2086
<b>B</b>	1304	1404	1504	1604	1704	1804	1904

architrave 6 cm / architrave 8 cm

**OVERLAY FRAME**

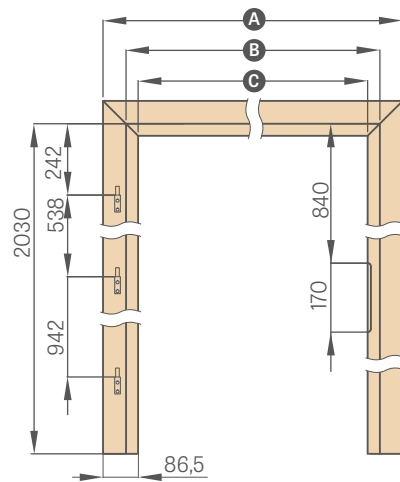

	"60"	"70"	"80"	"90"	"100"
<b>A</b>	737	837	937	1037	1137
<b>B</b>	624	724	824	924	1024
<b>C</b>	564	664	764	864	964

## FIXED DOOR FRAME

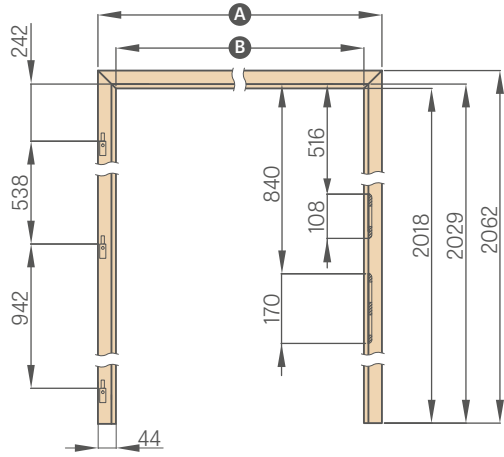

	"60"	"70"	"80"	"90"	"100"	"110"
<b>A</b>	692	792	892	992	1092	1192
<b>B</b>	604	704	804	904	1004	1104

## REVERSIBLE DOOR FRAME

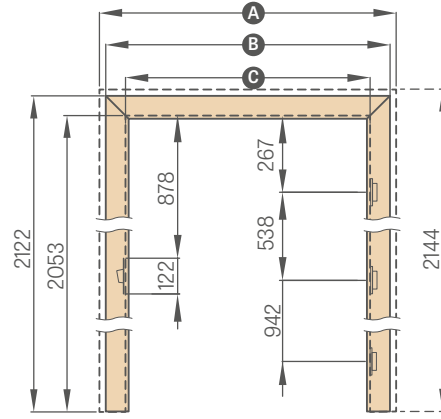

Widths 60N, 70N, 90N available only for models ALTAMURA 1, BALDUR 1, and UNO PREMIUM

	"60N"	"60"	"70N"	"70"	"80N"	"80"	"90N"	"90"	"100"	"110"
<b>A</b>	810	834	910	934	1010	1034	1110	1134	1234	1334
<b>B</b>	766	791	866	891	966	991	1066	1091	1191	1291
<b>C</b>	628	652	728	752	828	852	928	952	1052	1152

## FIXED FRAME FOR DOUBLE-LEAF DOORS

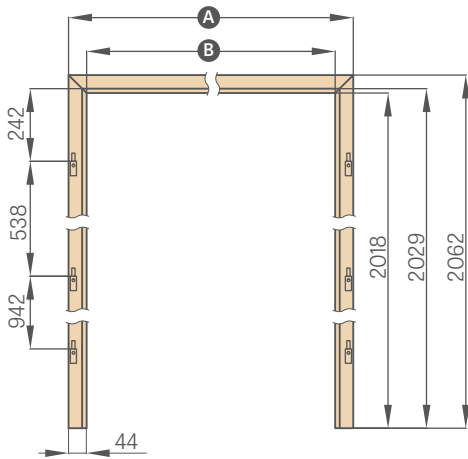

	"90"	"100"	"110"	"120"	"130"	"140"
<b>A</b>	1038	1138	1238	1338	1438	1538
<b>B</b>	950	1050	1150	1250	1350	1450

	"150"	"160"	"170"	"180"	"190"
<b>A</b>	1638	1738	1838	1938	2038
<b>B</b>	1550	1650	1750	1850	1950

## ADJUSTABLE REBATED FRAME FOR DOUBLE-LEAF DOORS

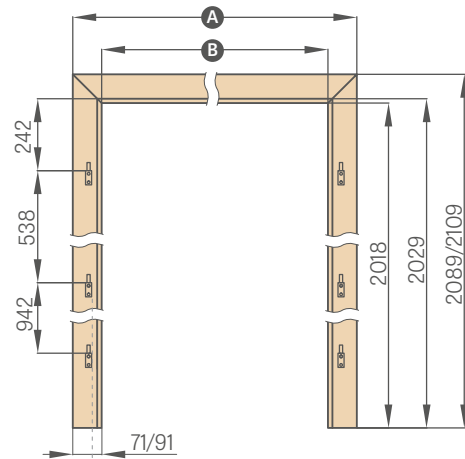

	"90"	"100"	"110"	"120"	"130"	"140"
<b>A</b>	1092/1132	1192/1232	1292/1332	1392/1432	1492/1532	1592/1632
<b>B</b>	950	1050	1150	1250	1350	1450

	"150"	"160"	"170"	"180"	"190"
<b>A</b>	1692/1732	1792/1832	1892/1932	1992/2032	2092/2132
<b>B</b>	1550	1650	1750	1850	1950

architrave 6 cm / architrave 8 cm

## FIXED DOOR FRAME FOR GLASS DOORS

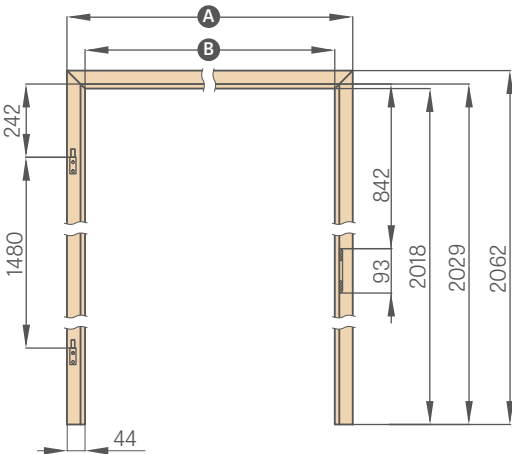

	"60"	"70"	"80"	"90"
<b>A</b>	692	792	892	992
<b>B</b>	604	704	804	904

## ADJUSTABLE REBATED FRAME FOR GLASS DOORS

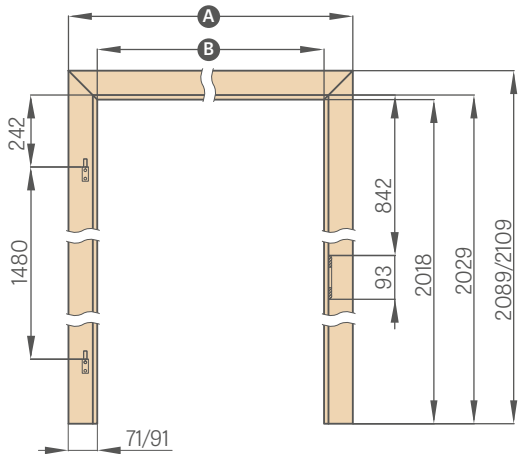

	"60"	"70"	"80"	"90"
<b>A</b>	746/786	846/886	946/986	1046/1086
<b>B</b>	604	704	804	904

architrave 6 cm / architrave 8 cm

In frames for glass panels, a hinge with a 10 mm pin is used

# ADJUSTABLE TUNNEL-TYPE FRAME

## REBATED, NON-REBATED

### TUNNEL FRAMES

A tunnel frame is an adjustable door frame without any fittings. It consists of a top beam and two vertical beams.

It can be used to finish door openings as a protection for wall corners, but it is mainly used for aesthetic purposes as an interior decoration of a given room.

Adjustable rebated tunnel-type frames are also used in ERKADO sliding systems.

Adjustable non-rebated tunnel-type frames are not used for sliding systems.

Depending on the system, we use rebated tunnels:

<b>TUNNEL FOR SP1N</b>	Single wall-mounted sliding system
<b>TUNNEL FOR SP2N</b>	Double wall-mounted sliding system
<b>TUNNEL FOR SP1C.100</b>	Single sliding system concealed in the wall for cassette 100
<b>TUNNEL FOR SP2C.100</b>	Double sliding system concealed in the wall for cassette 100
<b>TUNNEL FOR SP1C.125</b>	Single sliding system concealed in the wall for cassette 125
<b>TUNNEL FOR SP2C.125</b>	Double sliding system concealed in the wall for cassette 125
<b>ZN1 construction</b>	Wall construction on one side for single-leaf door systems SP1C.100 and SP1C.125
<b>ZN2 construction</b>	Wall construction on one side for double-leaf door systems SP2C.100 and SP2C.125

### ADJUSTABLE REBATED TUNNELS

	"60"	"70"	"80"	"90"	"100"	"110"	"120"	"130"	"140"	"150"	"160"	"170"	"180"	"190"
Width of the opening in the wall	688	788	888	988	1088	1188	1288	1388	1488	1588	1688	1788	1888	1988
External width of the tunnel	648	748	848	948	1048	1148	1248	1348	1448	1548	1648	1748	1848	1948
Clear width of the tunnel	604	704	804	904	1004	1104	1204	1304	1404	1504	1604	1704	1804	1904
Coverage width of the tunnel architrave 6 cm / architrave 8 cm	746/786	846/886	946/986	1046/1086	1146/1186	1246/1286	1346/1386	1446/1486	1546/1586	1646/1686	1746/1786	1846/1886	1946/1986	2046/2086
Height of the opening in the wall	2060 (2142) <sup>1)</sup>													
External height of the tunnel	2040 (2122) <sup>1)</sup>													
Clear height of the tunnel	2018 (2100) <sup>1)</sup>													
Coverage height of the tunnel architrave 6 cm / architrave 8 cm	2089 / 2109 (2171 / 2191) <sup>1)</sup>													

### ADJUSTABLE NON-REBATED TUNNELS

	"60"	"70"	"80N"	"80"	"90"	"100"	"110"	"120"	"130"	"140"	"150"	"160"	"170"	"180"
Width of the opening in the wall	713	813	888	913	1013	1113	1213	1313	1413	1513	1613	1713	1813	1913
External width of the tunnel	673	773	849	873	973	1073	1173	1273	1373	1473	1573	1673	1773	1873
Clear width of the tunnel	629	729	805	829	929	1029	1129	1229	1329	1429	1529	1629	1729	1829
Coverage width of the tunnel architrave 6 cm / architrave 8 cm	771/ 811	871/ 911	947/ 987	971/ 1011	1071/ 1111	1171/ 1211	1271/ 1311	1371/ 1411	1471/ 1511	1571/ 1611	1671/ 1711	1771/ 1811	1871/ 1911	1971/ 2011
Height of the opening in the wall	2073 (2155) <sup>1)</sup>													
External height of the tunnel	2053 (2135) <sup>1)</sup>													
Clear height of the tunnel	2031 (2113) <sup>1)</sup>													
Coverage height of the tunnel architrave 6 cm / architrave 8 cm	2102 / 2122 (2184 / 2204) <sup>1)</sup>													

<sup>1)</sup> standard PL2112



# STEEL FRAME

FOR PANEL, BOARD AND GLASS GRAF DOOR LEAVES

## ADJUSTABLE STEEL DOOR FRAME (OVERLAPPING), sheet metal thickness 1.5 mm

welded and painted in RAL 9003, 9010, 9016, 8003, 8017, 7016, 7022, 9005, 7047, 1001

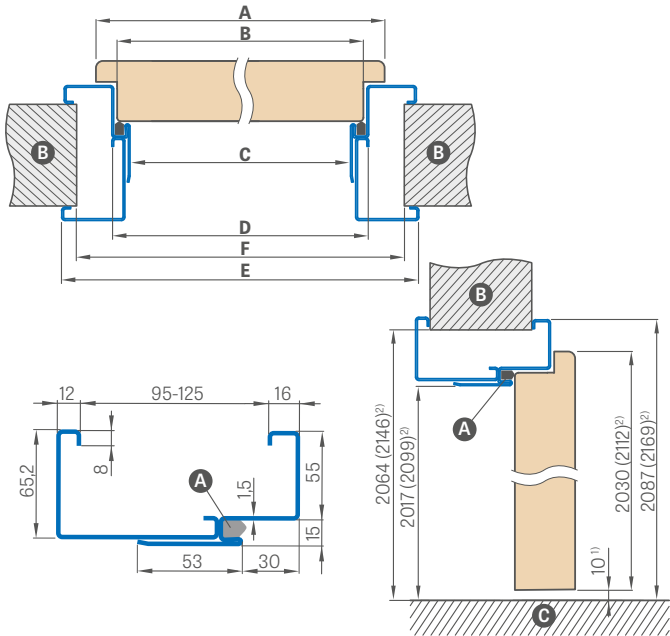

## LARGE SQUARE STEEL FRAME, sheet metal thickness 1.2 mm

welded and painted in RAL 9003, 9010, 9016, 8003, 8017, 7016, 7022, 9005, 7047, 1001

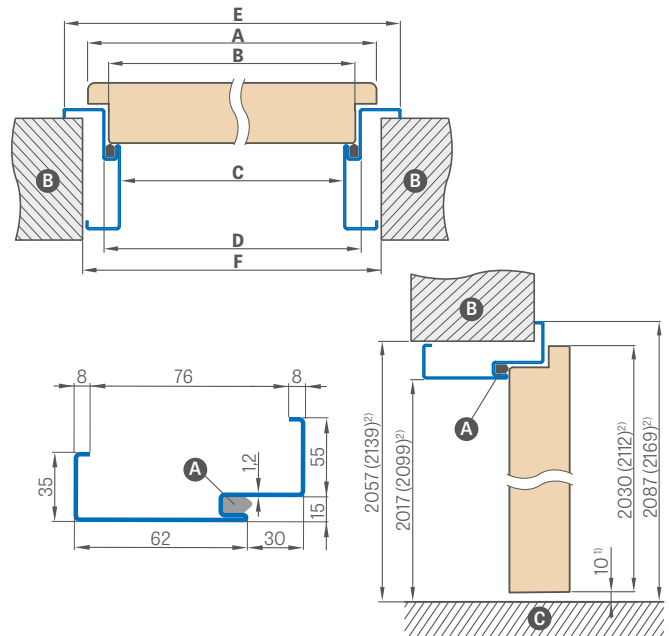

<sup>1)</sup> permissible deviation resulting from the dimensional tolerance of the frame  $\pm 3$ mm (we recommend checking before installation) <sup>2)</sup> standard 2112

Door width	A	B	C	D	E	F
"60"	644	617	601	631	741	695
"70"	744	717	701	731	841	795
"80"	844	817	801	831	941	895
"90"	944	917	901	931	1041	995
"100"	1044	1017	1001	1031	1141	1095
"110"	1144	1117	1101	1131	1241	1195

Door width	A	B	C	D	E	F
"60"	644	617	601	631	741	691
"70"	744	717	701	731	841	791
"80"	844	817	801	831	941	891
"90"	944	917	901	931	1041	991
"100"	1044	1017	1001	1031	1141	1091
"110"	1144	1117	1101	1131	1241	1191

Adjustment range min.-max (mm)	(RAL 9003, 9010, 9016, 8003, 8017, 7016, 7022, 9005, 7047, 1001)
95-125	
125-155	
155-185	
185-215	
215-245	
245-275	
275-305	

### RAL



### FITTING THE SQUARE FRAME

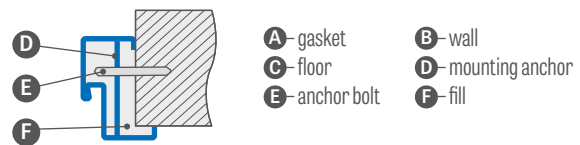

### EXTRA CHARGES

electric door strike	
reinforcement for door closer	
galvanised sheet steel	+10%
adjustable door frame "100" or "110"	
fixed door frame "100" or "110"	
frame for double-leaf doors	individual quotation
standard 2112	extra charge 15%
non-typical RAL (does not include rare, intense, pearlescent, and metallic colours)	extra charge 10%

<sup>1)</sup> at extra charge +10%

# STEEL FRAME

NON-REBATED, FOR STILE AND FLUSH DOOR LEAVES

## ADJUSTABLE STEEL FRAME WITHOUT REBATE (ENCLOSING), sheet thickness 1.5 mm

welded and painted in RAL 9003, 9010, 9016, 8003, 8017, 7016, 7022, 9005, 7047, 1001

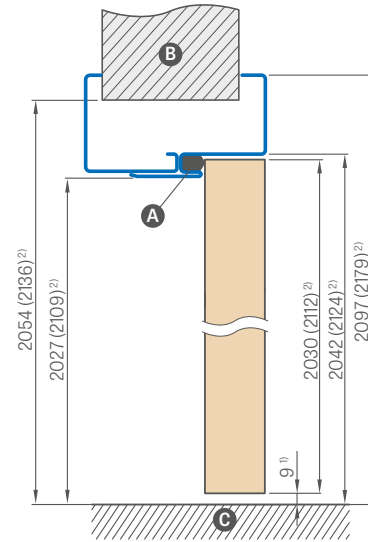
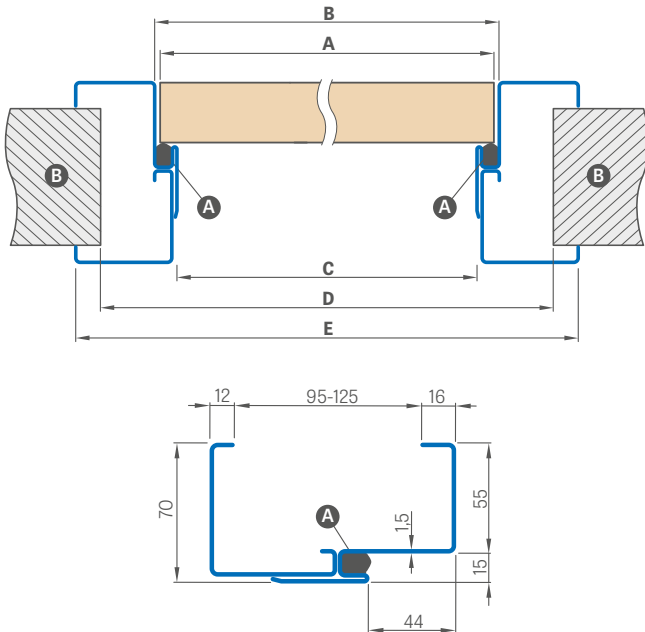

<sup>1)</sup> permissible deviation resulting from the dimensional tolerance of the frame  $\pm 3\text{mm}$  (we recommend checking before installation)

<sup>2)</sup> standard 2112

Adjustment range min.-max (mm)	(RAL 9003, 9010, 9016, 8003, 8017, 7016, 7022, 9005, 7047, 1001)
95-125	
125-155	
155-185	
185-215	
215-245	
245-275	
275-305	

Door width	A	B	C	D	E
"60"	644	650	620	710	760
"70"	744	750	720	810	860
"80"	844	850	820	910	960
"90"	944	950	920	1010	1060
"100"	1044	1050	1020	1110	1160
"110"	1144	1150	1120	1210	1260

**A** - gasket **B** - wall **C** - floor

Frames come standard with two hinges.

## EXTRA CHARGES

reinforcement for door closer

third hinge

galvanised sheet steel +10%

adjustable door frame "100" or "110"

standard 2112 extra charge 15%

non-typical RAL (does not include rare, intense, pearlescent, and metallic colours) extra charge 10%

## RAL



<sup>1)</sup> at extra charge +10%



# OVERLAY ADJUSTABLE FRAME

## FOR STEEL FRAME

### HANDLE POSITION IN THE OVERLAY FRAME

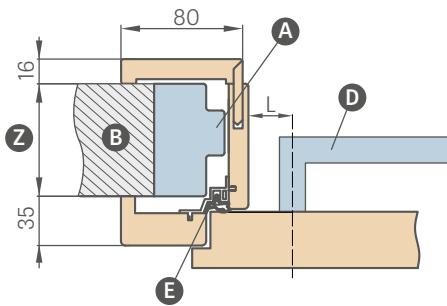

L – distance from the axis of the handle to the edge of the frame board  
L = 28 mm for stile and panel doors (all handles for interior doors from the offer available)

**NOTE:** Check the dimensions of the escutcheons in the handles before using them.  
An overlay frame with a range over 200 mm consists of two elements, and over 320 mm of three elements.

### AVAILABLE WIDTHS OF OVERLAY FRAMES:

60 70 80 90 100

Adjustment range min.-max (mm)	ADJUSTABLE OVERLAY FRAME	
	GREKO	ST CPL and PREMIUM
80-100		
100-120		
120-140		
140-160		
160-180		
180-200		
200-220		
220-240		
240-260		
260-280		
280-300		
300-320		
320-340		
340-360		
360-380		
380-400		
400-420		
420-440		

1 element

2 elements

3 elements

### OVERLAY FRAME DIAGRAM

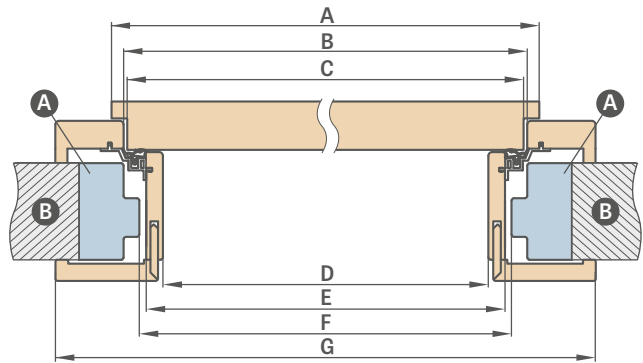

Door width	A	B	C	D	E	F	G
"60"	644	624	618	564	592	598	733
"70"	744	724	718	664	692	698	833
"80"	844	824	818	764	792	798	933
"90"	944	924	918	864	892	898	1033
"100"	1044	1024	1018	964	992	998	1133

F – minimum opening dimension of the steel frame on which the overlay frame is mounted. This dimension may be up to 20 mm greater than recommended. With increased opening, make sure the trims will adequately cover the wall.

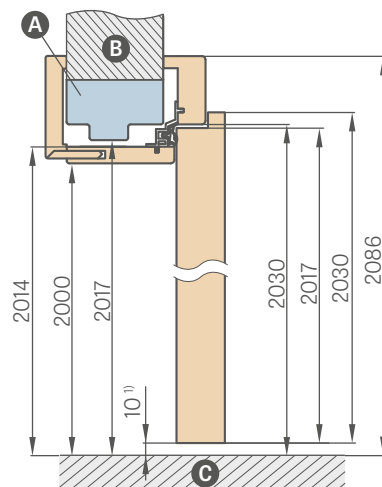

<sup>1)</sup> Permissible deviation resulting from the dimensional tolerance of the frame  $\pm 3$ mm (we recommend checking before installation)

- A** – steel frame
- B** – wall
- C** – floor
- D** – handle
- E** – profile with gasket
- Z** – range from 80 mm to 255 mm

- Extension 120 mm and 55 mm for overlay frame – extra charge (price includes a set for a frame of a given width)
- Clip-on square for overlay door frame – extra charges (the price includes a set for a door frame of a given width)
- Clip-on square with extended tongue – extra charges

- Prices for tunnel frames with widths 60, 70, 80, 90, 100 at the price of adjustable overlay frames
- The tunnel has the same dimensions as the overlay frame (no drilling for hinge and strike plate, but equipped with a gasket)
- Price of frame for double-leaf doors + 30%

# REVERSIBLE DOOR FRAME

## REVERSIBLE DOOR LEAVES

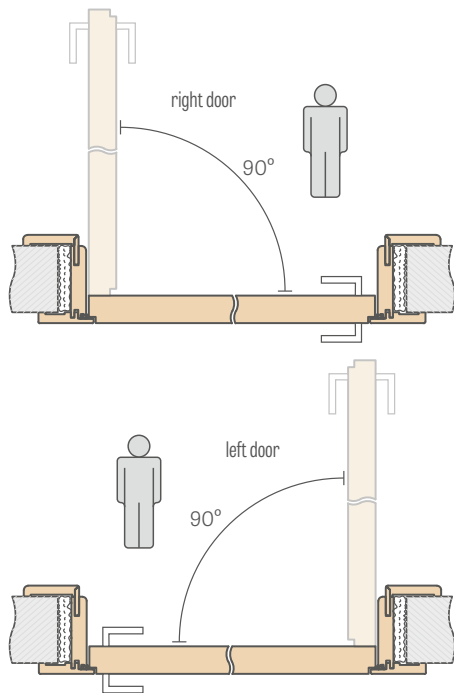

### ADJUSTMENT RANGE OF THE REVERSIBLE FRAME

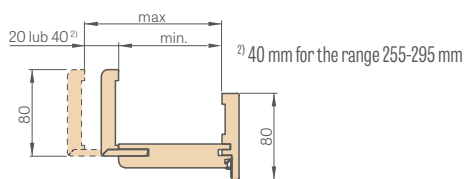

Adjustment range min.-max (mm)	REVERSIBLE DOOR FRAME		
	GREKO	ST CPL and PREMIUM	UV LACQUER
75-95			
95-115			
115-135			
135-155			
155-175			
175-195			
195-215			
215-235			
235-255			
255-295			
295-315			
315-335			
335-355			

1 element

2 elements

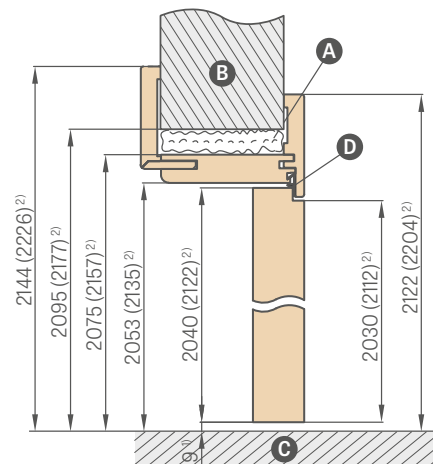
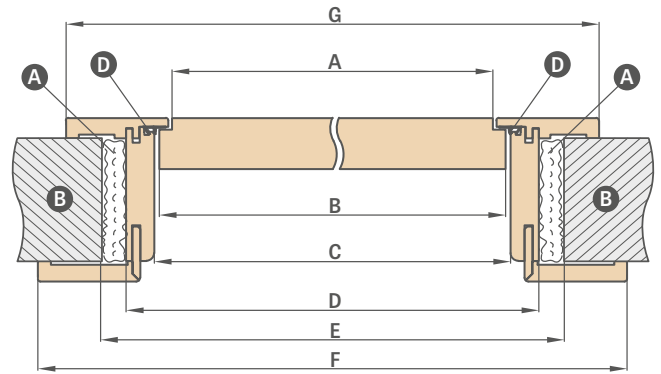

<sup>1)</sup> permissible deviation resulting from the dimensional tolerance of the frame  $\pm 3$ mm (we recommend checking before installation)

<sup>2)</sup> standard PL2112

A-foam B-wall C-floor D-rubber gasket

Door width	A	B	C	D	E	F	G
"60N" <sup>3)</sup>	600	620	628	672	700	810	766
"60"	624	644	652	696	736	834	791
"70N" <sup>3)</sup>	700	720	728	772	800	910	866
"70"	724	744	752	796	836	934	891
"80N"	800	820	828	872	900	1010	966
"80"	824	844	852	896	936	1034	991
"90N" <sup>3)</sup>	900	920	928	972	1000	1110	1066
"90"	924	944	952	996	1036	1134	1091
"100"	1024	1044	1052	1096	1136	1234	1191
"110"	1124	1144	1152	1196	1236	1334	1291

<sup>3)</sup> Widths 60N, 70N, 90N available only for models ALTAMURA 1, BALDUR 1 and UNO PREMIUM

**NOTE:** Choosing a set (crosshead + pilasters) for the adjustable reversible frame reduces the working range of the frame by 3 mm (for single-sided use) or 6 mm (for double-sided use). Example: for a wall thickness of 140 mm with a single-sided set, assume it is 143 mm, and for double-sided, 146 mm, and select the corresponding wall coverage range from the table for rebated (p. 186), non-rebated (p. 184), or reversible frames (p. 183).

- The frame for reversible door leaves is standardly available with a bracket 8 cm joined at a 45-degree angle or, for an extra charge, joined at a 90-degree angle (not available in the range 75-95mm)
- The frame includes two so-called concealed hinges invisible when the door leaf is closed, or optionally a third hinge for an extra charge
- Available decors from the color group: GREKO, PREMIUM, ST CPL and UV lacquer
- Change to hinges and strike plate in black, white or gold - extra charge / set for the frame
- Change of range by +20 mm (available in ranges from 135-155 mm to 235-255 mm) - extra charge

- Extension 120 mm and 55 mm for laminated and lacquered reversible frame - extra charge (price includes a set for a frame of a given width)
- Movable clip-on square with a 2 cm extended tongue and standard clip-on square for adjustable door frames available in all laminates and varnishes - **extra charges** (the price includes a set for a door frame of a given width)
- A frame with a range above 295 mm consists of two elements
- Top panels glued to the wall for an extra charge p. 156
- Standard PL2112 extra charge 15%

# ADJUSTABLE FRAME

## NON-REBATED DOOR LEAVES

### ADJUSTABLE FRAME RANGE 80-95mm

architrave 6 cm / architrave 8 cm

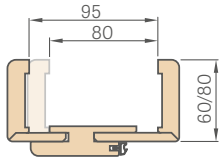

In a frame with a range of 80-95mm, the bracket tongue must be cut to the required range by yourself

### FRAME CONNECTION

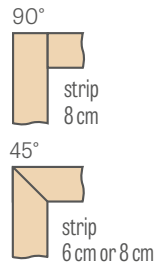

### ADJUSTABLE FRAME ADJUSTMENT RANGE

architrave 6 cm / architrave 8 cm

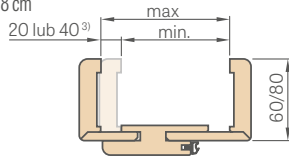

<sup>3)</sup> 40 mm for the range 295-335 mm

Adjustment range min.-max (mm)	ADJUSTABLE DOOR FRAME architrave 6 cm and 8 cm			
	GREKO	ST CPL and PREMIUM	CPL 0.2	UV LACQUER
80-95				
95-115				
115-135				
135-155				
155-175				
175-195				
195-215				
215-235				
235-255				
255-275				
275-295				
295-315				
315-355				
355-375				
375-395				
395-415				

1 element  
2 elements

### ADJUSTABLE FRAME DIAGRAM

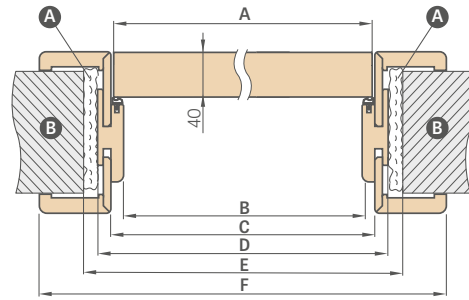

Door width	A	B	C	D	E	F
"60N" <sup>3)</sup>	620	605	627	649	688	747*/787**
"60"	644	629	651	673	714	771*/811**
"65"	695	680	702	724	764	822*/862**
"70N" <sup>3)</sup>	720	705	727	749	788	847*/887**
"70"	744	729	751	773	814	871*/911**
"75"	795	780	802	824	864	922*/962**
"80N"	820	805	827	849	888	947*/987**
"80"	844	829	851	873	914	971*/1011**
"85"	895	880	902	924	964	1022*/1062**
"90N" <sup>3)</sup>	920	905	927	949	988	1047*/1087**
"90"	944	929	951	973	1014	1071*/1111**
"95"	995	980	1002	1024	1064	1122*/1162**
"100"	1044	1029	1051	1073	1114	1171*/1211**
"110"	1144	1129	1151	1173	1214	1271*/1311**

\* architrave 6 cm / \*\* architrave 8 cm

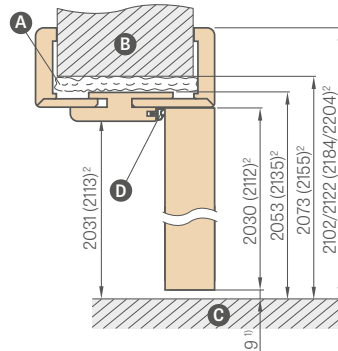

<sup>1)</sup> Permissible deviation resulting from the dimensional tolerance of the frame ±3mm (we recommend checking before installation)

<sup>2)</sup> standard PL2112 with a 15% surcharge

<sup>3)</sup> widths 60N, 70N, 90N available only for model ALTAMURA 1, BALDUR 1 and UNO PREMIUM

- A** – foam
- B** – wall
- C** – floor
- D** – rubber gasket

**NOTE: Choosing a set (crosshead + pilasters) for a non-rebated adjustable door frame reduces the working range of the frame by 3 mm (for single-sided use) or 6 mm (for double-sided use). Example: for a wall thickness of 140 mm with a single-sided set, you should assume it is 143 mm, and with a double-sided set, it is 146 mm and select the corresponding wall coverage range from the table for rebated frames (p. 186), non-rebated (p. 184), or reverse (p. 183).**

- AquaStop hybrid waterproof frame (available in PL and CZ standards only in decors ST CPL and PREMIUM and only for architrave 8 cm joined at a 45-degree angle<sup>4)</sup> – surcharge
- Frame in standard PL2112 + 15% to the frame price before surcharges<sup>5)</sup>
- The non-rebated adjustable door frame in CPL 0.2 is also used in sets with door leaves in CPL 0.7
- Change to hinges and strike plate in black, white, or gold – surcharge/ set for the frame
- 90-degree connection possible only in a frame with architrave 8 cm. Surcharge for 90-degree connection<sup>5)</sup>
- A frame with a range above 335 mm consists of two elements
- Price of adjustable door frame for double-leaf doors + 30%
- Extension 120 mm and 55 mm for laminated non-rebated frame and CPL 0.2 and lacquered – surcharge (the price includes a set for a frame of a given width) 5)
- Extension 120 mm for AquaStop frame<sup>4)</sup> – surcharge (includes a set for a frame of a given width)
- Movable angle bar with a 2 cm extended tongue and standard angle bar for adjustable door frame available in all laminates and CPL 0.2 and lacquer surcharge – surcharge (the price includes a set for a frame of a given width) – applies to the solution with architrave 6 cm and architrave 8 cm 5)
- Standard movable clip-on square, 8 cm, 45-degree connection angle for AquaSt door frame<sup>4)</sup> – extra charges
- Prices of tunnel frame with width 60, 65, 70, 75, 80N, 80, 85, 90, 95, 100 at the price of a rebated adjustable door frame (see table p. 187)
- Prices of tunnel frame with width 110, 120, 130, 140, 150, 160, 170, 180, 190 at the price of a rebated adjustable door frame for double-leaf doors (see table p. 187)
- Top panels glued to the wall (only with frame with 8 cm angle bar) – p. 156
- Electric door strike (available only for latch bolt locks) – extra charges
- Change of range by +20 mm (available in ranges from 135-155 mm to 295-315 mm)<sup>5)</sup> – surcharge
- The frame includes two so-called concealed hinges invisible when the door leaf is closed, or optionally a third hinge for an extra charge

<sup>4)</sup> available from 01.02.2026<sup>5)</sup> not available in AquaStop frame

# FIXED DOOR FRAME

## REBATED DOOR LEAVES

### FIXED DOOR FRAME

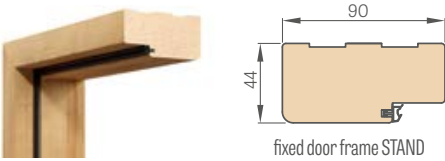

GREKO	
ST CPL and PREMIUM	
CPL 0.2	
UV LACQUER	

### COVER PROFILE 8 mm

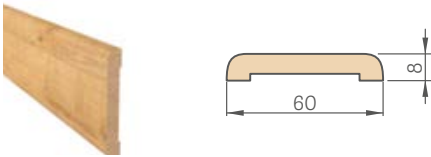

GREKO	
ST CPL and PREMIUM	
CPL 0.2	
UV LACQUER	

The price includes a set of 2 pcs x 213.5 cm and 1 pc x 112 cm (applies to door leaves from "60" to "90")  
The price includes a set of 3 pcs. x 213.5 cm (applies to door leaves from "100" to "190")

### QUARTER ROUND



GREKO	
ST CPL and PREMIUM	
UV LACQUER	

The price includes a set of 2 pcs x 211.5 cm and 1 pc x 106.5 cm (applies to door leaves from "60" to "90")  
The price includes a set of 3 pcs. x 211.5 cm (applies to door leaves from "100" to "190")

### ELECTRIC DOOR STRIKE

Technical specification on p. 153



### SKIRTING BOARD length 2.40 m

- laminated
- lacquered

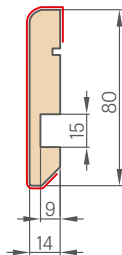

- The skirting board is made of moisture-resistant MDF board. Available: LACQUER UV, laminates: GREKO, ST CPL, PREMIUM and in primer laminates for painting..
- Installation method - gluing to the wall

### CLIP-ON SQUARE 6 cm and 8 cm (set includes 3 clips)



GREKO	
ST CPL and PREMIUM	
CPL 0.2	
UV LACQUER	
AquaStop ST CPL and PREMIUM <sup>1)</sup>	

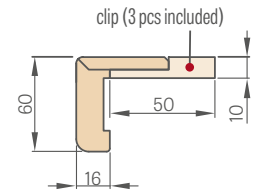
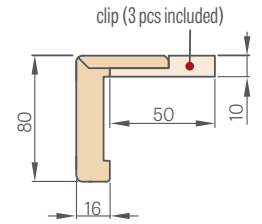

### COVER PROFILE 16 mm

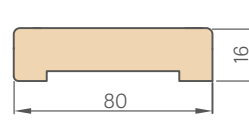

GREKO	
ST CPL and PREMIUM	
CPL 0.2	
UV LACQUER	

The price includes a set of 2 pcs x 214.5 cm and 1 pc x 112 cm (applies to door leaves from "60" to "80")  
The price includes a set of 3 pcs. x 214.5 cm (applies to door leaves from "90" to "180")

### FIXED FRAME STAND DIAGRAM

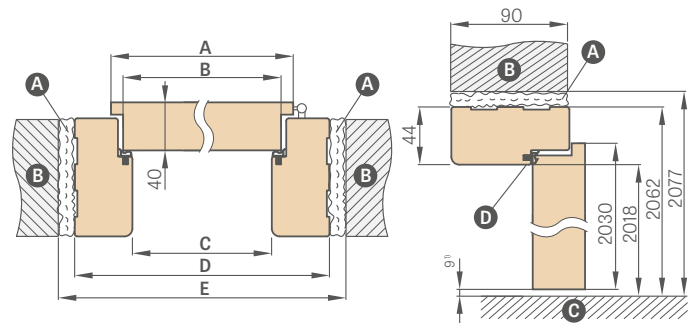

<sup>1)</sup> Permissible deviation resulting from the dimensional tolerance of the frame  $\pm 3$ mm (we recommend checking before installation)

Door width	A	B	C	D	E
"60"	644	618	604	692	722
"65"	695	669	655	743	773
"70"	744	718	704	792	822
"75"	795	769	755	843	873
"80"	844	818	804	892	922
"85"	895	869	855	943	973
"90"	944	918	904	992	1022
"95"	995	969	955	1043	1073
"100"	1044	1018	1004	1092	1122
"110"	1144	1118	1104	1192	1222

Ⓐ- foam Ⓑ- wall Ⓒ- floor Ⓓ- rubber gasket

- Fixed frame for double-leaf doors + 30 %
- Non-rebated fixed door frame – not available
- The fixed door frame, band, and clip-on square in CPL 0.2 are also used in combination with door leaves in CPL 0.7.
- Black strike plate available only for GRAF glass door frame – surcharge

<sup>1)</sup> only for architrave 8 cm joined at a 45-degree angle



# ADJUSTABLE FRAME

## REBATED DOOR LEAVES



Adjustable door frame with a range above 340 mm

An adjustable door frame with a range above 340 mm consists of two elements.

### ADJUSTABLE FRAME ADJUSTMENT RANGE

architrave 6 cm / architrave 8 cm

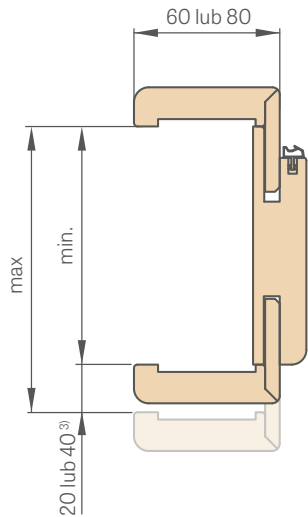

<sup>3)</sup> 40 mm for the range 300-340 mm

In a door frame with a range of 65-80 mm, the angle bar tongue must be cut by yourself to the required range

### DOOR FRAME JOINTS

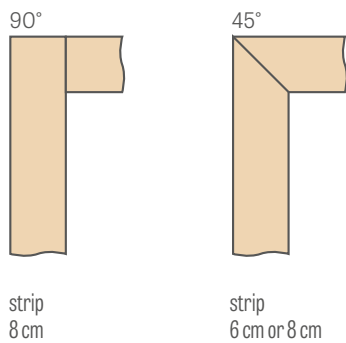

installation video:  
<https://youtu.be/habWxYCI98c>

### ADJUSTABLE DOOR FRAME DIAGRAM

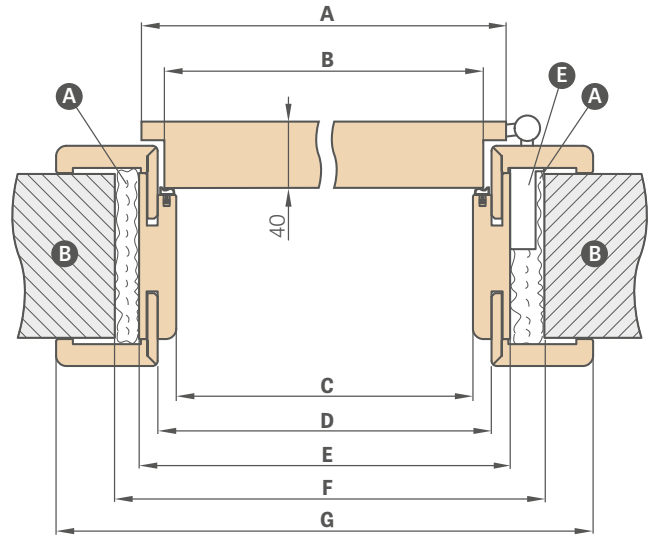

Door width	A	B	C	D	E	F	G
"60"	644	618	604	626	648	688	746*/786**
"65"	695	669	655	677	699	739	797*/837**
"70"	744	718	704	726	748	788	846*/886**
"75"	795	769	755	777	799	839	897*/937**
"80"	844	818	804	826	848	888	946*/986**
"85"	895	869	855	877	899	939	997*/1037**
"90"	944	918	904	926	948	988	1046*/1086**
"95"	995	969	955	977	999	1039	1097*/1137**
"100"	1044	1018	1004	1026	1048	1088	1146*/1186**
"110"	1144	1118	1104	1126	1148	1188	1246*/1286**

\* architrave 6 cm / \*\* architrave 8 cm

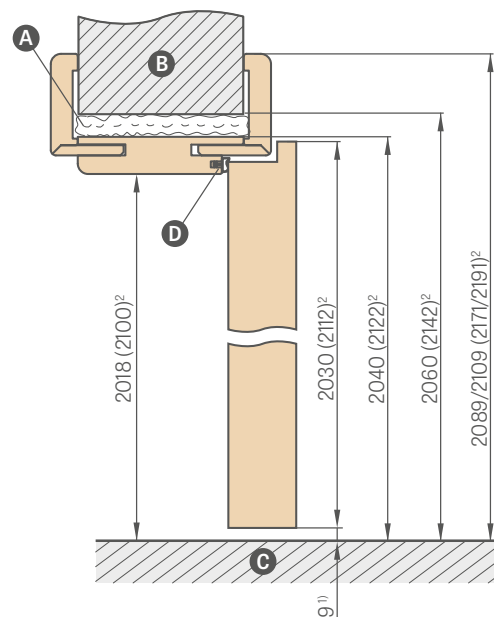

<sup>1)</sup> permissible deviation resulting from the dimensional tolerance of the frame  $\pm 3$ mm (we recommend checking before installation)

<sup>2)</sup> standard PL2112 with a 15% surcharge

**A** - foam **B** - wall **C** - floor **D** - rubber gasket **E** - hinge socket

Adjustment range min.-max (mm)	ADJUSTABLE FRAME and TUNNEL architrave 6 cm and 8 cm			
	GREKO	ST CPL and PREMIUM	CPL 0.2	UV LACQUER
65-80				
80-100				
100-120				
120-140				
140-160				
160-180				
180-200				
200-220				
220-240				
240-260				
260-280				
280-300				
300-340				
340-360				
360-380				
380-400				
400-420				

1 element

2 elements

**NOTE: Choosing a set (crosshead + pilasters) for a rebated adjustable door frame reduces the working range of the frame by 3 mm (for single-sided use) or 6 mm (for double-sided use). Example: for a wall thickness of 140 mm, with a single-sided set you should assume it is 143 mm, and with a double-sided set, 146 mm, and select the corresponding wall coverage range from the table for rebated frames (p. 186), non-rebated (p. 184), or reverse (p. 183).**

- AquaStop hybrid waterproof door frame (available in PL and CZ standards only in decors ST CPL and PREMIUM and only for architrave 8 cm joined at a 45-degree angle – surcharge
- Door frame in standard PL2112 +15% to the price of the frame before surcharges<sup>1)</sup>
- The rebated adjustable door frame in CPL 0.2 is also used in sets with door leaves in CPL 0.7
- Joining at a 90-degree angle is only possible in a frame with an architrave 8 cm. Surcharge for joining at a 90-degree angle<sup>1)</sup>
- Electric door strike – extra charge
- Reinforcement for door closer – surcharge
- Price of fixed and adjustable door frame for double-leaf doors + 30%
- Movable clip-on square with a 2 cm extended tongue and standard clip-on square for adjustable door frames available in all laminates, CPL 0.2, and lacquer – extra charges (price includes a set for a door frame of a given width) – applies to architrave 6 cm and architrave 8 cm<sup>1)</sup>
- Standard movable clip-on square, 8 cm, 45-degree connection angle for AquaStop door frame – extra charges
- Black or white strike plate available only for GRAF glass door frames – surcharge
- Extension 120 mm and 55 mm for laminate adjustable door frame as well as CPL 0.2 and lacquered – surcharge (the price includes a set for a frame of a given width)<sup>1)</sup>
- Extension 120 mm for AquaStop frame – surcharge (includes a set for a frame of a given width)
- It is possible to make frames for a range of 500-520 mm – surcharge for each 2 cm of range, based on the price of the 400-420 mm frame
- Prices of tunnel frames for rebated and non-rebated door leaves with widths 60, 65, 70, 75, 80N (only non-rebated), 80, 85, 90, 95, 100 at the price of an adjustable door frame for rebated door leaves
- Prices of tunnel frames for rebated and non-rebated door leaves with widths 110, 120, 130, 140, 150, 160, 170, 180, 190 at the price of an adjustable door frame for double-leaf rebated doors
- Top panels glued to the wall (only with a frame with 8 cm angle bar) – p. 156
- Change of range by +20 mm (available in ranges from 120-140 mm to 280-300 mm)<sup>1)</sup> – surcharge

The warranty card and installation instructions are included with the product.  
 This catalogue serves as an illustrative informational material and contains current prices and current product availability.  
 The manufacturer reserves the right to change prices and available goods without prior notice.  
 Color samples may differ in reality from those presented in this catalog. Please consult colours with the original samples available at our distributors.  
 The photos in the catalog are for reference only and with different door leaf widths, the dimensional proportions of individual elements may vary.  
 We reserve the right to printing errors.  
 The catalogue does not constitute an offer within the meaning of the law and is published for informational purposes only.

Version I/2026/A is valid from 1.1.2026.

The choice of doors should be based on the technical design of the facility, prepared taking into account the applicable standards and regulations as well as the intensity and conditions of use. ERKADO offers several variants, but their selection is left to the Buyer, as only the Buyer or a person acting on their behalf knows the purpose and conditions of use of the ordered product

Approvals and certificates available for download from the website [www.erkado.pl](http://www.erkado.pl)

<sup>1)</sup> not available in AquaStop frame

**ERKADO**  
doors are our world

# STEEL DOORS



**ERKADO Sp. z o.o.**

Gościeradów-Folwark  
Osiedle POM 8  
23-275 Gościeradów  
Poland  
NIP 715-194-27-90

e-mail: [biuro@erkado.pl](mailto:biuro@erkado.pl)  
[www.erkado.pl](http://www.erkado.pl)

CHECK PRICES

STEEL DOORS



INTERIOR DOORS



**BEHIND OUR DOORS YOU WILL FEEL SAFE**

**FUNCTIONALITY • SAVINGS • AESTHETICS**



**SECURITY**  
burglar resistance class  
RC2



Ud od 0,6 W/(m<sup>2</sup>K)

**THERMAL EFFICIENCY**  
compliant with requirements  
of the "Clean Air" program



**DURABILITY**  
high resistance  
to weather conditions